

# COYOTE<sup>®</sup> MDC-V2

Fiber Optic Closure

# STANDARD TERMS AND CONDITIONS OF BUSINESS

## 1. APPLICATION OF CONDITIONS

These terms and conditions shall govern, and control all offers and sales by PREFORMEDLINE PRODUCTS (SOUTH AFRICA) (PTY) LTD. (herein called "PLP"). Unless expressly accepted in writing signed at its head office in Pietermaritzburg by an authorised signatory, any qualification of these conditions in a customer's order or enquiry, or anything contrary to or conflicting with any of these conditions shall be treated as inapplicable and of no effect.

## 2. ACCEPTANCE

Any tender or quotation by PLP only applies for thirty days from date thereof; and no order shall bind PLP until the customer shall receive written confirmation thereof from PLP, duly signed on behalf of PLP.

## 3. PRICES

All prices are nett, F.O.R. Works at Pietermaritzburg and subject to change without notice. Value Added Tax (VAT) is not included and will be added-on where applicable.

## 4. FINANCIAL RESPONSIBILITY

The customer's financial responsibility is at all times subject to approval of PLP's credit department and PLP at any time may require payment in advance for a satisfactory security or guarantee that invoices will be paid promptly when due. If the customer fails to comply with any term of payment, PLP reserves the right to withhold further deliveries or to terminate the agreement and any unpaid amount thereupon shall become due immediately.

## 5. TERMS OF PAYMENT

Unless otherwise specifically agreed between PLP and the customer in writing, The customer shall pay PLP immediately on presentation of an invoice before delivery, without deduction or set-off, and payments shall not be withheld or deferred on the basis of any claims as alleged by the customer against PLP.

## 6. DELIVERY

The PLP will use its best endeavours to deliver the products by the time fixed for delivery, but if from any cause other than the wilful default of PLP delivery is delayed, PLP will not be responsible for any loss or damage thereby caused to the customer. Failure of one delivery shall not vitiate the contract as to others. No responsibility is accepted for delays due to loss in manufacturing or for damage and/or other delays due to Act of God, War, Fire, Civil Commotion, Accidents, and for other causes beyond PLP's control. Offers of delivery from stock are subject to the fitting being unsold on receipt of order.

## 7. DELIVERY CHARGES

Unless otherwise agreed in writing or stated in the confirmation of the order, delivery charges are for the customer's account.

## 8. WARRANTY

PLP warrants that all products manufactured and /or supplied by PLP are free from defects in material and workmanship under normal and proper usage for a period of one year from the date of delivery. Products must be installed and maintained to PLP's recommended procedures, and subject to the provisions of clause 9 below that in the event of breach of this warranty, PLP's liability will be limited to the free replacement only of the products provided such defect is proved to be directly attributable to defective materials or workmanship and subject to a claim being received by PLP in writing within 14 (Fourteen) days of such defect. This warranty is exclusive and in lieu of all other warranties, whether express, implied or otherwise arising by operation of law, trade, or course of dealing. In addition, the remedies set forth herein are the sole and exclusive remedies. PLP shall not be liable for any consequential or incidental damages of any kind.

## 9. LIABILITY

The liability of PLP for any loss or damage, including special, general, direct or consequential, in respect of any claim arising out of any contract entered into with a customer in connection with the manufacture and /or the sale and/or the supply and/or the delivery of our products, whether such claim shall be for breach of any statutory duty or for any delict (including the negligence of our employees or servants) shall not exceed the sale price of the relevant products sold to the customer. In addition, under no circumstance will PLP be liable for any costs associated with fires and wildfires including costs for clean-up efforts.

## 10. PACKING

All goods are packed in PLP's standard corrugated cartons, wooden crates and/or suitable alternatives at PLP's discretion.

## 11. LOSS OR DAMAGE IN TRANSIT

PLP is not responsible for this risk. In the case where PLP has accepted transit risk in terms of clause 1 of these conditions, transit loss or damage must be reported by the customer or consignee immediately in writing to the carrier, and also to PLP. Documentary evidence, as prescribed by the CARRIERS must be given by the consignee to PLP within seven days of receipt of the consignment in question.

## 12. TESTING AND INSPECTION

When testing and inspection is specified by customers and agreed to by PLP, PLP shall test/inspect at its Works in a suitable area designated by PLP.

## 13. DEVIATION IN QUANTITIES MANUFACTURED

Products manufactured are subject to a deviation of plus minus 10% in quantity.

## 14. STANDARD PACKS

PLP reserves the right to supply in increments its standard packs.

## 15. CANCELLATION

The customer shall not be entitled to cancel or repudiate any order or refuse to accept delivery of any order and/or claim damages or set-off as a consequence of late or short delivery.

# STANDARD TERMS AND CONDITIONS OF BUSINESS

## 16. RETURNS

No product shall be returned without PLP's prior written authorization. Only non-obsolete standard items in original cartons may be returned. Carriage must be prepaid. Requests for return must be instituted within 90 days of original delivery and returns will be subject to factory inspection before acceptance and credit authorization. PLP reserves the right to apply a minimum servicing charge of 10% of the invoice amount..

## 17. SPECIFICATIONS

PLP reserves the right to change specifications without prior notice.

## 18. OWNERSHIP AND RISK

Notwithstanding the delivery of any product to a customer, ownership of the product shall not pass to the customer until PLP has received payment in full of the contract price of the said product. Risk in the product shall pass to the customer on delivery.

## 19. COSTS

Should PLP incur legal costs regarding litigation with the customer or for the collection of any amount due by the customer, the customer shall pay such costs on the attorney-and-client scale as well as collection costs calculated at 10% (TEN PERCENT) of each and every payment made.

## 20. CONFIDENTIALITY

The customer agrees that all information furnished by or obtained from PLP in connection with the sale of goods hereunder will be confidential, and the Buyer agrees not to disclose any such information to any other person, or use such information for any purpose, other than performing this contract.

## 21. MISCELLANEOUS

The failure of either party to insist upon performance of any term or condition herein or to exercise any right or privilege shall not thereafter waive the future performance of such term, condition, right of privilege or of any other terms, conditions, rights or privileges, whether of the same or similar type. The rights herein and the construction of these Terms and Conditions shall be governed by the laws of the Republic of South Africa, without giving effect to principles of conflict of laws, invalid or unenforceable, the remaining provisions shall not be affected thereby, but shall remain in full force and effect. The paragraph headings herein are solely for the convenience of and reference by the parties and do not constitute any part of these Terms and Conditions. The customer may not assign its rights or delegate its obligations hereunder without PLP's prior written consent.

## 22. FOREIGN LAW

Save for these terms and conditions being governed by the laws of the Republic of South Africa, PLP complies with the Foreign Corrupt Practices Act (FCPA) Customer agrees that it will comply with all relevant laws, and will comply with all laws regarding bribery including, but not limited to, FCPA.

## 23. PATENT

PLP shall defend the customer against any claim of infringement and shall pay any resulting damages finally awarded, provided that (a) the customer promptly notifies PLP in writing of any claim, and (b) PLP has sole control of the defence and all related settlement negotiations. This obligation does not apply to claims arising out of combinations of goods with goods provided by others, or to claims resulting from compliance of goods with the customer's design or specifications, or which the customer assumes and shall hold PLP harmless for any claims thereof.

## ABOUT PLP

PLP (Preformed Line Products) protects the world's most critical connections by creating stronger and more reliable networks. Our precision-engineered solutions are trusted by energy and communications providers worldwide to perform better and last longer. With offices and manufacturing facilities in over 20 countries, PLP works as a united global corporation, delivering high-quality products and unparalleled service to customers around the world.





## SALES CONTACTS



**COMMUNICATIONS  
SALES**



**MDC INSTALLATION  
INSTRUCTIONS**

## CUSTOMER SUPPORT

### **PLP SOUTH AFRICA CUSTOMER & TECHNICAL SUPPORT**

Tel: 033 397 5800

Fax: 033 387 7094

Email: [plppmb@preformedsa.co.za](mailto:plppmb@preformedsa.co.za)

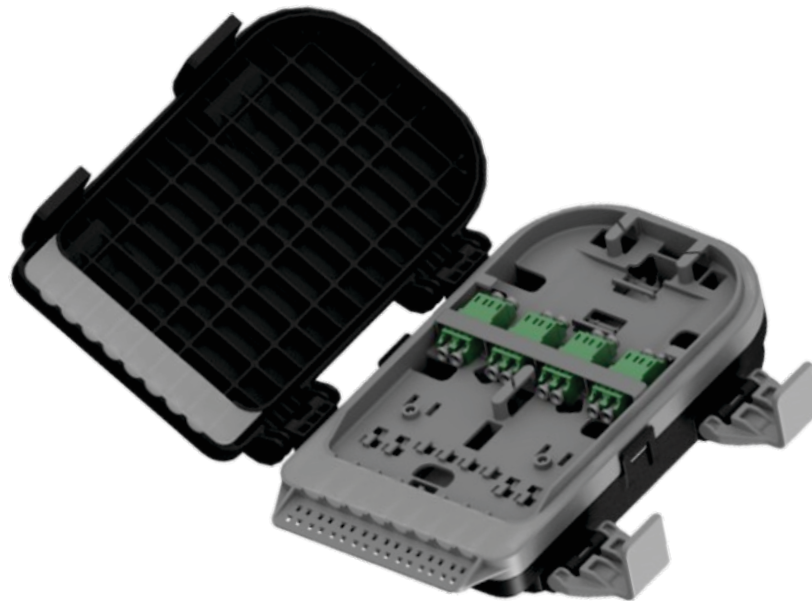

## COYOTE® MDC-V2

The **MDC-V2 (Multi-Drop Closure)** is a highly reliable, small-scale, cost-effective closure which provides a flexible alternative to traditional network interface devices. The closure has a robust latch system, paired with an integrated over moulded seal. This allows for effortless re-entry and creates a secure seal over a wide range of cable profiles. By manufacturing from high strength materials and subjecting to stringent thermocycle and ingress protection tests, The MDC is a built-to-last closure protecting fibre optic splices from water ingress.

### Features and Benefits

- **Dimensions:** 200mm x 135mm x 50mm (H x W x D)
- **Maximum Splice Capacity:**
  - 72 Single Fusion
  - Multiple Micro PLC Splitter options
  - FTP splice tray system- 12 Splices Per Tray
  - Supports 4x Duplex SC or 4x LC/Duplex( Housed in Clip in Bulkhead)
- **Port Quantity: 8**
  - (4)\* Feeder Ports ( Up to 8mm cable diameter
  - (8) Drop/Branch cable Ports (Up to 6mm cable diameter)

Note\*: For diameter above 6mm, only two ports should be used if an IP-68 rating is required



## COYOTE®MDC-V2

### Key Features:

- One size fits all seal (Max cable diameter 8mm)
  - Universal IP 68 sealing system suitable for underground and aerial applications.
  - 4-port entry with 8-port drop/branch
  - More visually appealing design
  - Splice Capacity 12-72 splice customizable
  - 4 Connectors for pre-con builds
  - Separate splice area for drop/branch cables.
- 
- New silicon seal (large range/no need for slitting)
  - Tested in accordance to GR-771 CORE and IP-68 rated requirements
  - Direct buried, below grade, pole/wall mount, aerial, pedestal
  - Constructed with UV/FR stabilized material
  - Range of internal fiber organizer to support splice, GPON (PLC splitter) and drop applications
  - Std STP latch system provides quick access with no special tools required to enter

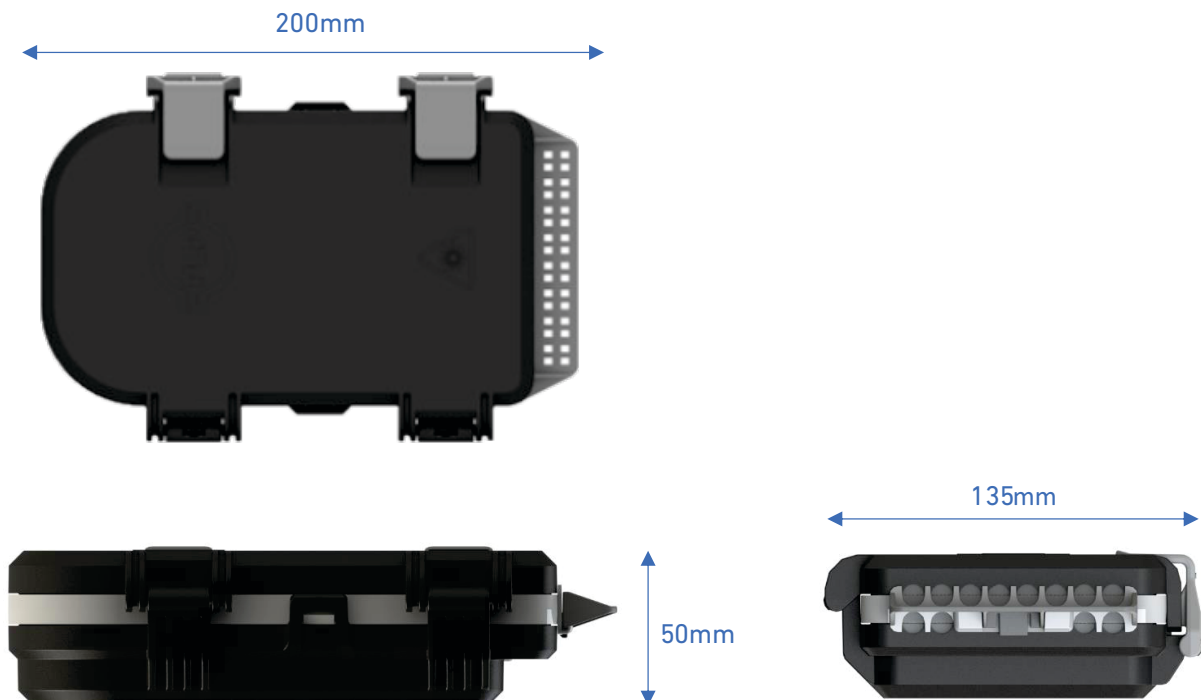

# COYOTE®MDC-V2

Drop side separate from Splice side to avoid tampering with Splitter and Splices when customer drop cables are added later. Original Version only housed Mid-couplers, New version now accommodates slicing as well

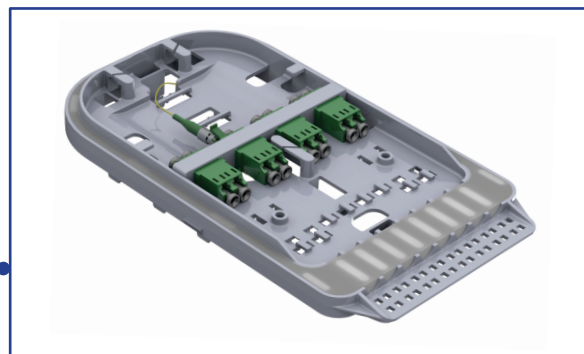

Upgraded Pre-con Version

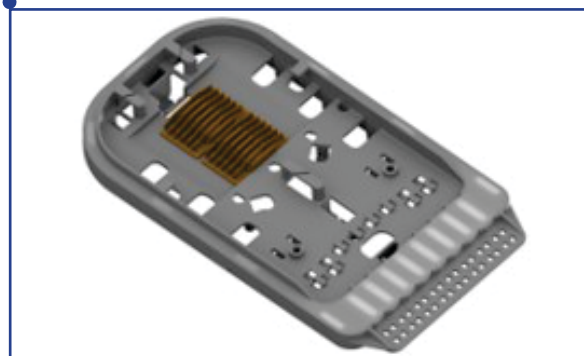

Upgraded Splice Version

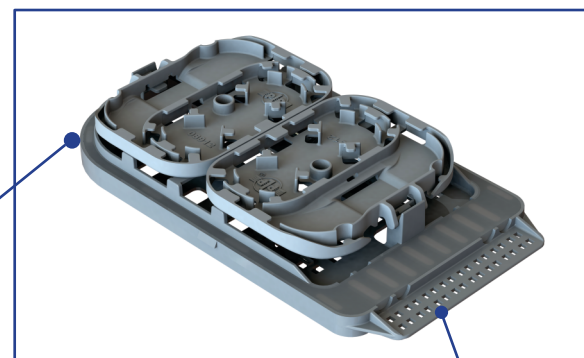

Upgraded Feeder Slide

New Integrated External Cable Fixation bracket

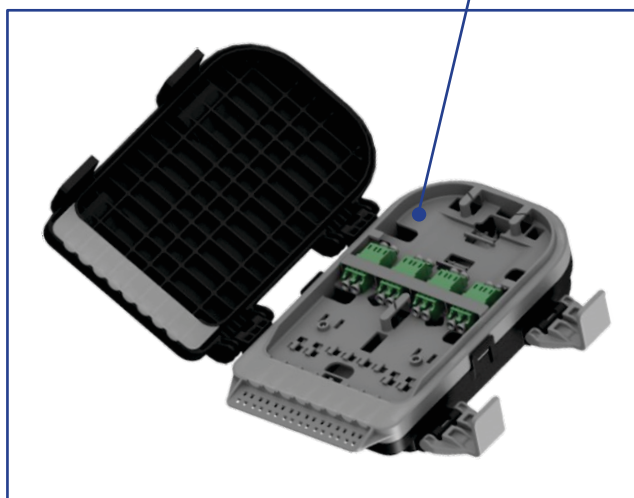

Splice/Splitter side can accommodate 4x Cable Entries ( 2x Cable Looped).  
Can store up to a total of 2 meters 2.5mm loose buffer tube below 12F trays.



# COYOTE®MDC-V2

## Feeder/Splice side-No trays: Improved Cable Fixation features

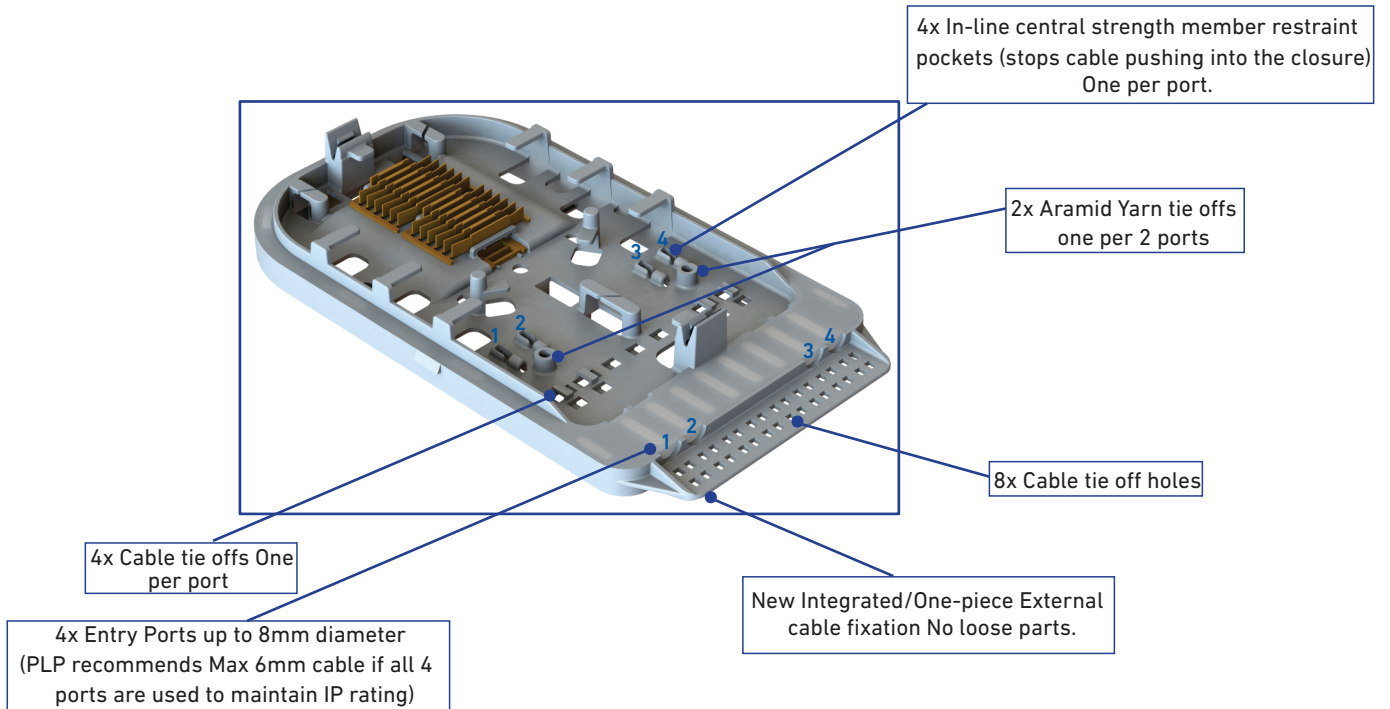

## Feeder/Splice side-No trays: Improved Fibre Management features

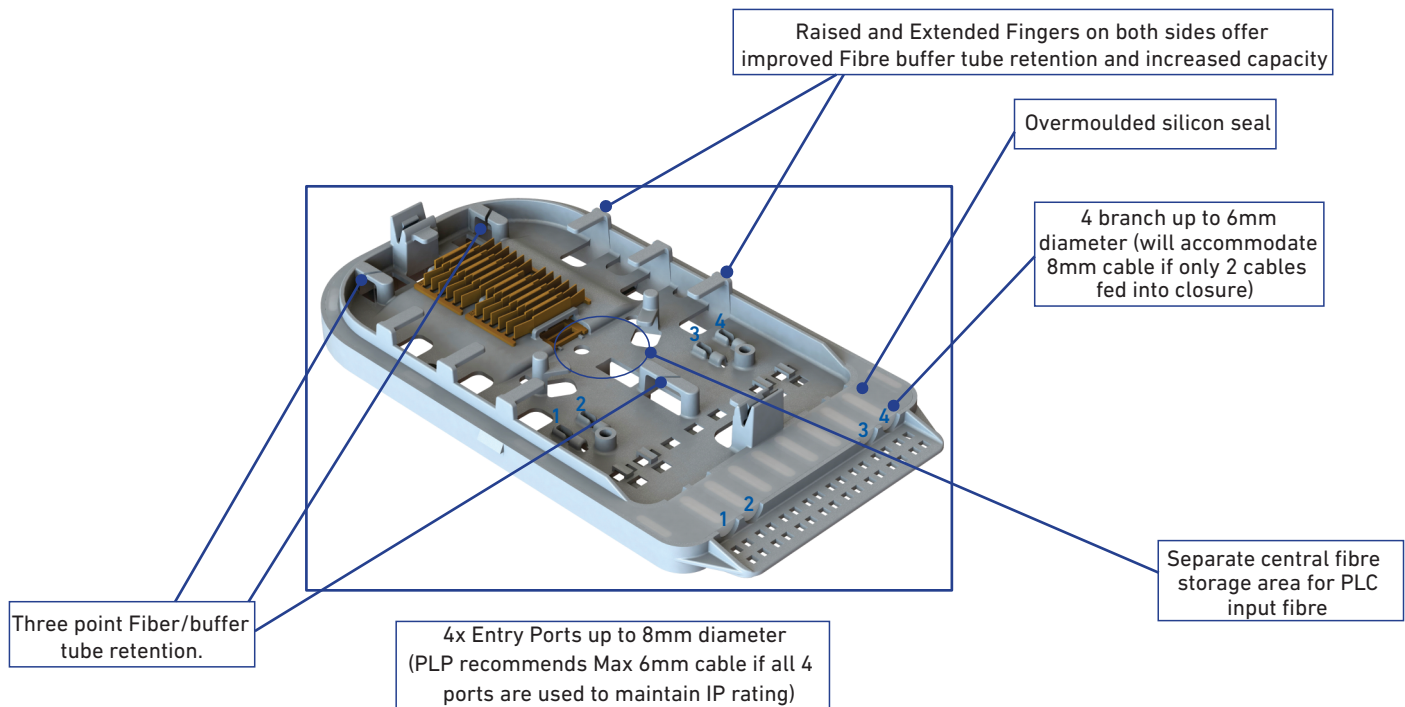

# COYOTE®MDC-V2

## Feeder/Splice side-No trays: 24F Configuration-Max 24F

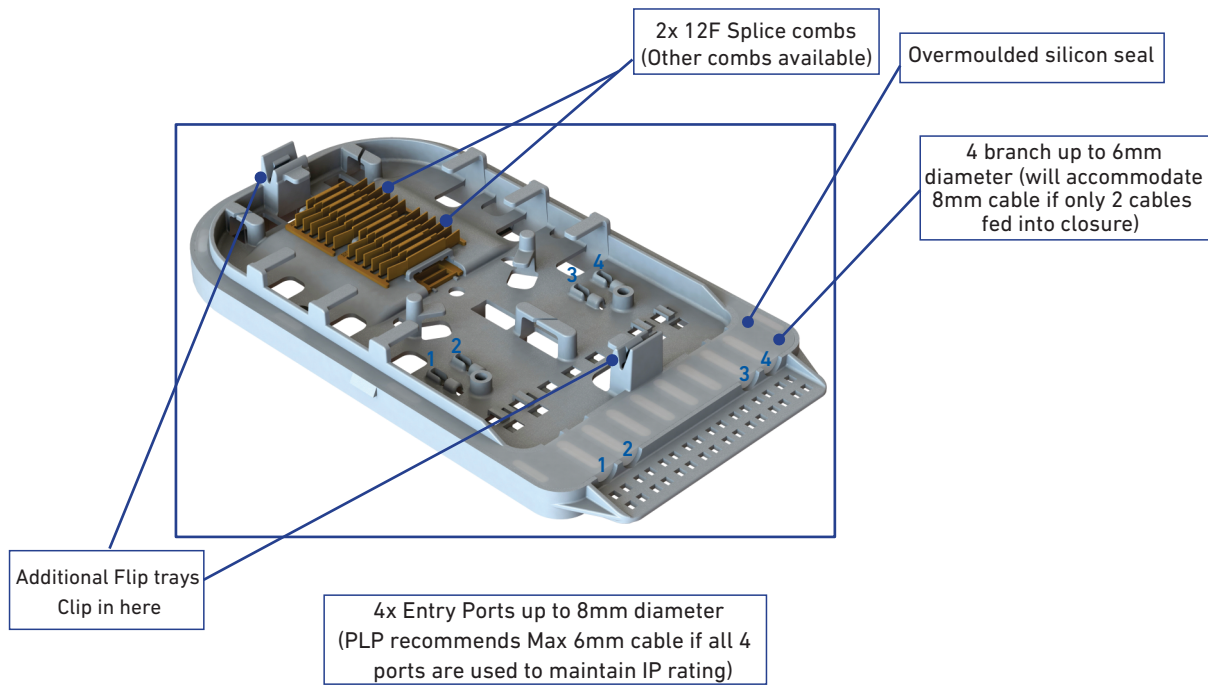

NOTE: While this will accommodate 24F on this side, an addition 24F can still be spliced on the opposite side of the fibre management tray.

## Feeder/Splice side: Trays Open -36F Capacity Configuration.

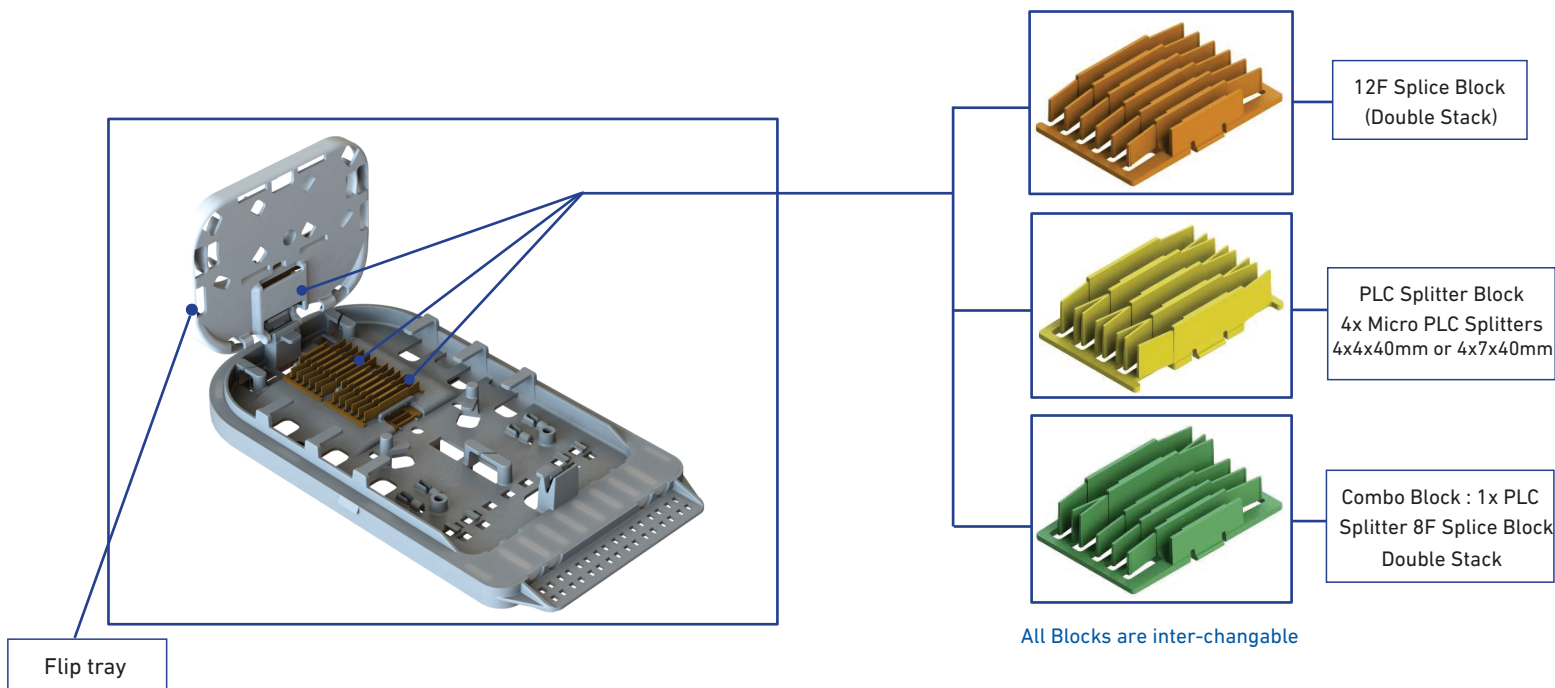



# COYOTE®MDC-V2

## Feeder/Splice side: Trays Open -48F Capacity Configuration.

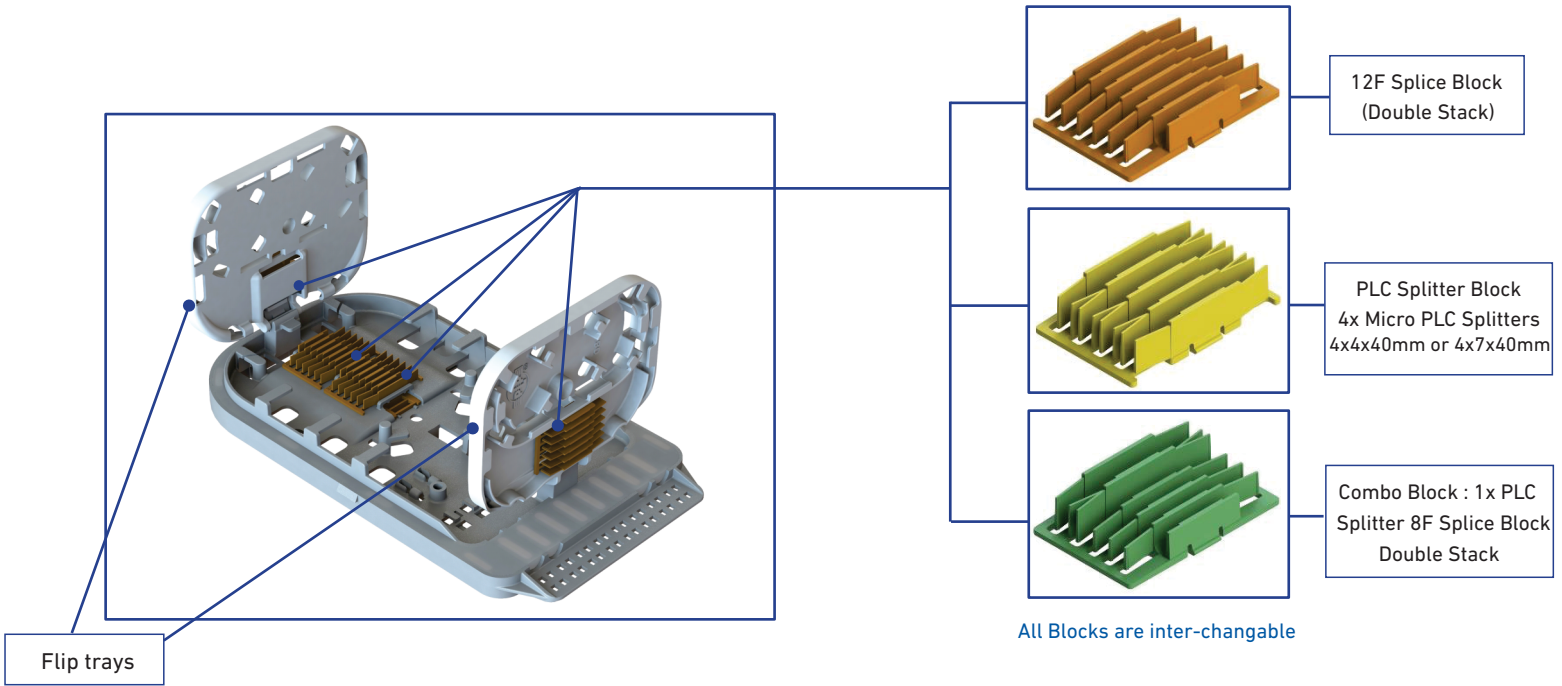

NOTE: While this will accommodate 48F on this side, an addition 24F can still be spliced on the opposite side of the fibre management tray.

## Drop Side Pre-connectorized Configuration

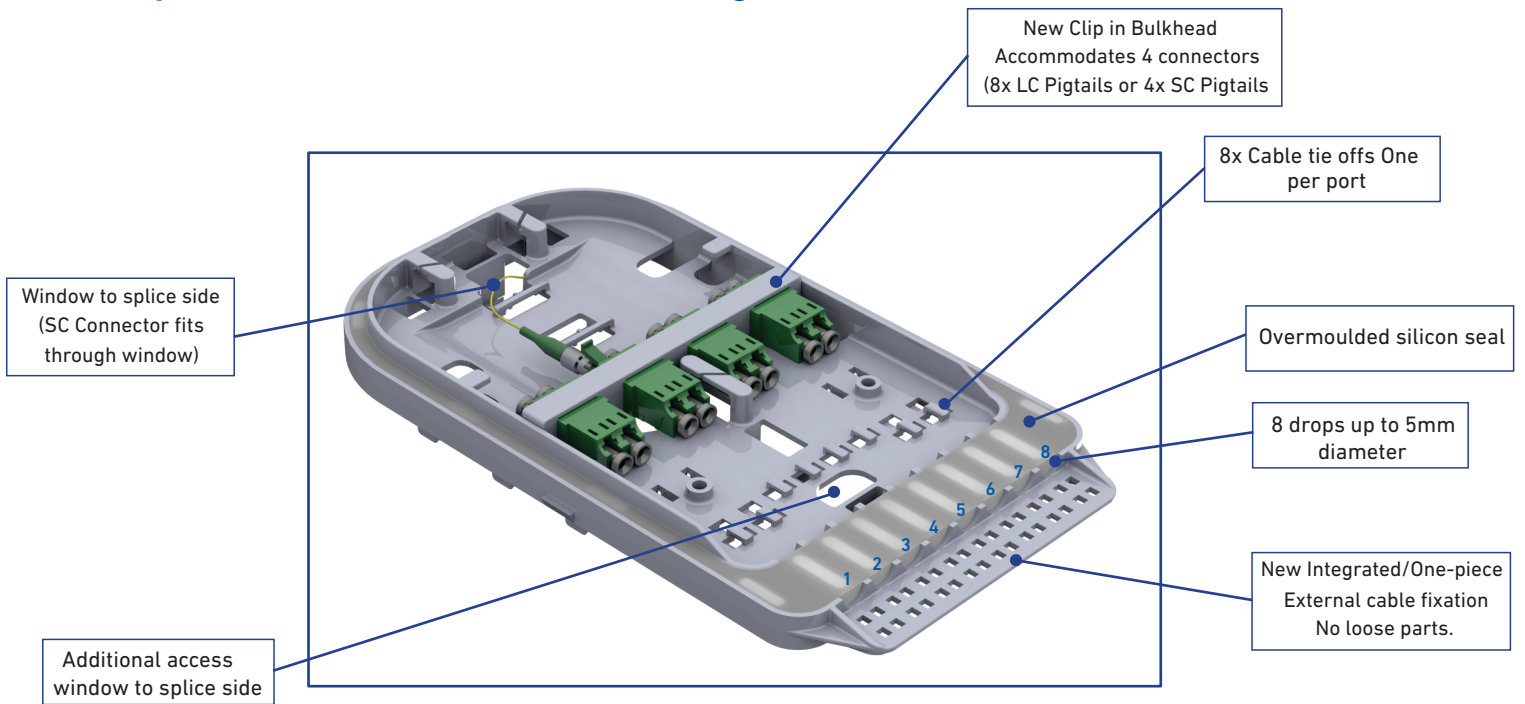

# COYOTE®MDC-V2

## Drop Side - Splice Configuration

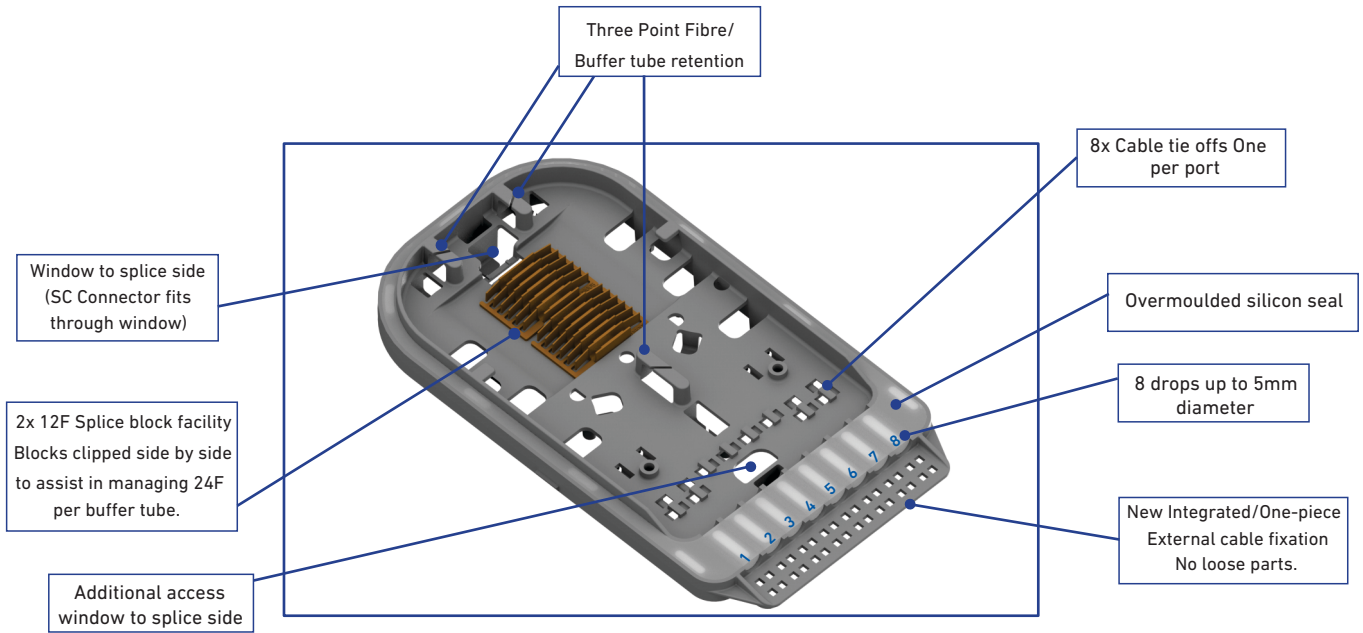

## COYOTE®MDC-V2: Accessory Options









# COYOTE® MDC-V2: Configurator

Catalog Number Example: MDC-V2-48-4-0-1-0-0

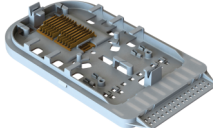
MDC-V2- XX - X - X - X - X - X  
 (Section 1) (Section 2)\* (Section 3)\* (Section 4)\* (Section 5)\* (Section 6)\*

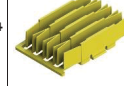
\*Insert Zero "0" in Sections 2 to 6 if item is not required.

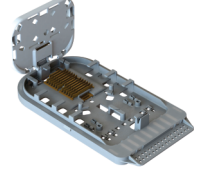
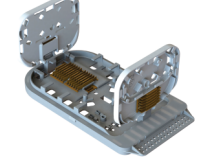
MDC-V2	Section 1	Section 2	Section 3	Section 4	Section 5	Section 6	
	48 Incl. Bulkhead (Excl. Mid-Couplers)  	QTY Number of splice blocks 1-4  <b>12F SPLICE</b> 12F Splice Protectors (Double Stack)	QTY Number of splitter blocks 1-4  <b>SPLITTER</b> 4 x Micro PLC Splitters • 4 x 4 x 40mm or • 4 x 7 x 40mm	QTY Number of combo blocks 1-4  <b>COMBO</b> 1 x Micro PLC Splitter + 8F Splice Protectors (Double Stacked)	QTY  1-4 1 x Micro PLC Splitter (10mm High) + 12F Splice Protectors (Triple Stacked)	1: Splice Protectors to match the number of 12F blocks selected ( 12/24/36/48/60/72) 2: Pole/Wall Mount Tee-Bracket  <b>ACCESSORIES</b> <small>*Bulk head, Foam tape, cable ties and screws included as standard items in every kit.</small>	
	60 	72 				<small>*Not Suitable for use on white Flip Trays</small>	







PLP SOUTH AFRICA  
180 OHRTMANN ROAD  
WILLOWTON, PIETERMARITZBURG  
3201

(033) 397 5800  
SALES@PLP.COM  
PLP.COM

© 2024 Preformed Line Products