



# COYOTE® Terminal Dome Closure 6.5" x 17"

Be sure to read and completely understand this procedure before applying product.  
Be sure to select the proper PREFORMED™ product before application.













### NOMENCLATURE

- |   |   |   |
|---|---|---|
| 1. Dome Cover (1)   | 4. Dome Collar (1)  | 10. Pigtail Kit (1)                         |
| 2. Organizer Assembly with Hardened Adapter End Plate (1) | 5. Dome Gasket (1)  | 11. Grommet (2)                             |
| 3. LITE-GRIP® Short Splice Tray (1)                       | 6. Short Strength Member Bracket (2)                                      | 12. Hose Clamp (4)                          |
|   | 7. Nut (4)  | 13. Silicone Lubricant (1 five gram packet) |
|   | 8. Lock Washer (4)  |   |
|   | 9. Transition Tube Kit (3) – Only in Kits for Unitube/Ribbon Applications |   |

COYOTE Terminal 6.5" x 17" Dome Closure Kits	
Catalog Number	Description
COYTD617B0-000	<b>COYOTE Terminal Dome Closure for Buffer Tube Applications with 0 Hardened Adapters (all Plugs).</b> Includes: (2) Grommets, (1) Organizer Assembly with End Plate with all plugs, (1) Collar Assembly, (1) Gasket, (1) Small Parts Bag, & (1) LITE-GRIP® Splice Tray
COYTD617R0-000	<b>COYOTE Terminal Dome Closure for Unitube/Ribbon Applications with 0 Hardened Adapters (all Plugs).</b> Includes: (2) Grommets, (1) Organizer Assembly with End Plate with all plugs, (1) Collar Assembly, (1) Gasket, (1) Small Parts Bag, (3) Transition Tube Kits, & (1) LITE-GRIP® Splice Tray
COYTD617B1-000	<b>COYOTE Terminal Dome Closure for Buffer Tube Applications with 1 Hardened Adapter.</b> Includes: (2) Grommets, (1) Organizer Assembly with End Plate with 1 Hardened Adapter, (1) Collar Assembly, (1) Gasket, (1) Small Parts Bag, (1) Pigtail Kit, & (1) LITE-GRIP® Splice Tray
COYTD617R1-000	<b>COYOTE Terminal Dome Closure for Unitube/Ribbon Applications with 1 Hardened Adapter.</b> Includes: (2) Grommets, (1) Organizer Assembly with End Plate with 1 Hardened Adapter, (1) Collar Assembly, (1) Gasket, (1) Small Parts Bag, (3) Transition Tube Kits, (1) Pigtail Kit, & (1) LITE-GRIP® Splice Tray
COYTD617B2-000	<b>COYOTE Terminal Dome Closure for Buffer Tube Applications with 2 Hardened Adapters.</b> Includes: (2) Grommets, (1) Organizer Assembly with End Plate with 2 Hardened Adapters, (1) Collar Assembly, (1) Gasket, (1) Small Parts Bag, (1) Pigtail Kit, & (1) LITE-GRIP® Splice Tray
COYTD617R2-000	<b>COYOTE Terminal Dome Closure for Unitube/Ribbon Applications with 2 Hardened Adapters.</b> Includes: (2) Grommets, (1) Organizer Assembly with End Plate with 2 Hardened Adapters, (1) Collar Assembly, (1) Gasket, (1) Small Parts Bag, (3) Transition Tube Kits, (1) Pigtail Kit, & (1) LITE-GRIP® Splice Tray
COYTD617B3-000	<b>COYOTE Terminal Dome Closure for Buffer Tube Applications with 3 Hardened Adapters.</b> Includes: (2) Grommets, (1) Organizer Assembly with End Plate with 3 Hardened Adapters, (1) Collar Assembly, (1) Gasket, (1) Small Parts Bag, (1) Pigtail Kit, & (1) LITE-GRIP® Splice Tray
COYTD617R3-000	<b>COYOTE Terminal Dome Closure for Unitube/Ribbon Applications with 3 Hardened Adapters.</b> Includes: (2) Grommets, (1) Organizer Assembly with End Plate with 3 Hardened Adapters, (1) Collar Assembly, (1) Gasket, (1) Small Parts Bag, (3) Transition Tube Kits, (1) Pigtail Kit, & (1) LITE-GRIP® Splice Tray
COYTD617B4-000	<b>COYOTE Terminal Dome Closure for Buffer Tube Applications with 4 Hardened Adapters.</b> Includes: (2) Grommets, (1) Organizer Assembly with End Plate with 4 Hardened Adapters, (1) Collar Assembly, (1) Gasket, (1) Small Parts Bag, (1) Pigtail Kit, & (1) LITE-GRIP® Splice Tray
COYTD617R4-000	<b>COYOTE Terminal Dome Closure for Unitube/Ribbon Applications with 4 Hardened Adapters.</b> Includes: (2) Grommets, (1) Organizer Assembly with End Plate with 4 Hardened Adapters, (1) Collar Assembly, (1) Gasket, (1) Small Parts Bag, (3) Transition Tube Kits, (1) Pigtail Kit, & (1) LITE-GRIP® Splice Tray

Accessory Kits	
80808456	COYOTE® Dome End Plate Fixture
8003715	Hardened Adapter Kit with Installation Tool
8003724	Plug Kit with Installation Tool
80807972	Adapter Installation Tool
Mounting Brackets	
8003831	Aerial Hanger Bracket (Dome Mount) for Strand Mount Applications
8003833	Aerial Hanger Bracket Kit (For ADSS)
8003851	Aerial Hanger Bracket with Offset Brackets (Dome Mount) for Strand Mount Applications
8003702	Pole/Wall Mounting Bracket
8003835	Universal Mounting Bracket Kit for Hand Holes

Splice Tray/Closure Capacities for 6.5" x 17" COYOTE® Dome Closures				
Splice Tray	Catalog Number	Splice Type	Trays per Closure	Closure Splice Capacity
Low Profile LITE-GRIP® (24 ct.)	80809958	Single Fusion	6	144
Deep Profile LITE-GRIP® (40 ct.)	80808945	Single Fusion	3	120
Deep Profile LITE-GRIP® (144 ct.)	LGSTR144	Mass Fusion/ Ribbon	3	432

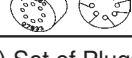
COYOTE® Grommet Chart			
For use in COYOTE® GLC, Aerial, LCC, Dome, In-Line RUNT, Taut & Terminal Closures			
PLP Catalog Number	Cable Range Inches (mm)	Description	Splitting Location
8003691	.40 - .60 (10.2 - 15 mm)	1-entry grommet	
8003692	.60 - .85 (15 - 22 mm)	1-entry grommet	
8003693	.85 - 1.0 (22 - 25 mm)	1-entry grommet	
8003694	1.0 - 1.25 (25 - 32 mm)	1-entry grommet	
8003663	.42 - .60 (11 - 15 mm)	2-entry grommet	
8003664	.30 - .43 (8 - 11mm)	4-entry grommet	
8004065	.250 - .312 (6.4 - 7.9 mm)	4-entry grommet	
8003990	.50 - .60 (12.7 - 15.2) .125 - .25 (3.2 - 6.4) and flat drop	4-entry grommet	
8003665	.125 - .25 (3 - 6 mm)	6-entry grommet	
8003676	.42 - .60 (11 - 15 mm) .125 - .25 (3 - 6 mm)	7-entry grommet	
8003677	.125 - .25 (3 - 6 mm)	8-entry grommet	

**NOTE:** Grommet Kit contains (1) Grommet, (1) Cable Measure Tape, (2) Silicone Lubricant Packs, (1) Set of Plugs & (1) Glove

## End Plate Preparation

**Step #1** Measure cable to determine diameter and hole location to use in grommet.



**Step #2a** If using cut cable, insert cable through grommet. If your application requires express/balloon/ring cut cables, **see Step 3 for grommet slitting procedure.**

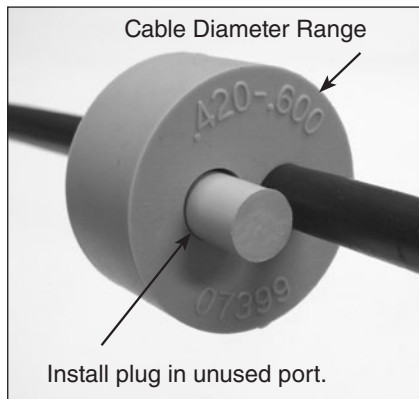

**Step #2b** **Installing Figure 8 Style Cables and Cables with Tracer Wires** - Remove tracer wire or ground wire from the portion of the cable that will be positioned in the grommet and insert cable into grommet.

### Cable with Tracer Wire



Not Correct Installation



Correct Installation

### Figure 8 Style Cable

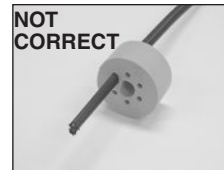

Not Correct Installation

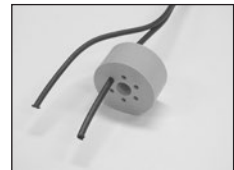

Correct Installation

**Step #3** **Grommet Slitting** – If slitting is required, lay grommet on a stable flat surface. Position utility knife with the cutting edge against the top surface and cut through grommet. **Consult grommet chart on page 2 for slitting locations of all grommets.**

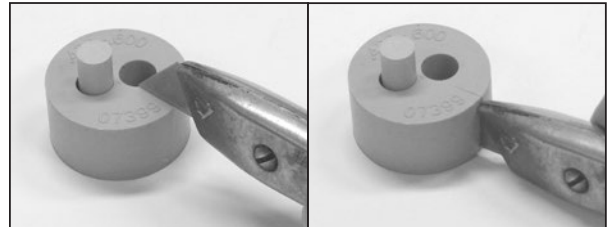

**PLP Tip:** Use a pen to sketch slitting lines on top surface of grommet prior to cutting.

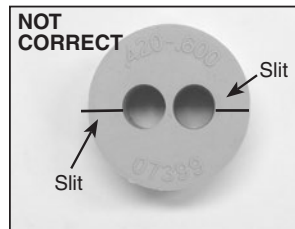

Not Correct Slitting Angle

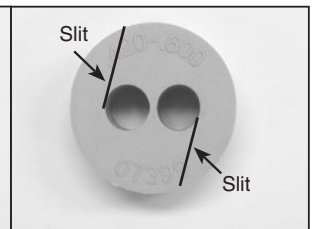

Correct Slitting Angle

**Step #4** Prepare loose tube/buffer tube or unitube/  
ribbon cable(s) for cut applications.

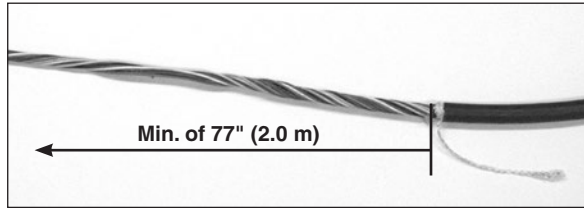

**Minimum Sheath Opening for Cut Cable Applications**

77"	2.0 m
-----	-------

**PLP Tip:** Leave about 8" (203 mm) of strength member to trim later.

**Cable Sheath Opening for Applications Where Fiber is Dedicated to the Splice Point**

**Step #5a** Prepare loose tube/buffer tube or unitube/  
ribbon cable(s) for mid sheath applications  
(Express/Balloon/Ring Cut).

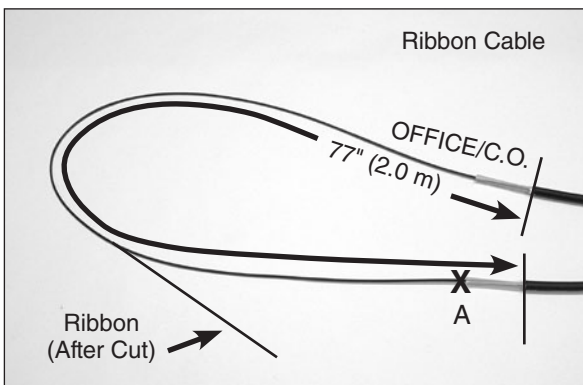
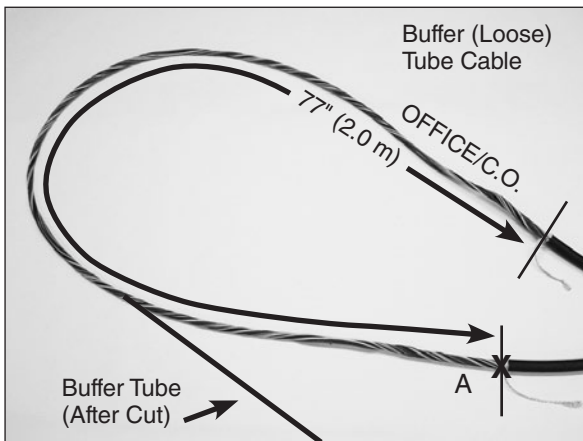

**NOTE:** When expressing ribbons in the transition tray of the closure at this measurement, the maximum number of ribbons that can be expressed is 24 ribbons (288 fibers).

**For Applications Where Fiber is Dedicated to the Splice Point**

Sheath Opening	Min. of 77" (2.0 m)
Fiber/Buffer Tube Cut Location	A (see image above)

**PLP Tip:** Leave about 8" (203 mm) of strength member to trim later.

**Cable Sheath Opening for Applications Where Fiber is NOT Dedicated to the Splice Point**

**Step #5b** Prepare loose tube/buffer tube or unitube/  
ribbon cable(s) for mid sheath applications  
(Express/Balloon/Ring Cut).

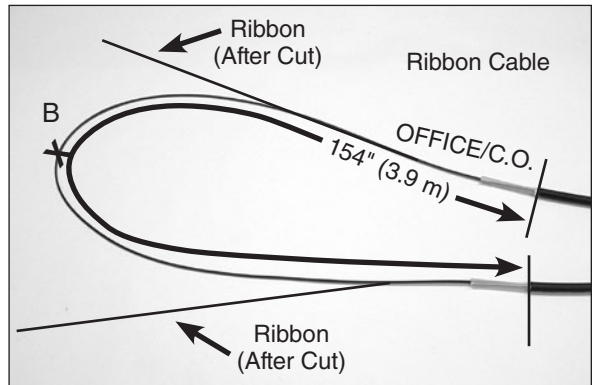
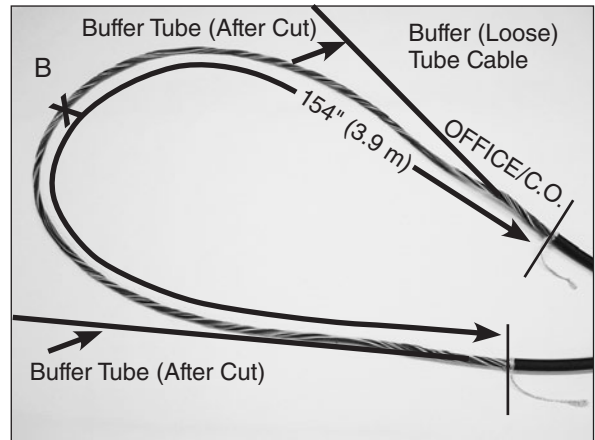

**NOTE:** When expressing ribbons in the transition tray of the closure at this measurement, the maximum number of ribbons that can be expressed is 12 ribbons (144 fibers).

**For Applications Where Fiber is NOT Dedicated to the Splice Point**

Sheath Opening	Max. of 154" (3.9 m)
Fiber/Buffer Tube Cut Location	B (see image above)

**PLP Tip:** Leave about 8" (203 mm) of strength member to trim later.

**Cable Sheath Opening for Applications Where Fiber is Expressed through the Buffer Tube**

**Step #5c** Prepare loose tube/buffer tube cable(s) for expressed fiber (buffer tube window cut).

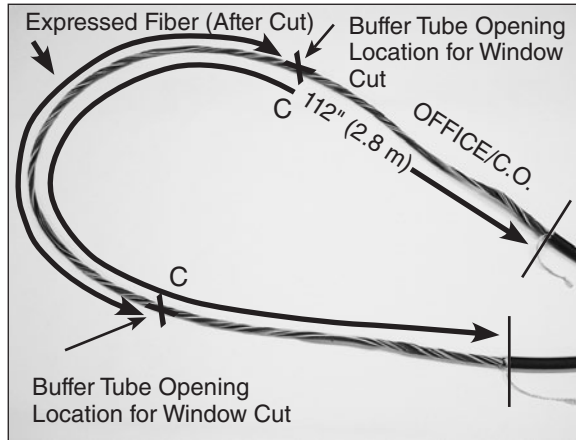

For Applications Where Fiber is Expressed through the Buffer Tube	
Sheath Opening	112" (2.8 m)
Buffer Tube Opening Location	C (see image above)

**PLP Tip:** Leave about 8" (203 mm) of strength member to trim later.

**Step #6** Prepare Central/Buffer Tube(s) for Unitube/Ribbon Cable Applications.

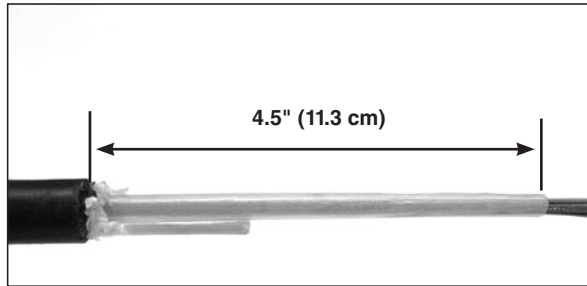

**Step #7** If the cable contains Kevlar®, braid roughly 3" (7.2 cm) of the Kevlar.

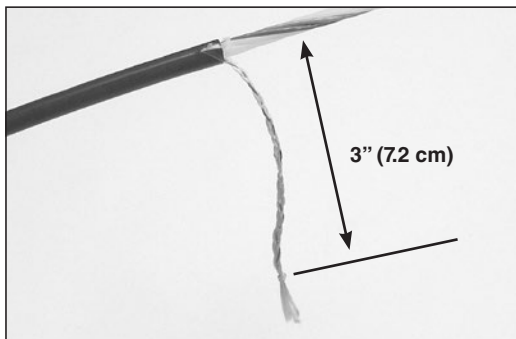

Kevlar® is a registered trademark of DuPont.

**Step #8a** Align sheath opening with end of slot of the strength member bracket as shown.

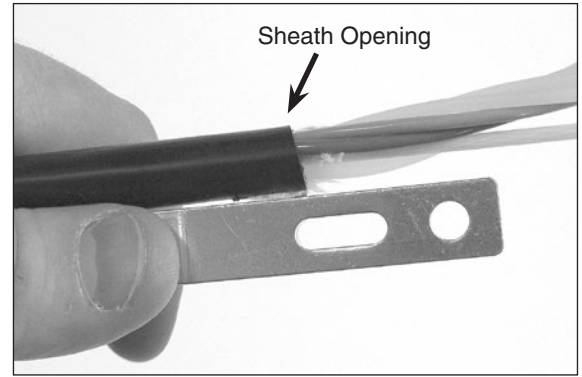

**Step #8b** Trim strength member(s) flush with end of the strength member bracket(s).

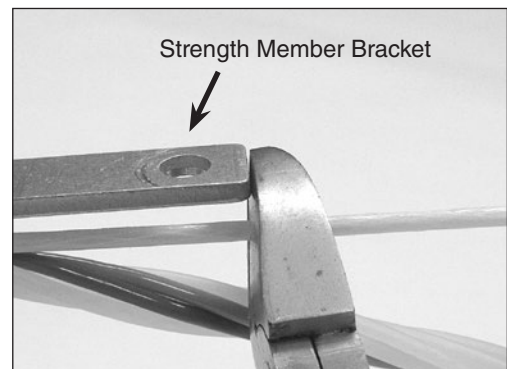

**Step #9** Install cap on strength member bracket.

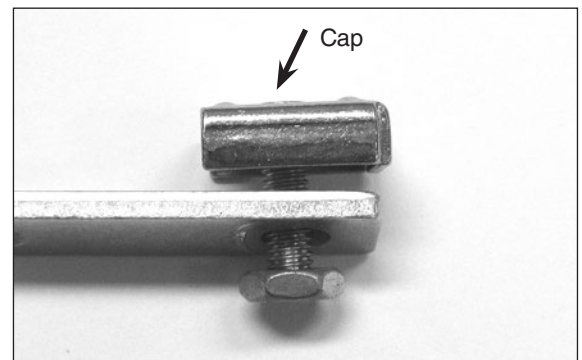

**Step #10** Position strength member(s) under cap of strength member bracket.

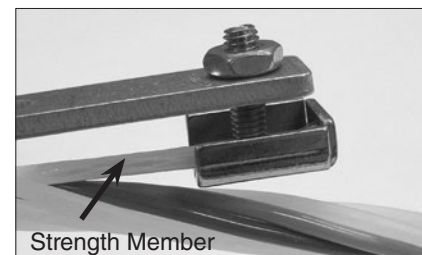

**Step #11** If the cable contains Kevlar®, wrap the braided Kevlar around the stud of the cap as shown.

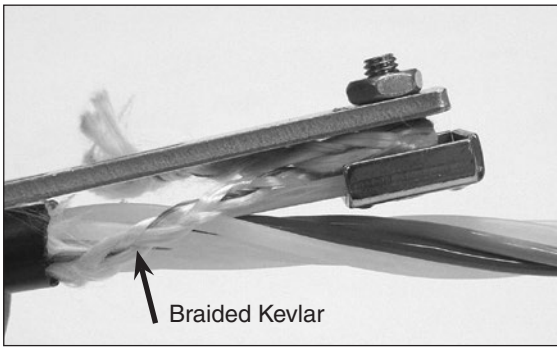

**Step #12** Tighten nut of cap to secure strength member and braid under the cap.

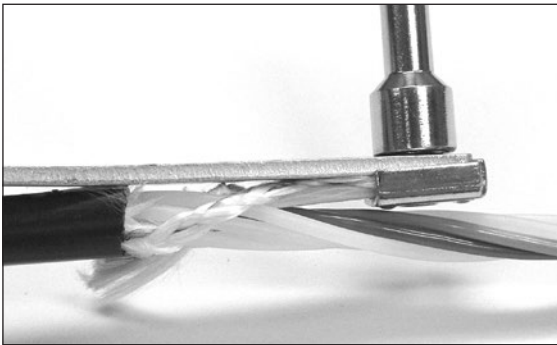

**Step #13** Secure cable to strength member bracket with hose clamp.

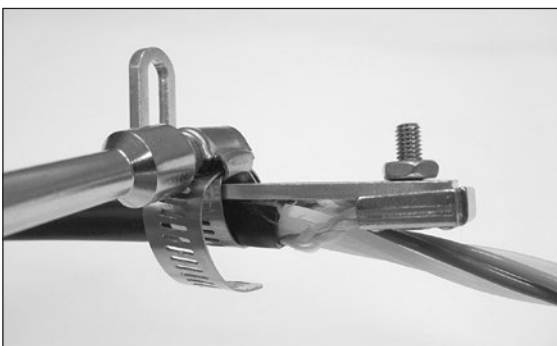

## Attaching Shielded Cable to Strength Member Bracket

**Step #14a** For shielded cable applications, PLP recommends using a 3M 4460-D/FO Fiber Optic Shield Connector (PLP PN: 80803989), install shield connector on cable and insert stud of shield connector through slot of strength member bracket.

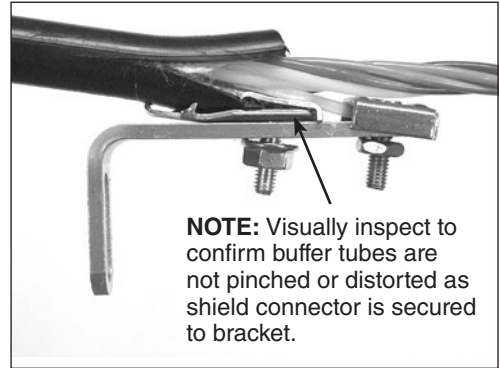

Follow standard company practices when applying shield connector to cable.

**Step #14b** Secure shield connector to strength member bracket with nut and secure cable strength member under cap of the strength member bracket.

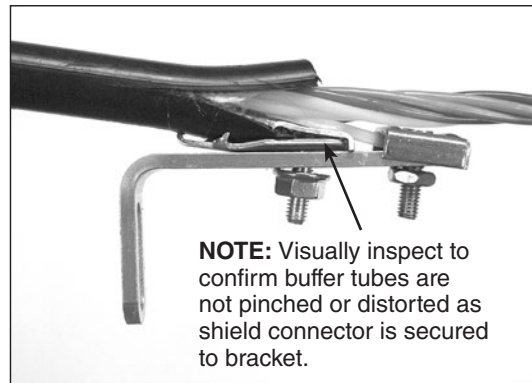

**Step #14c** Secure shielded cable to strength member bracket with hose clamp.

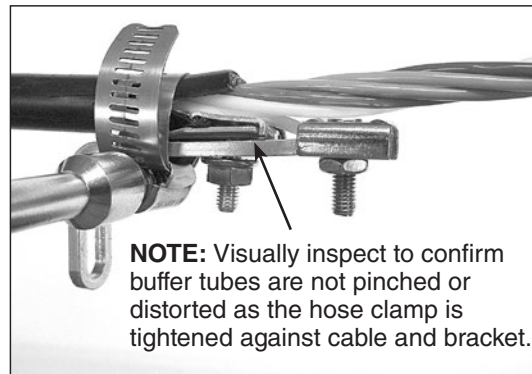

**Step #15a** Lubricate the outer surface of the grommet.

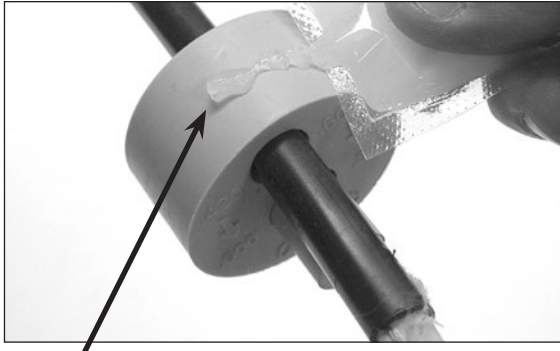

Lubricate sealing surface of grommet with silicone lubricant provided.

**Step #16b** Secure strength member bracket on stud with lock washer and nut.

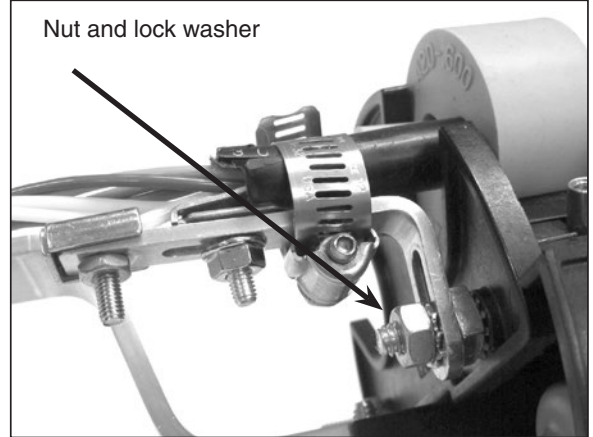

**Step #15b** Position grommet in end plate slot.

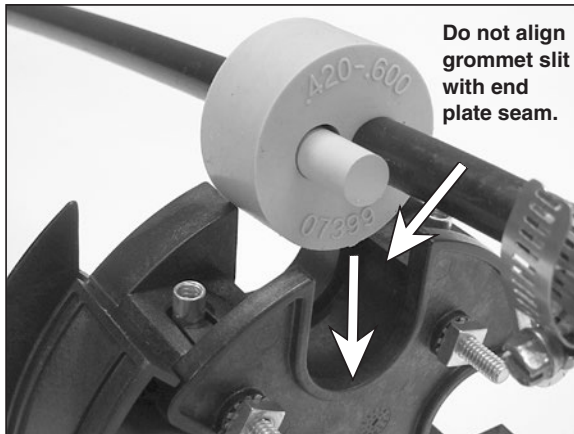

**Step #17** Install cable cap and secure with hex bolts.



**NOTE:** Tighten bolts by hand evenly until cable cap is fully seated (DO NOT USE POWER TOOLS TO TIGHTEN BOLTS).

**NOTE:** TIGHTEN ALL UNUSED CABLE CAPS.

**Step #16a** Position slot of strength member bracket leg over stud and pull back cable.

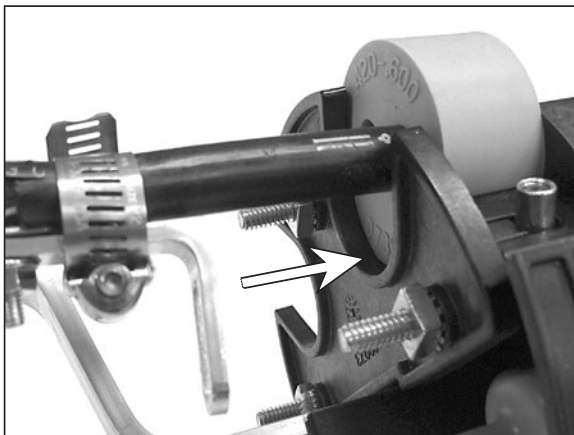

**Step #18** Complete end plate assembly.



## Buffer Tube Applications

**Step #19** Route and store buffer tubes in storage brackets.

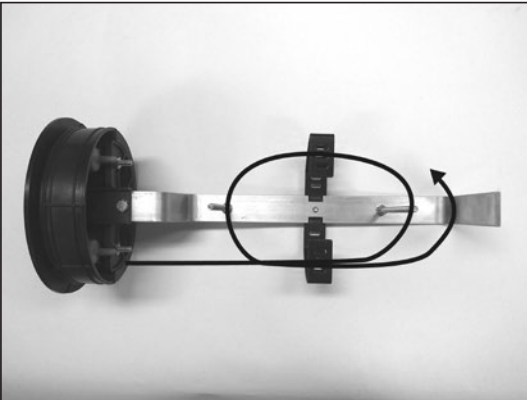
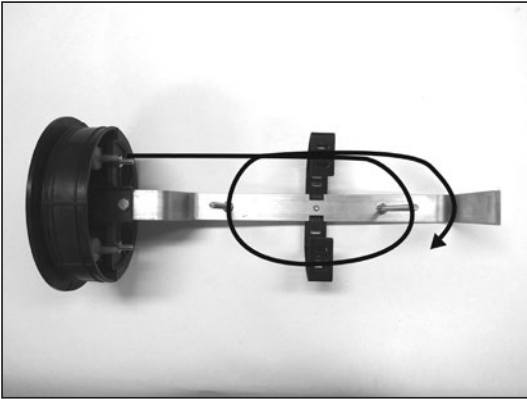

**Step #20** Route buffer tube(s) to splice tray(s) and secure.

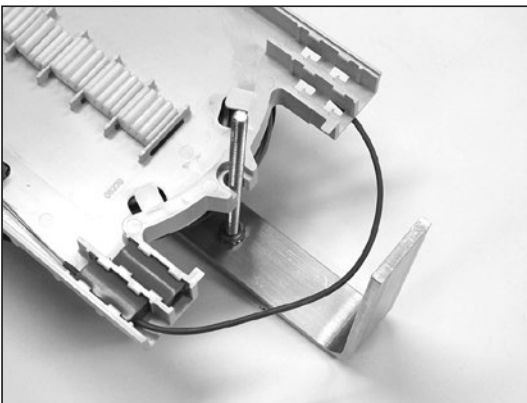

## Unitube Applications

**Step #21** Route and secure central tube of Unitube cables to transition tray and secure with tie wraps.

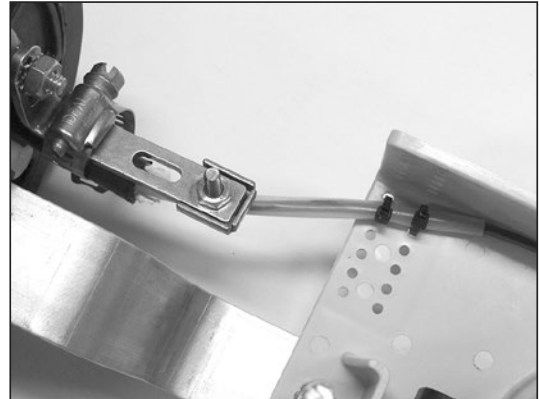

**Step #22** Route feeder fibers or ribbons within transition tray.

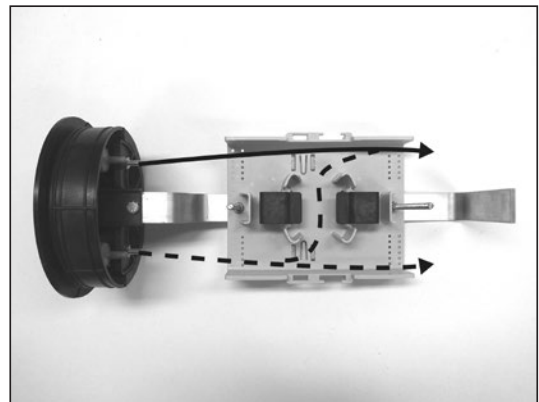

**Step #23** Route expressed fibers or ribbons under organizer clips.

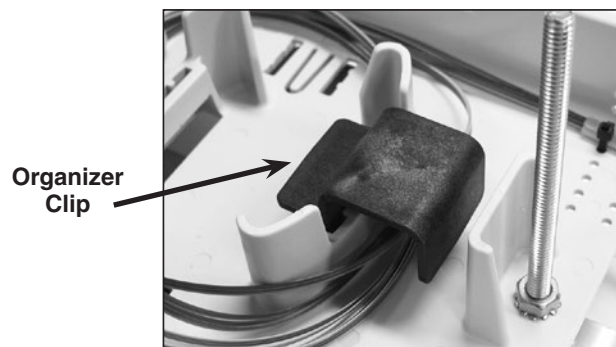



**Step #24** Insert fibers or ribbons to be routed to splice tray(s) into transport tube(s) and secure tubes to transition tray with tie wraps.

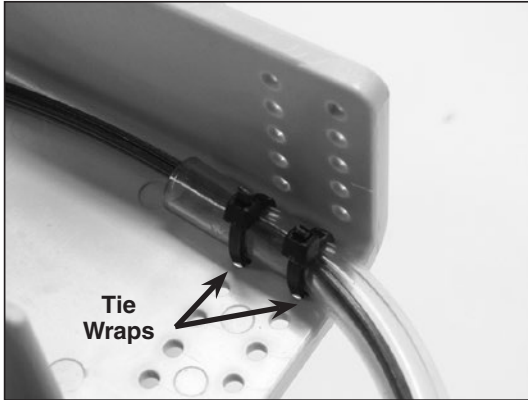

**Step #25** Install cover on transition tray.

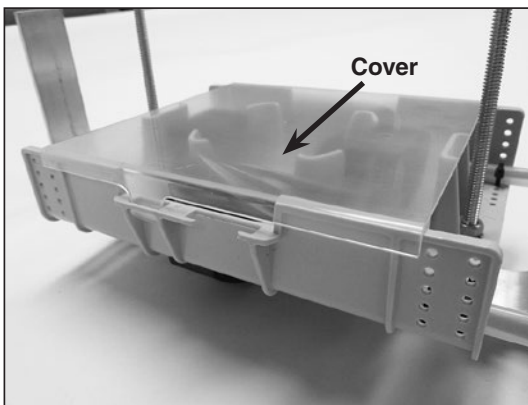

**Step #26** Route transport tube(s) to splice tray(s) and secure.

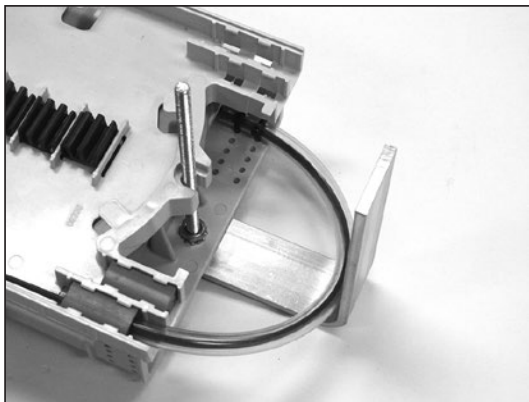

## Pigtail Assembly Installation

**Step #27** Measure and mark pigtail. Remove the pigtail jacket and Kevlar® beyond this mark.

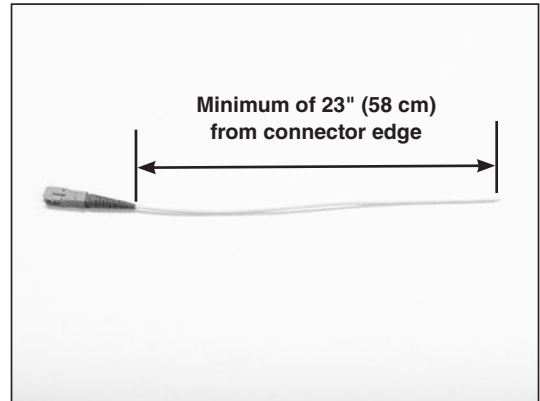

**Step #28** Install pigtails into LITE-GRIP® Sleeve.

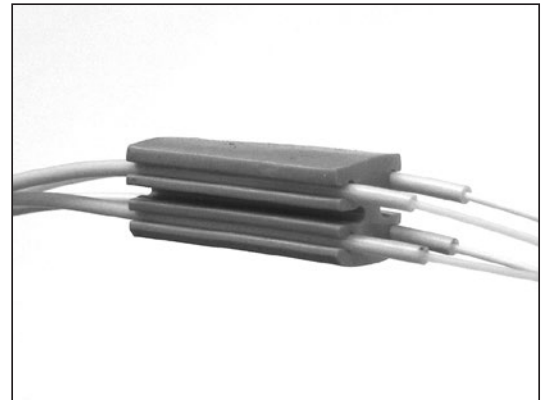

**Step #29** Install LITE-GRIP® Sleeve with pigtails into splice tray.



## Splice Tray Management

**Step #30** Route incoming fibers in splice tray.

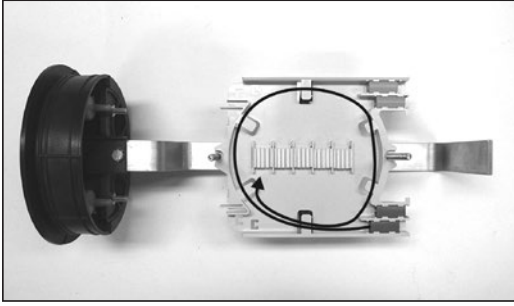

**Step #31** Route outgoing pigtail fibers in splice tray.

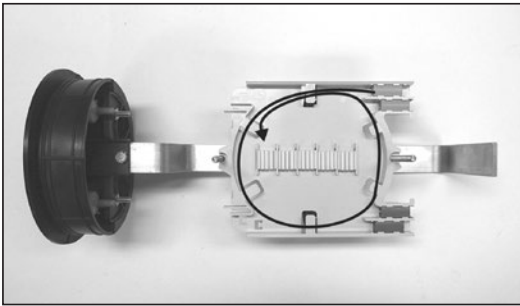

**Step #32** Splice incoming fibers to outgoing pigtail fibers per your accepted company practices.

**Step #33** Secure splice tray(s) with hold down strap.

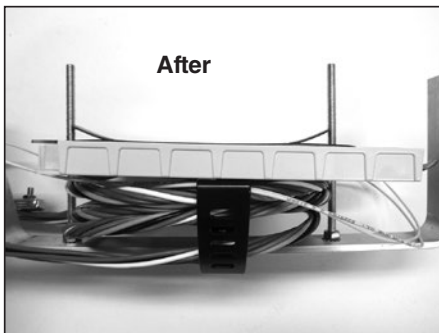
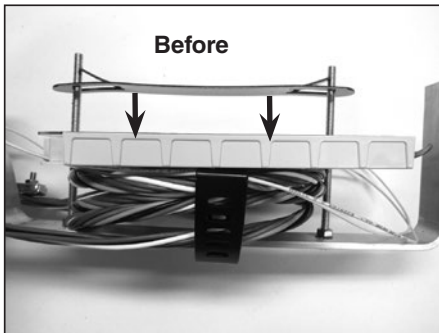

## Pigtail Routing

**Step #34** Route pigtails to end plate as shown.

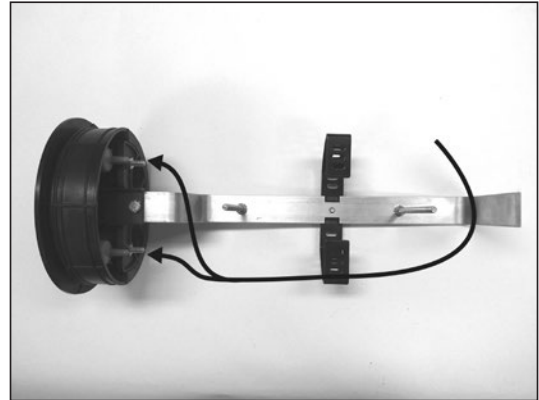

**Step #35** Install pigtail connectors into adapters.

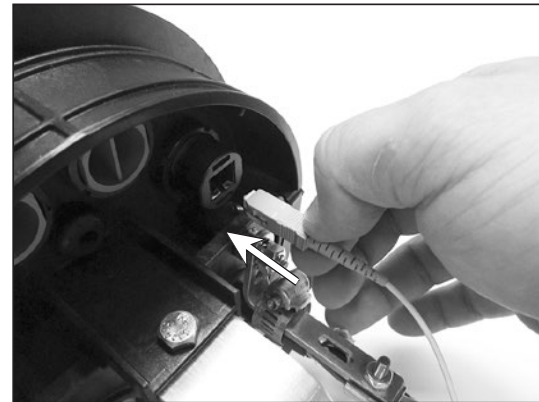

## Dome & Collar Installation

**Step #36** Lubricate all surfaces around gasket with silicone lubricant to assure easy assembly and closure re-entry.

**Lubricate all inner surfaces of the gasket.**

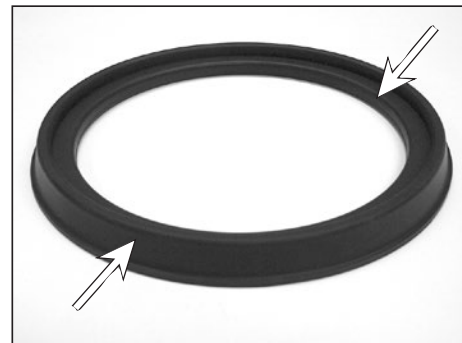

**Lubricate all outer surfaces of the gasket.**

**Step #37** Slide end plate gasket onto end plate and press into groove.

**Make sure gasket is fully seated in groove of end plate.**

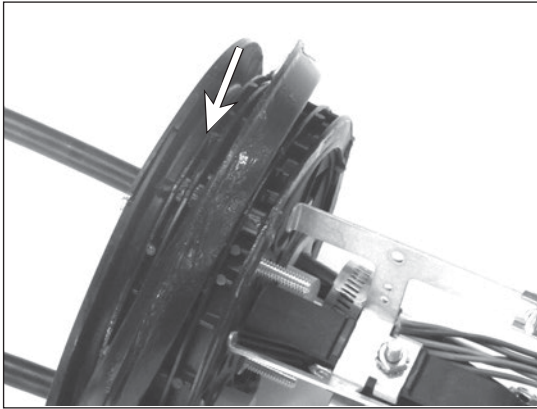

**Step #38** Re-tighten all cable cap bolts (step #17) to assure that the cable caps are fully seated. When using a can wrench or nut driver, the installed torque is 35 to 40 in-lbs.

**Step #39** Work the gasket into the groove.

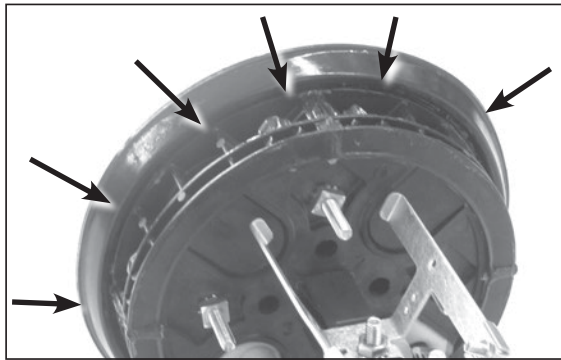

**Step #40** Position the dome over end plate.

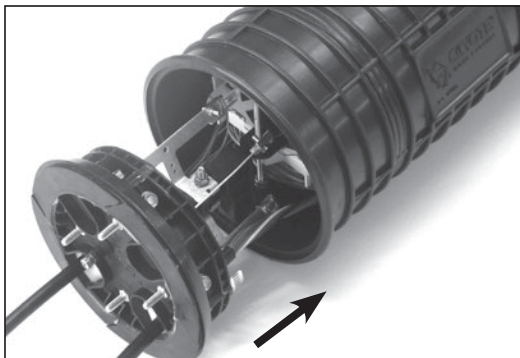

**Step #41** Position the collar flat on the work surface in front of the closure as shown below.

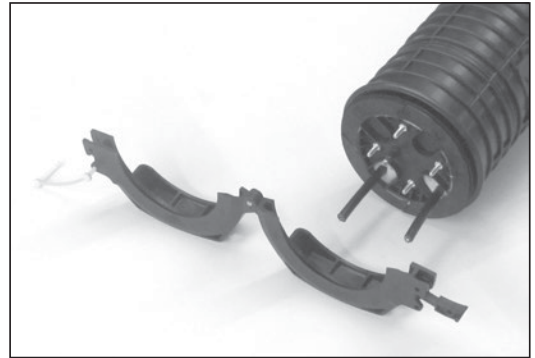

**Step #42** While holding the collar in place, compress a portion of the end plate into the dome and insert them in the groove of the collar near the latch, as shown below.

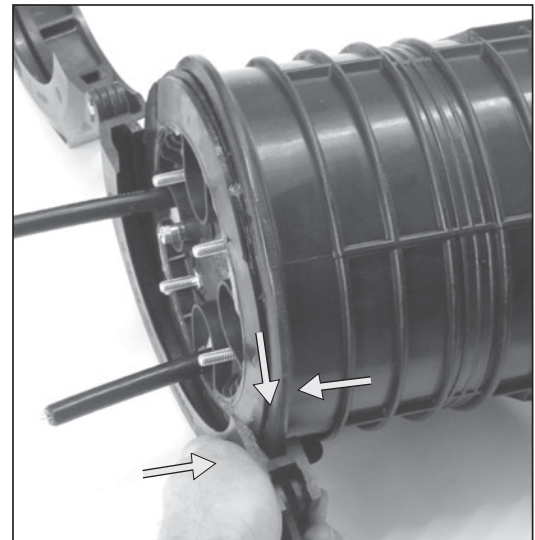

**Step #43** While holding the collar in place, push against the end of the dome and slightly lift and push the other half of the dome up and over the lip of the collar with your fingers to fully install the dome in the collar half.

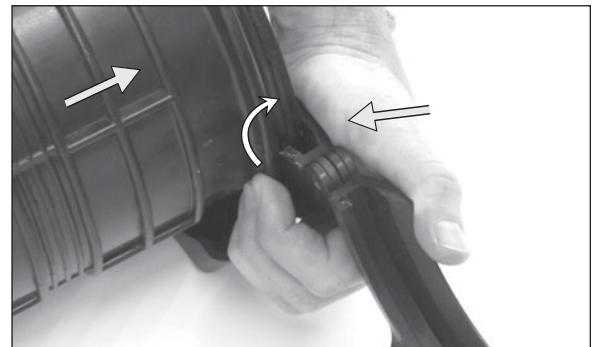

**Step #44** Check to make sure the lip of the dome is captured within the collar half

**Front Side**

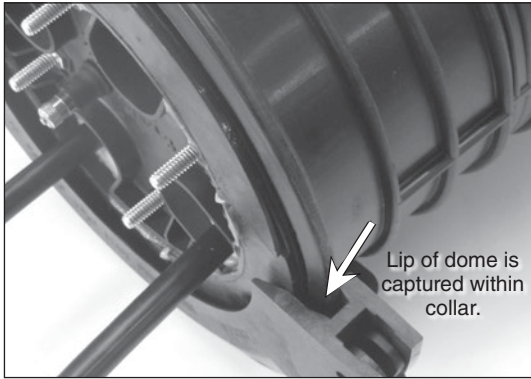

**Back Side**

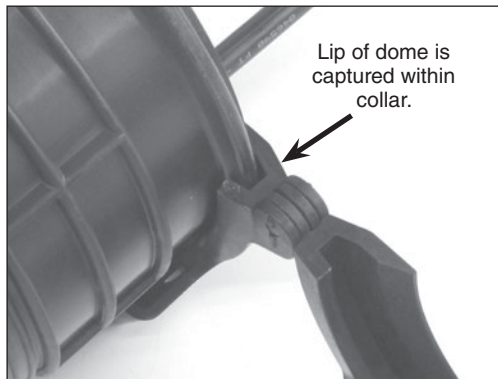

**Step #45** Install the other collar half onto the closure.

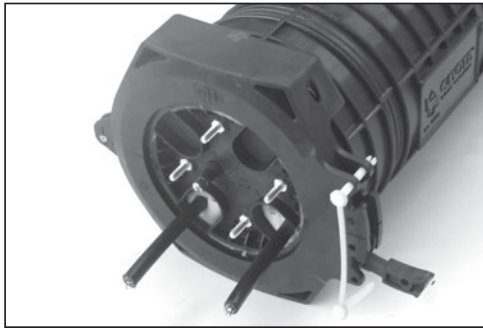

**Step #46** Secure the collar with the latch and pin.

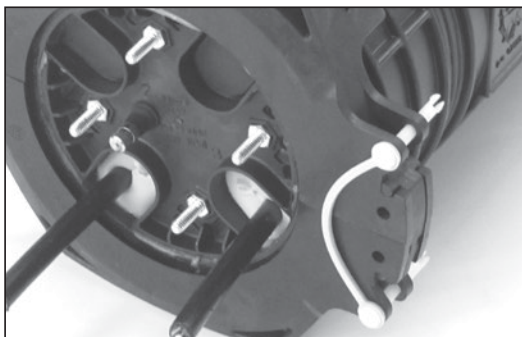

## Flash Test Procedure

**Step #47** Remove cap from air valve of end plate.



**Step #48** Pressurize closure up to a max of 10psi.

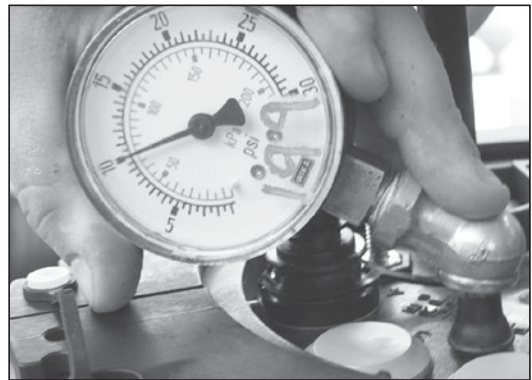

**Step #49a** Spray all sealing surfaces of the dome end plate with soapy water to determine if there are any leaks.



**Step #49b** Make sure to spray and check for leaks around the O-Rings of the hardened adapters and plugs.

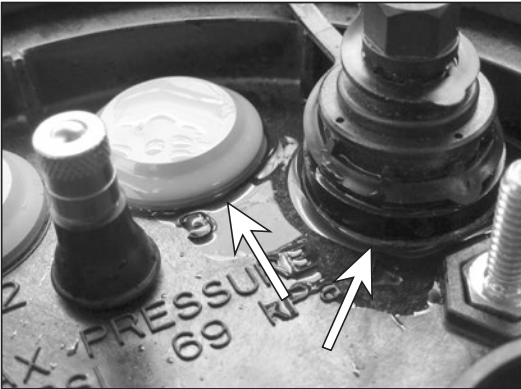

O-Rings

**Step #50** Release the pressure in the closure using the bump on the top of the air valve cap.

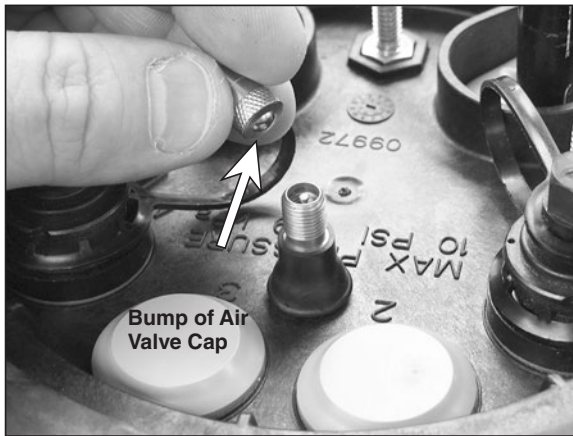

Bump of Air Valve Cap

## Common End Plate Leaks During Flash Testing

Leak occurring at the corner of the cable port due to the cap of the cable port not being fully tightened.



Leak occurring at the corner of the cable port

Leak occurring at the cable entry of the grommet due to the cable not being within the stated cable diameter range of the grommet.

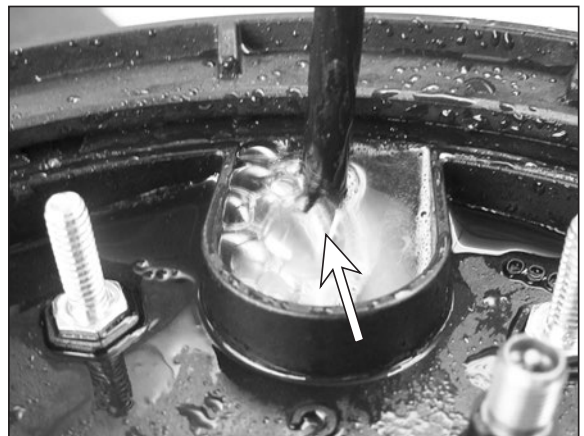

Leak occurring at the cable entry of the grommet

## Aerial Mounting Options

**Step #51a For 6.5" Dome Strand Mount Aerial Offset Bracket Kit (P/N: 8004035) and 6.5" Dome ADSS Mount Aerial Offset Bracket Kit (P/N: 8004036).**

Assemble each bug nut or ADSS clamp to each top aerial offset bracket as shown below.

**Strand Clamp**

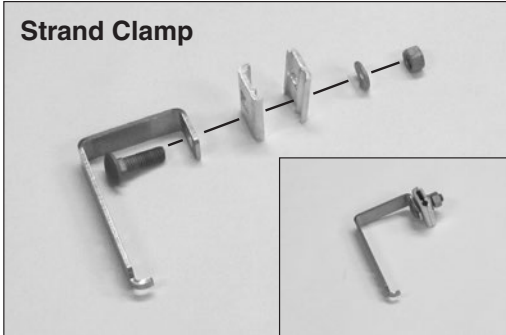

**ADSS Clamp**

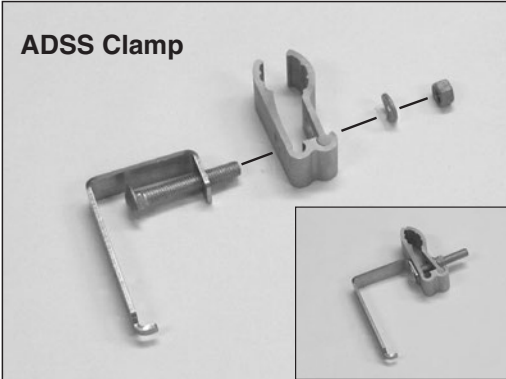

**Step #51b For 6.5" Dome Strand Mount Aerial Offset Bracket Kit (P/N: 8004035) and 6.5" Dome ADSS Mount Aerial Offset Bracket Kit (P/N: 8004036).**

**For Shorter Spacing.** Align the top aerial offset bracket with the bottom aerial offset bracket in either Position 1 or Position 2 as shown below. Secure the top aerial offset bracket to the bottom aerial offset bracket with the bolts and keps nuts provided.

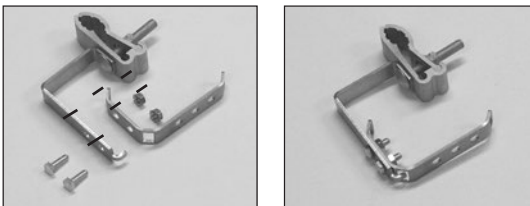

**Position 1 – ADSS Clamp Shown**

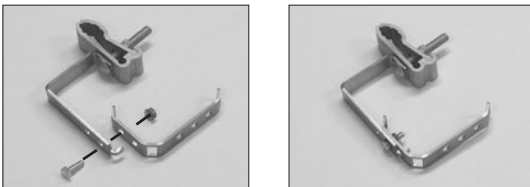

**Position 2 – ADSS Clamp Shown**

**Step #51c For 6.5" Dome Strand Mount Aerial Offset Bracket Kit (P/N: 8004035) and 6.5" Dome ADSS Mount Aerial Offset Bracket Kit (P/N: 8004036).**

**For Taller Spacing.** Align the top aerial offset bracket with the bottom aerial offset bracket in either Position 1 or Position 2 as shown below. Secure the top aerial offset bracket to the bottom aerial offset bracket with the bolts and keps nuts provided.



**Position 1 – Strand Clamp Shown**



**Position 2 – Strand Clamp Shown**



**Step #52 6.5" Dome Strand Mount Aerial Offset Bracket Kit (P/N: 8004035) and 6.5" Dome ADSS Mount Aerial Offset Bracket Kit (P/N: 8004036).** Insert hose clamp through slots in each of the bottom aerial offset brackets.

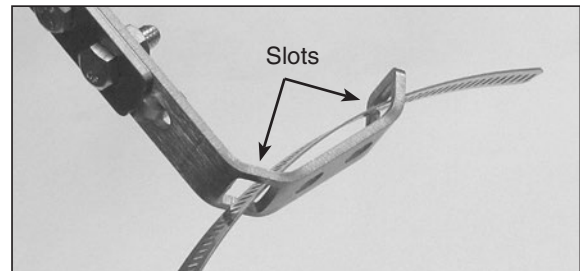

**Step #53 6.5" Dome Strand Mount Aerial Offset Bracket Kit (P/N: 8004035) and 6.5" Dome ADSS Mount Aerial Offset Bracket Kit (P/N: 8004036).** Tighten each hose clamp around the dome.



**Step #54** 6.5" Dome Strand Mount Aerial Offset Bracket Kit (P/N: 8004035) and 6.5" Dome ADSS Mount Aerial Offset Bracket Kit (P/N: 8004036).  
Bracket installed on dome closure.



**Step #57** COYOTE Universal Mounting Bracket for Hand Hole Applications (P/N: 8003835).

Position the brackets in the banding channels of the dome. Tighten the banding until the brackets are secure.



### Hand Hole Mounting Option

**Step #55** COYOTE Universal Mounting Bracket for Hand Hole Applications (P/N: 8003835).  
Secure the Universal Mounting Bracket to the inner wall of the hand hole using 2 screws.

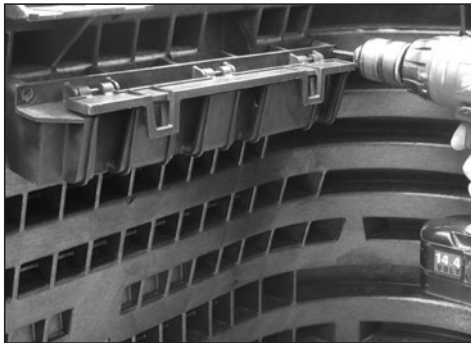

**Step #58** COYOTE Universal Mounting Bracket for Hand Hole Applications (P/N: 8003835).

Slide the hanger brackets into the proper slots of the Universal Mounting Bracket and snap the hinged lid into place to secure the hanger brackets.

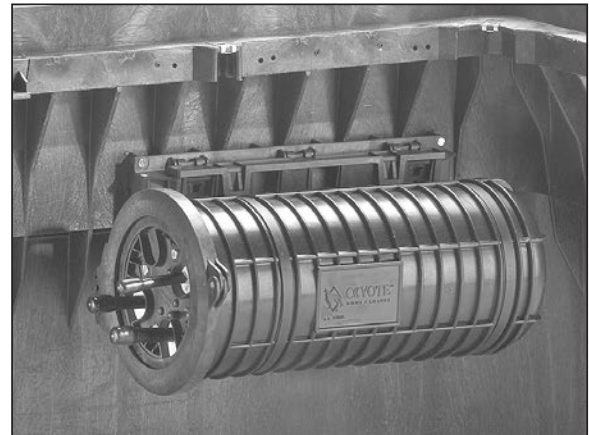

**Step #56** COYOTE Universal Mounting Bracket for Hand Hole Applications (P/N: 8003835).

Insert banding (plastic or metal) through the slots of the hanger brackets.

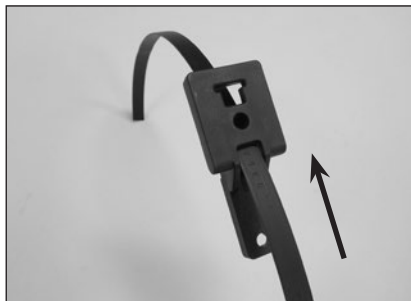

## Pole/Wall Mounting Option

### Step #59 The 6.5" COYOTE Dome Pole/Wall Mount Bracket (P/N: 8003702).

Position the bolts through the stud mount plate as shown, and install lock nuts on bolts until there is a 1/8" (3 mm) gap between the nut and the stud mount plate.

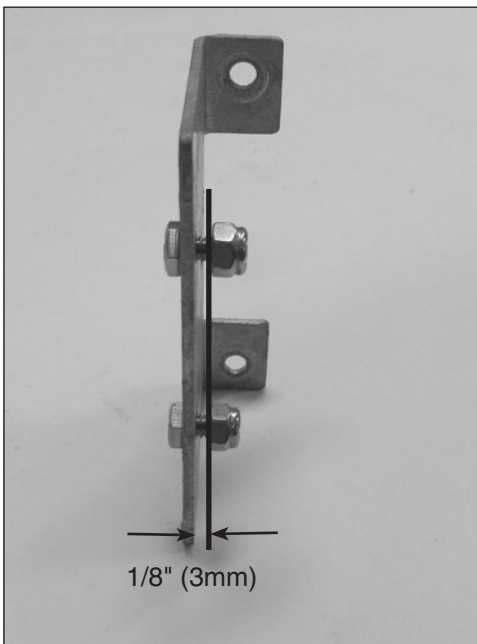
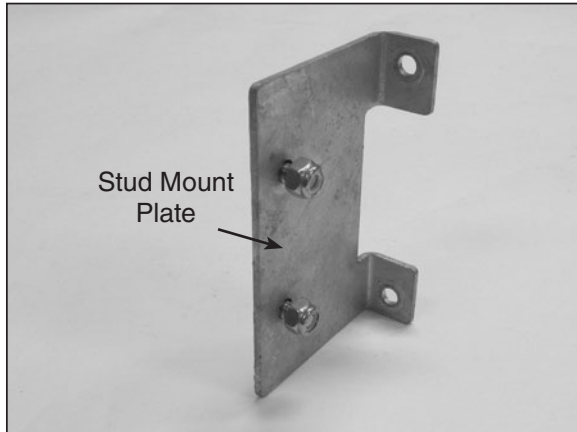

### Step #60 The 6.5" COYOTE Dome Pole/Wall Mount Bracket (P/N: 8003702).

Slide the bolts of stud mount plate into the slots of the pole/wall mount bracket as shown and tighten the lock nuts until the plates are secure.

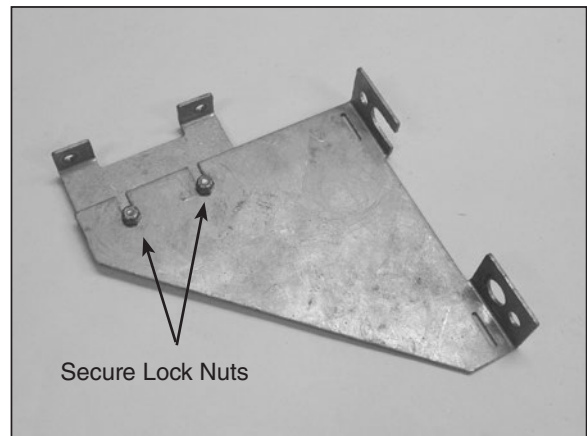
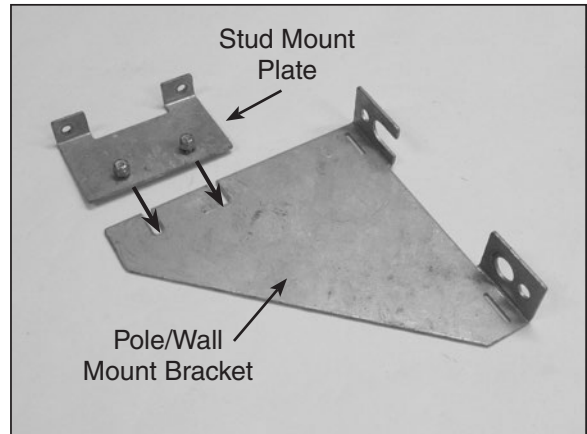



**Step #61 The 6.5" COYOTE Dome Pole/Wall Mount Bracket (P/N: 8003702).**

Attach the dome pole/wall mount bracket to a pole or wall with either 5/8" through bolts, 1/4" lag screws, or banding straps.

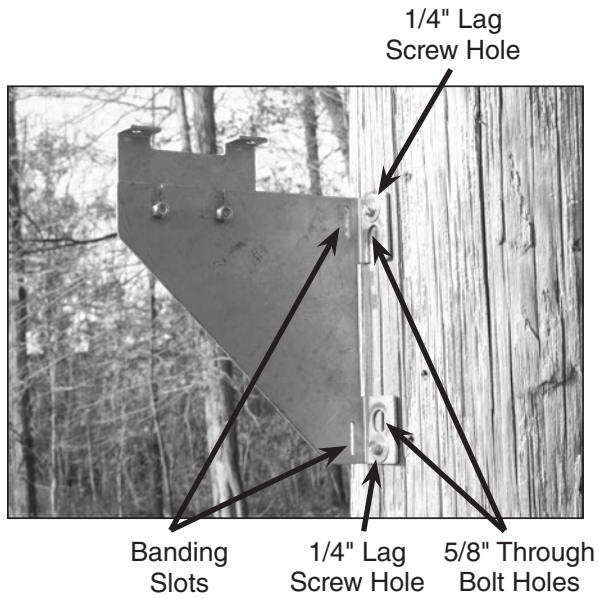

**Step #62 The 6.5" COYOTE Dome Pole/Wall Mount Bracket (P/N: 8003702).**

Attach the COYOTE Dome closure to the pole/wall mount bracket by inserting the studs of the dome closure end plate through the stud holes of the stud mount plate and securing with the lock nuts provided.

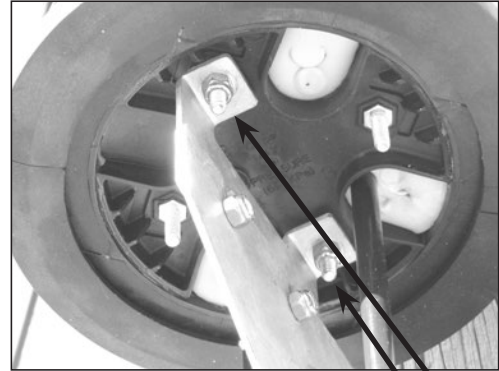

Secure Lock Nuts

## Mounting Options

**Step #63a Dome Aerial Mounting Bracket – Dome Mount – for 6.5" x 17" or 6.5" x 22" Dome Closures.**

The COYOTE® Dome Mount Aerial Bracket Kit (Cat. No. 8003831) can be used to suspend the COYOTE® Dome Closure from the messenger wire. To install the dome, mount aerial brackets, position the brackets in the banding channels of the dome and insert banding (plastic or metal) through the slots of the brackets. Tighten the banding until the brackets are secure before mounting the closure to the messenger wire with the bug nuts of the brackets.

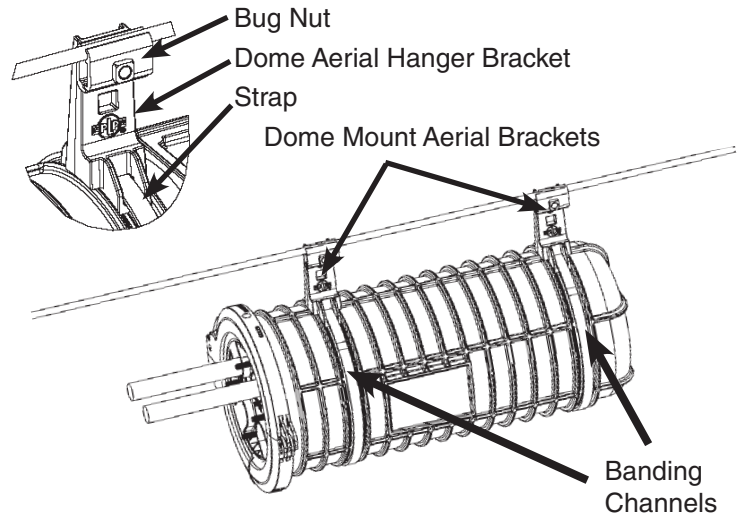

**Step #63b 6.5" x 17" or 6.5" x 22" Dome Mount Aerial Bracket – Dome Mount – for ADSS.**

The COYOTE® Dome Mount Aerial Bracket Kit for ADSS (Cat. No. 8003833) can be used to suspend the 6.5" x 17" or 6.5" x 22" COYOTE® Dome Closure from ADSS cable. To install the dome, mount aerial brackets, position the brackets in the banding channels of the dome and insert banding (plastic or metal) through the slots of the brackets. Tighten the banding until the brackets are secure before mounting the closure to the ADSS cable dead-end with the ADSS clamp.

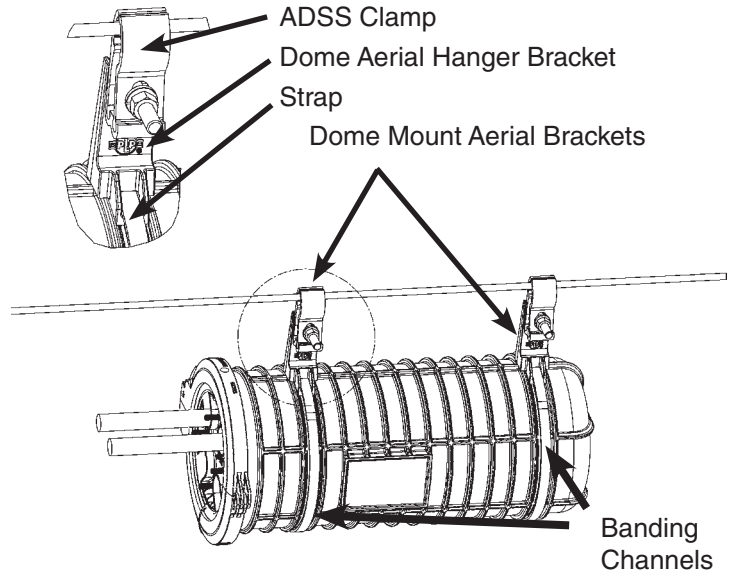

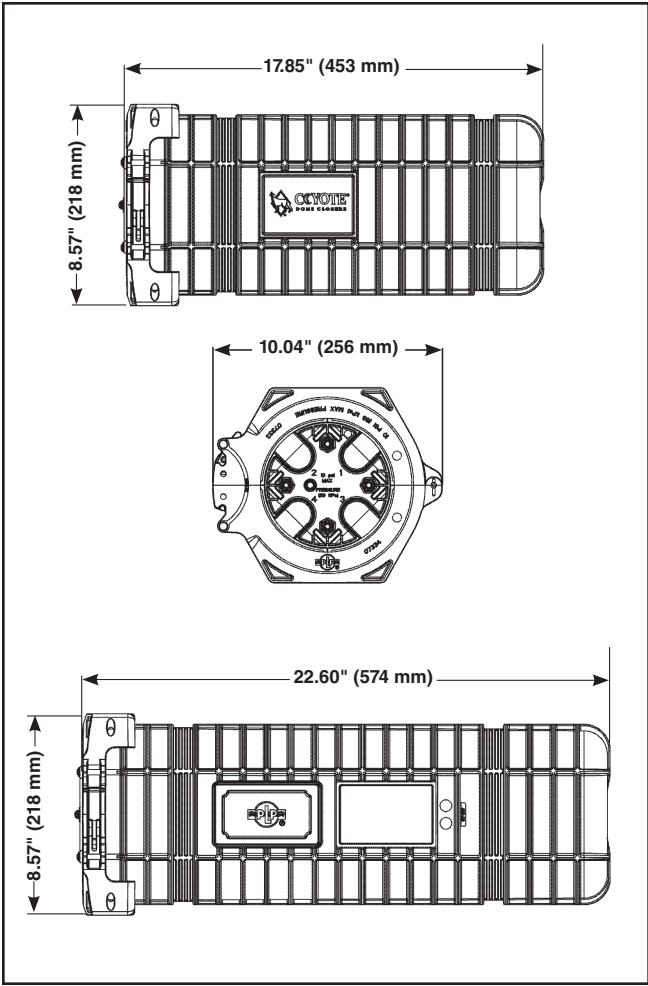

## SAFETY CONSIDERATIONS

This application procedure is not intended to supersede any company construction or safety standards. This procedure is offered only to illustrate safe application for the individual. **FAILURE TO FOLLOW THESE PROCEDURES MAY RESULT IN PERSONAL INJURY OR DEATH.**

**Do not modify this product under any circumstances.**

This product is intended for use by trained technicians only. **This product should not be used by anyone who is not familiar with, and not trained to use it.**

When working in the area of energized lines, extra care should be taken to prevent accidental electrical contact.

For proper performance and personal safety, be sure to select the proper size PREFORMED™ product before application.

PREFORMED products are precision devices. To insure proper performance, they should be stored in cartons under cover and handled carefully.



# PREFORMED LINE PRODUCTS

P.O. Box 91129, Cleveland, Ohio 44101 • 440.461.5200 • [www.preformed.com](http://www.preformed.com) • e-mail: [inquiries@preformed.com](mailto:inquiries@preformed.com)

SP3115-3