

THERMOLIGN® Suspension

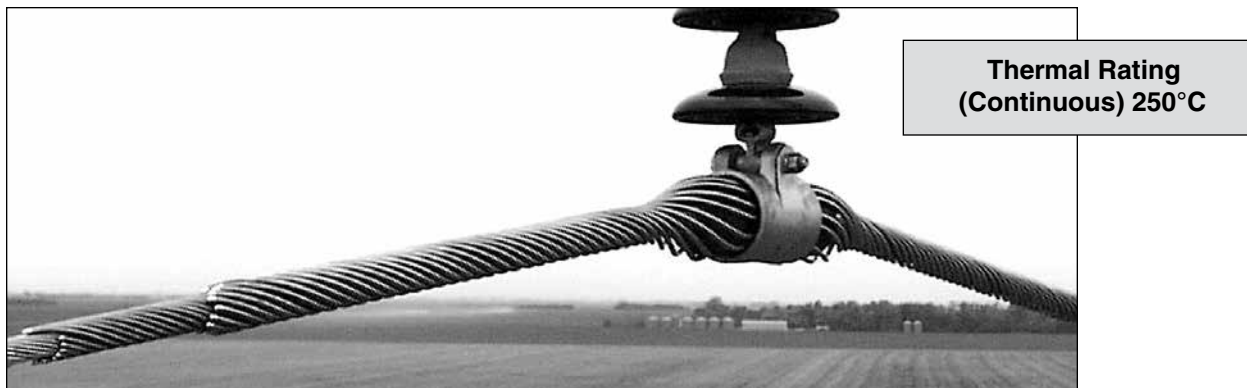

GENERAL RECOMMENDATIONS

The THERMOLIGN Suspension is specifically designed for applications on aluminum based high temperature conductors that will be operated at continuous temperatures **ABOVE** 200°C, and features:

- Multi-layer design for maximum mechanical performance and maximum heat dissipation.
- Minimal heat transferred to mating hardware and insulators.
- Cushioned insert surrounding conductor for superior protection of sensitive conductor components against wind and ice induced dynamic loads.
- Available with PARROT-BILL® Rod ends for EHV (345 KV and above) applications.

GENERAL SPECIFICATIONS

Vertical Strength: 25,000# (111kN) unless otherwise noted.

Slip Load: Approximately 20% of the conductor RBS initially (expected to increase after time in service).

Line Angle: Maximum of 30 for single suspension up to 60 for double suspension with yoke plate.

NOTE:

Add EHV to Catalog Number for PARROT-BILL Rod Ends.

Example: TLS-0100-EHV

Add CE to Catalog Number to include a Clevis Eye

Add YC to Catalog Number to include a Y-Clevis Eye

Add SE to Catalog Numbers to include a Socket Eye

Catalog Number		Diameter Range				Nominal	Length (overall)				Color Code	
Single	Double	Min. (in)	Max. (in)	Min. (mm)	Max. (mm)	Cond (kcmil)	Sgl (in)	Dbl (in)	Sgl (m)	Dbl (m)	Inner	Outer
TLS-0093	TLS-0293	0.574	0.590	14.6	15.0	207	98	120	2.49	3.05	Yellow	Green
TLS-0094	TLS-0294	0.619	0.636	15.7	16.2	257	98	120	2.49	3.05	Black	Black
TLS-0092	TLS-0292	0.637	0.673	16.2	17.1	267	100	120	2.54	3.05	Red	Brown
TLS-0095	TLS-0295	0.674	0.708	17.1	18.0	300	98	125	2.49	3.18	Orange	Orange
TLS-0096	TLS-0296	0.709	0.726	18.0	18.4	336.4	100	129	2.54	3.28	Green	Purple
TLS-0097	TLS-0297	0.727	0.759	18.5	19.3	336.4	100	129	2.54	3.28	Pink	Red
TLS-0098	TLS-0298	0.760	0.786	19.3	20.0	397.5	100	129	2.54	3.28	White	Blue
TLS-0099	TLS-0299	0.787	0.814	20.0	20.7	397.5, 477	100	129	2.54	3.28	Purple	Green
TLS-0100	TLS-0300	0.815	0.855	20.7	21.7	477	100	129	2.54	3.28	Red	Yellow
TLS-0101	TLS-0301	0.856	0.894	21.7	22.7	477, 556	100	132	2.54	3.35	Blue	Black
TLS-0102	TLS-0302	0.895	0.916	22.7	23.3	556	100	132	2.54	3.35	Black	White
TLS-0103	TLS-0303	0.917	0.942	23.3	23.9	556	100	132	2.54	3.35	Orange	Brown
TLS-0104	TLS-0304	0.943	0.977	23.9	24.8	605, 636	100	132	2.54	3.35	Green	Orange
TLS-0105	TLS-0305	0.978	1.016	24.8	25.8	636	100	132	2.54	3.35	Pink	Purple
TLS-0106	TLS-0306	1.017	1.057	25.8	26.8	636, 715	100	132	2.54	3.35	Purple	Red
TLS-0107	TLS-0307	1.058	1.079	26.8	27.4	715	112	149	2.84	3.78	White	Blue
TLS-0108	TLS-0308	1.080	1.112	27.4	28.2	795	112	149	2.84	3.78	White	Green
TLS-0109	TLS-0309	1.113	1.150	28.2	29.2	795, 954	112	149	2.84	3.78	Yellow	Yellow
TLS-0110	TLS-0310	1.151	1.188	29.2	30.2	954	112	149	2.84	3.78	Yellow	Black
TLS-0111	TLS-0311	1.189	1.208	30.2	30.7	954	112	149	2.84	3.78	Yellow	White
TLS-0112	TLS-0312	1.209	1.262	30.7	32.1	1033.5	125	154	3.18	3.91	Brown	Red
TLS-0113	TLS-0313	1.263	1.308	32.1	33.2	1113, 1192.5	125	154	3.18	3.91	Brown	Blue
TLS-0114	TLS-0314	1.309	1.338	33.2	34.0	1192.5	125	154	3.18	3.91	Red	Green
TLS-0115	TLS-0315	1.339	1.368	34.0	34.7	1272	125	154	3.18	3.91	Red	Yellow
TLS-0116	TLS-0316	1.369	1.409	34.7	35.7	1272, 1351.5	125	154	3.18	3.91	Blue	Black
TLS-0117	TLS-0317	1.410	1.449	35.7	36.8	1351.5, 1431	125	154	3.18	3.91	Black	White
TLS-0118	TLS-0318	1.450	1.490	36.8	37.9	1431, 1510.5	125	154	3.18	3.91	Orange	Brown
TLS-0119	TLS-0319	1.491	1.530	37.9	38.9	1510.5, 1590	125	154	3.18	3.91	Green	Orange
TLS-0120	TLS-0320	1.531	1.572	38.9	39.9	1590	125	154	3.18	3.91	Pink	Purple



THERMOLIGN® Suspension

DIMENSIONAL TABLES

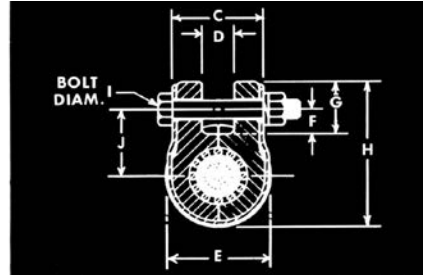
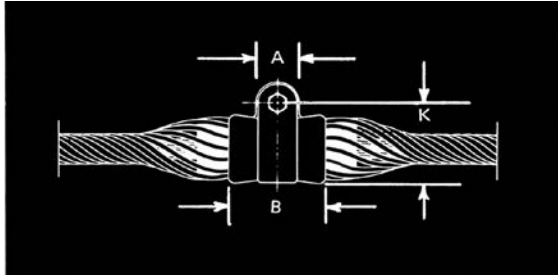

Catalog Number Range	Conductor Range (Inches)		Dimension (Inches)											Vertical Ultimate Strength (Pounds)	
	Min.	Max.	A	B	C	D	E	F	G	H	I	J	K		
TLS-0092	TLS-0095	0.574	0.708	2-1/4	5-1/2	3-1/2	1-3/16	4-5/32	1	2-1/8	5-29/32	5/8	2-45/64	4-25/32	25,000
TLS-0096	TLS-0100	0.709	0.855	2-1/4	6	3-5/8	1-1/4	4-13/16	1-1/4	2-3/8	6-11/16	3/4	3-5/32	5-9/16	25,000
TLS-0101	TLS-0106	0.856	1.057	2-1/4	6-1/2	4-1/8	1-3/8	5-1/16	1-1/8	2-1/4	6-5/8	3/4	2-31/32	5-1/2	25,000
TLS-0107	TLS-0112	1.058	1.262	2-1/2	7	4-11/16	2-1/4	5-19/32	1-1/8	2-3/8	7-1/4	3/4	3-3/16	6	25,000
TLS-0113	TLS-0120	1.263	1.613	2-1/2	7-1/2	5-7/32	2-13/32	6-1/16	1-3/16	2-7/16	7-25/32	3/4	3-1/2	6-17/32	30,000 (1)

EXPLANATORY NOTES:

(1) CE-5106 and YC-5211 are rated at 25,000 lbs. vertical ultimate strength. AGS® Rod length and diameter for individual sizes can be taken from the catalog number tables.

CLEVIS EYE

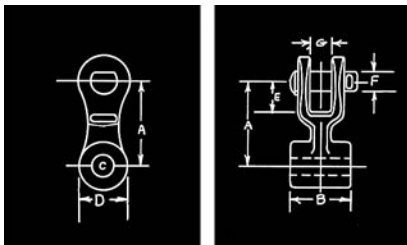

Catalog Number	Diameter Range (mm)	Dimensions (mm)						
		A	B	C	D	E	F	G
CE-5105	.574" - 1.057" (14.6 - 26.8)	3-1/8" (79)	1-1/16" (27)	13/16" (21)	1-1/2" (38)	1-1/2" (38)	5/8" (16)	13/16" (21)
CE-5106	1.058" - 1.572" (26.8 - 39.9)	3-1/8" (79)	2-1/8" (54)	13/16" (21)	1-1/2" (38)	1-1/2" (38)	5/8" (16)	13/16" (21)

Vertical Ultimate Strength - 25,000 lbs.

Y-CLEVIS EYE

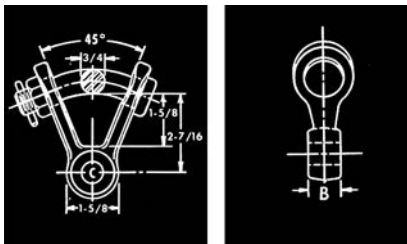

Catalog Number	Diameter Range (mm)	Dimensions (mm)	
		B	C
YC-5209	.574" - 1.057" (14.6 - 26.8)	1-1/16 (27)	13/16 (21)
YC-5211	1.058" - 1.572" (26.8 - 39.9)	2-1/8 (54)	13/16 (21)

Vertical Ultimate Strength - 25,000 lbs.

SOCKET EYE

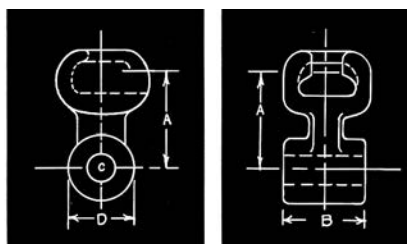

Catalog Number	Diameter Range (mm)	Dimensions (mm)				Vertical Ultimate Strength
		A	B	C	D	
SE-5154	.574" - 1.057" (14.6 - 26.8)	2-5/16" (59)	1-1/16" (27)	13/16" (21)	1-1/2" (38)	25,000 lbs
SE-5155	1.058" - 1.572" (26.8 - 39.9)	2-5/16" (59)	2-1/8" (54)	13/16" (21)	1-1/2" (38)	30,000 lbs

THERMOLIGN® Suspension

Vertical Bundling Link Assembly

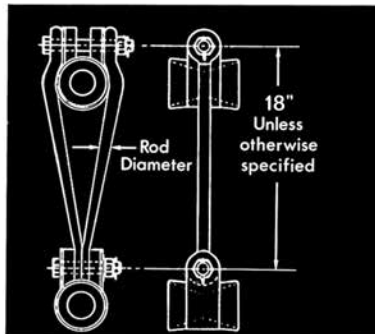
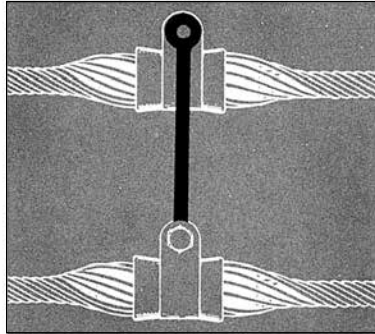

ULTIMATE RATED
STRENGTH 25,000*

THERMOLIGN Suspension Conductor Diameter Range (Inches)	Catalog Number †	Rod Diameter (Inches)	Bolt Diameter (Inches)	Center to Center of Eyes (Inches)
0.709 - 0.855	VBL-07	3/4	3/4	18
0.856 - 1.057	VBL-08	3/4	3/4	18
1.058 - 1.262	VBL-09	3/4	3/4	18
1.263 - 1.613	VBL-10	3/4	3/4	18

† Each assembly consists of two links and one hex bolt for top suspension with lockwasher and lock nut.
Center to center of eyes indicates vertical distance between conductors and will be 18" unless otherwise specified.
Add a -12" to the catalog number for 12" spacing (example: VBL-08-12).

Hold Down Weight Shackles *

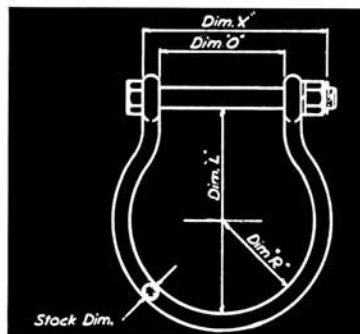
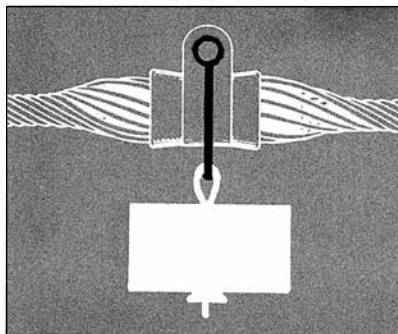

THERMOLIGN Suspension Conductor Diameter Range (Inches)	Hughes Brothers Stock No. †	Bolt Diameter (Inches)	Stock Dimeter (Inches)	Dim. "X" (Inches)	Dim. "O" (Inches)	Dim. "L" (Inches)	Dim. "R" (Inches)	Maximum Hold Down Weight (Lbs.)
0.709 - 0.855	1888.6	3/4	5/8	6	3-3/4	6-1/4	3	800
0.856 - 1.057	1888.7	3/4	5/8	6-1/2	4-1/4	6-1/2	3	800
1.058 - 1.262	1888.8	3/4	5/8	7-1/8	4-7/8	7-1/4	3-1/4	800

† Each assembly consists of a shackle body and hex-head bolt, lockwasher, nut, and Cotter Key.

* SPECIAL PRODUCT sold by Hughes Brothers, Inc., Seward, Nebraska (See page 1-44).

EXPLANATORY NOTE:

(1) CE-5106 and YC-5211 are rated at 25,000 lbs. vertical ultimate strength.