

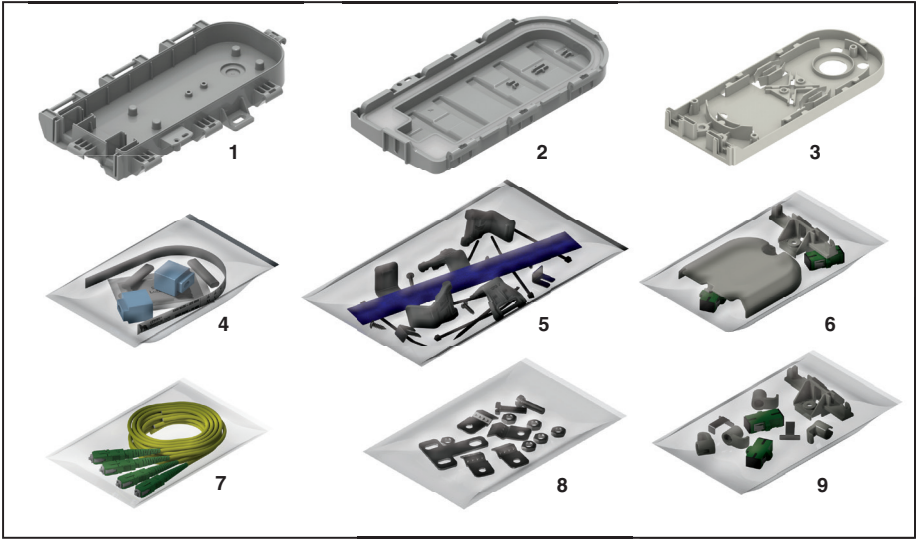

COYOTE® STP (Service Termination Point)

Be sure to read and completely understand this procedure before applying product. Be sure to select the proper PREFORMED™ product before application.



NOMENCLATURE

1. Base (1)
2. Cover (1)
3. Splice Platform (1)
4. Grommet Kit (1)
5. Small Parts Bag (1)

OPTIONAL ITEMS

6. Bulkhead Kit (1)
7. Pigtail Kit (1)
8. Bonding Kit (1)
9. Direct Cross-Connect Kit (1)

TOOLS REQUIRED

- 3/8" & 7/16" Can wrench or socket wrench
- Fiber optic cable opening tools
- Phillips Screwdriver
- Snips

COYOTE STP Kits and Accessories	
PLP Catalog Number	Description
STP-GG-1-N-0-N	COYOTE STP Kit – Splice Only: Includes (2) G Grommets
STP-EE-2-N-0-N	COYOTE STP Kit – Splice Only with Bonding: Includes (2) E Grommets
STP-GG-3-1-2-2	COYOTE STP Kit – Cross-Connect: Includes (2) G Grommets, (2) SCAPC Adapters, and (4) 3 mm Yellow Jacketed Pigtails
STP-GG-3-1-1-2	COYOTE STP Kit – Cross-Connect: Includes (2) G Grommets, (1) SCAPC Adapters, and (2) 3 mm Yellow Jacketed Pigtail
STP-EE-4-1-2-2	COYOTE STP Kit – Cross-Connect with Bonding: Includes (2) E Grommets, (2) SCAPC Adapters, and (4) 3 mm Yellow Jacketed Pigtails
STP-HH-5-1-2-N	COYOTE STP Kit – Direct Cross-Connect: Includes (2) H Grommets and (2) SCAPC Adapters
80061322	COYOTE STP Cable Shroud Kit
80061323	COYOTE STP Pedestal Mounting Bracket Kit for Charles Industries PEDLOCK® BD4 and BD5 Buried Cable Pedestals

General Cable Preparation

Step #1 Measure each cable to determine the diameter of the cable and select the proper grommet(s) for your application.

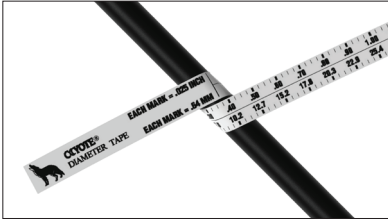

NOTE: The lines on each grommet represent the slit locations for cables expressing fiber or pre-connectorized drop cables.

Small Grommets		Cable Diameter Range
A		SOLID / NO HOLE
B		FOR ROUND DROP DIAMETERS .100" - .154" (2.5 - 3.9 mm)
C		FOR ROUND DROP DIAMETERS .154" - .25" (3.9 - 6.4 mm)
D		FOR ROUND DROP DIAMETERS .25" - .35" (6.4 - 8.9 mm)
E		FOR ROUND DROP DIAMETERS .35" - .389" (8.9 - 9.9 mm)
F		FOR ROUND DROP DIAMETERS .389" - .425" (9.9 - 10.8 mm)
G		FOR FLAT DROP CABLES
H		FOR ROUND DROP DIAMETERS .100" - .123" (2.5 - 3.1 mm)
J		FOR ROUND DROP DIAMETERS .154" - .188" (3.9 - 4.8 mm)

Step #2 Insert each cut cable in the appropriate grommet. If the cable is expressing fiber, slit the grommets as shown below before installing the grommets over the cable. **(See Step #1 for slit locations for each grommet)**

For Cut Applications

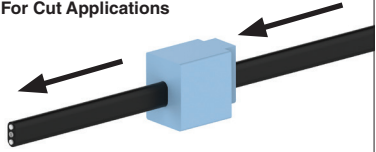

For Expressed Applications

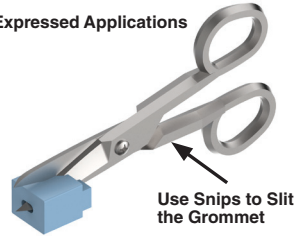

For Expressed Applications

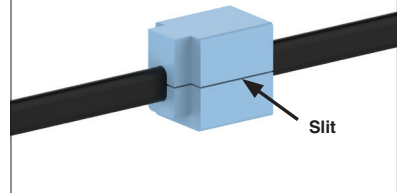

Step #3 If the cable is a figure 8 style cable or has a tracer wire, remove the ground wire or tracer wire from the portion of the cable that will be positioned in the grommet and insert the cable into the grommet. Remove any burrs left on the cable caused by separating the tracer wire from the sheath.

Cable with Tracer Wire

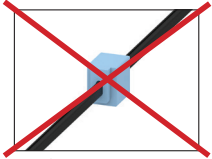

Not Correct Installation

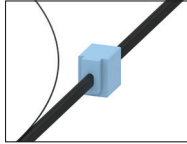

Correct Installation

Figure 8 Style Cable

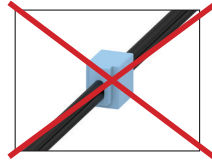

Not Correct Installation

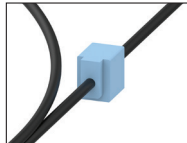

Correct Installation

Step #4 Install a plug into any unused hole of each grommet.

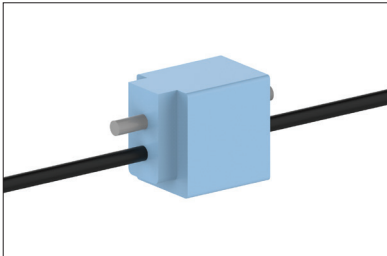

Step #6 Measure, mark, and remove the cable sheath for expressed fiber applications as shown below.

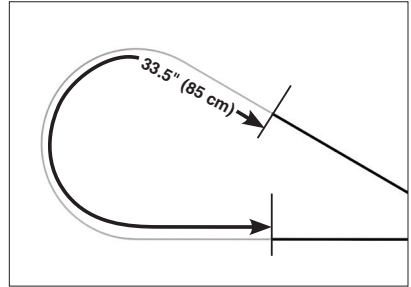

Preparation of the Drop Cables

Flat Drop Cables

Step #7 Trim the cable strength members as close to the cable sheath opening as possible and remove the buffer tube 1/2" (13 mm) away from the sheath opening.

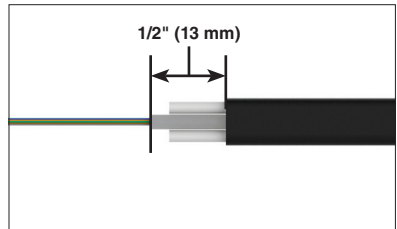
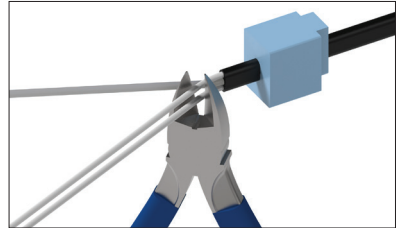

Step #5 Measure, mark, and remove the cable sheath for cut cable applications as shown below.

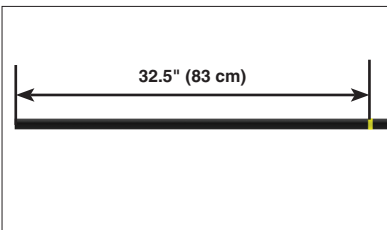

Round Drop Cables without Aramid Yarn

Step #8 Remove the buffer tube 1/4" (6 mm) away from the sheath opening.

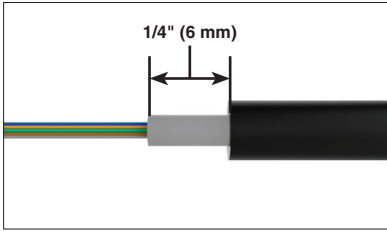

Installation of Flat Drop Cables in the Splice Platform

Step #11 Adjust the cable so that the cable sheath opening is positioned 1" (25.4 mm) from the grommet.

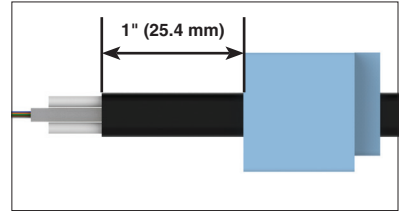

Round Drop Cables with Aramid Yarn

Step #9 Remove the buffer tube 1/4" (6 mm) away from the sheath opening. Braid roughly 2" (51 mm) of aramid yarn.

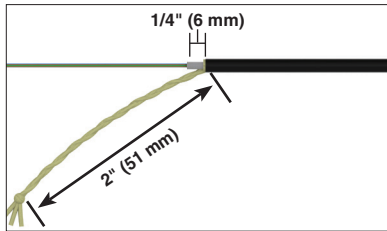

Step #12 Align the cable sheath opening with the edge of the retention tab of the platform and insert the cable retention clip into the retention clip slot.

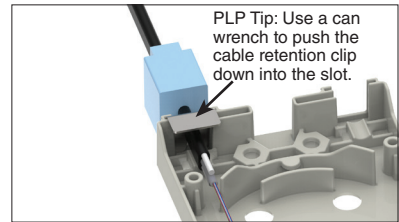
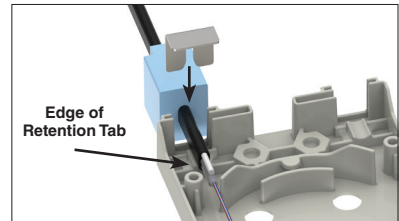

Armored Round Drop Cables

Step #10 Remove the armor 1" (25 mm) away from the sheath opening. Remove the buffer tube 1/4" (6 mm) away from the end of the armor. Bend the steel strength members 90 degrees and cut them 3/4" (19 mm) from the bend at the sheath opening.

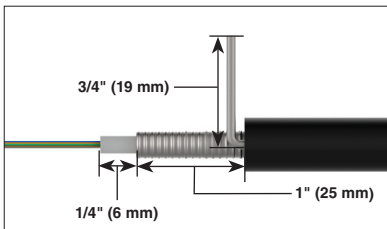

Installation of the Round Drop Cables without Aramid Yarn in the Splice Platform

Step #13 Install a tie wrap under the cable retention tab of the platform.

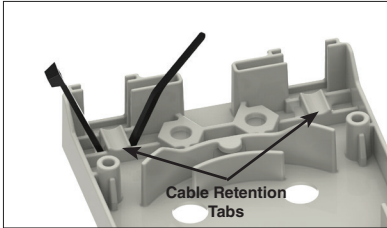

Step #16 Wrap the end of the cable with a piece of felt and secure the cable to the retention tab with the tie wrap.

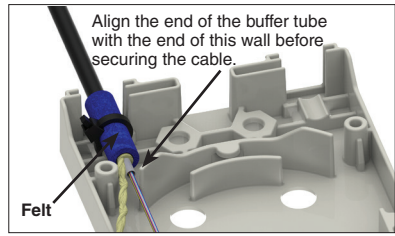

Step #14 Wrap the end of the cable with a piece of felt and secure the cable to the retention tab with the tie wrap.

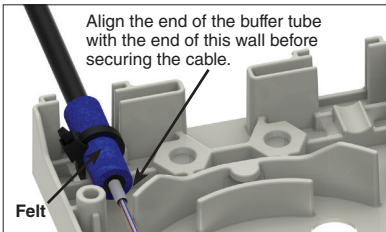

Step #17 Install a self-tapping screw halfway in the boss next to the cable.

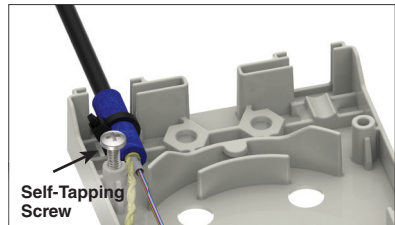

Installation of the Round Drop Cables with the Aramid Yarn in the Splice Platform

Step #15 Install a tie wrap under the cable retention tab of the platform.

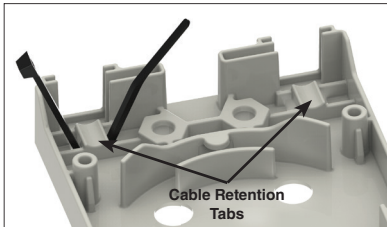

Step #18 Wrap the braided aramid yarn clockwise around the threads of the screw and tighten the screw down.

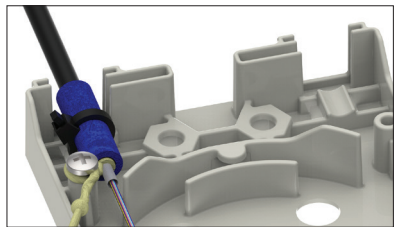

Installation of the Round Armored Drop Cables in the Splice Platform

Step #19 Place a bolt through the bottom of the platform and place one of the bonding clamp halves on the bolt as shown below.

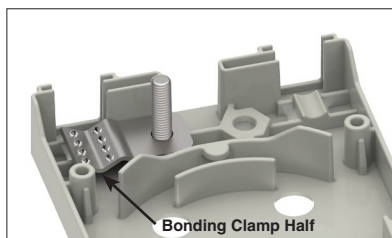
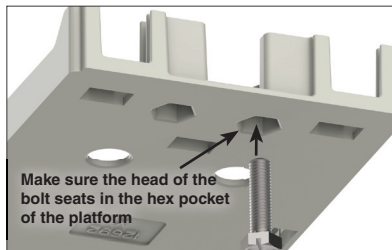

Step #20 Position the bent steel strength members of the armored drop cable into the side retention pocket of the platform.

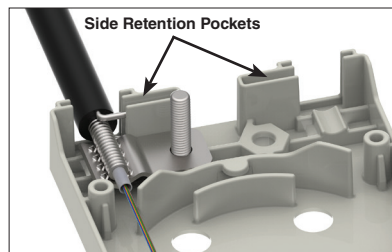
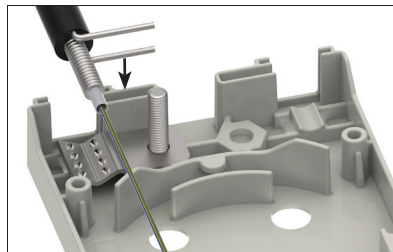

Step #21 Place the other half of the bonding clamp on the bolt as shown below. Install a small hex jam nut on the bolt and tighten the nut to secure the cable.

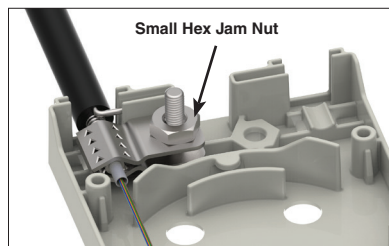

Fiber Routing in the Platform

Step #22 Route the expressed fibers.

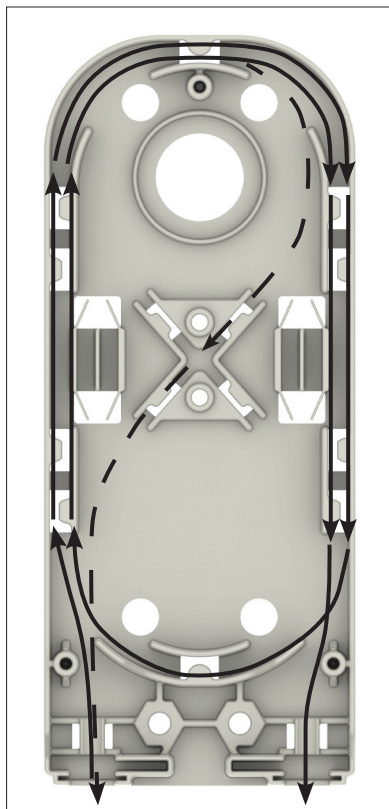

Straight Splice Applications

Step #23 Route the **incoming** fibers.

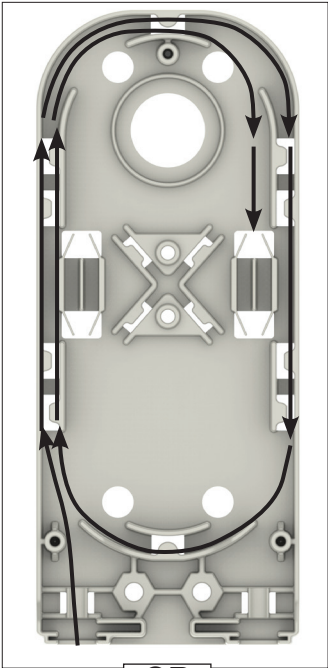

OR

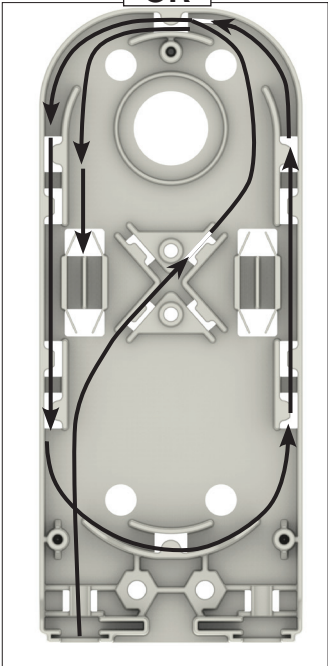

Step #24 Route the **outgoing** fibers.

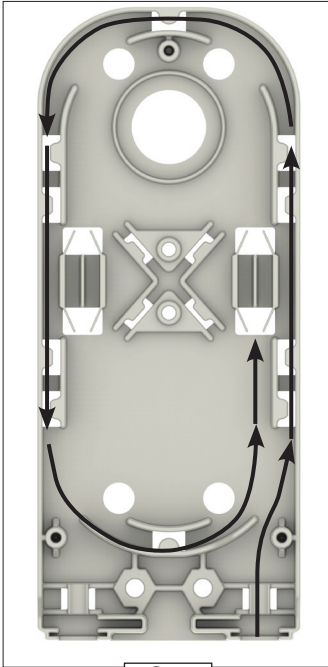

OR

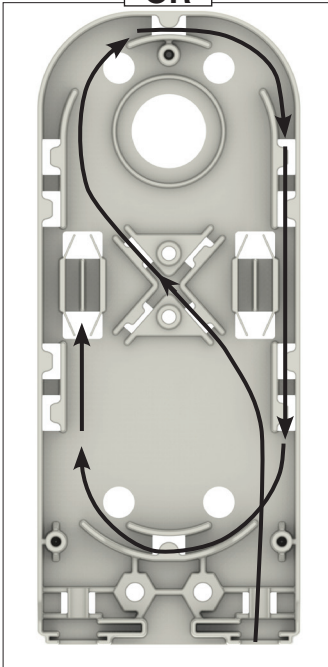

Step #25 Splice the **incoming** fibers to the outgoing fibers per your accepted company practice.

Standard Cross-Connect Applications

Step #26 Route the **incoming** fibers.

Incoming Fiber 1

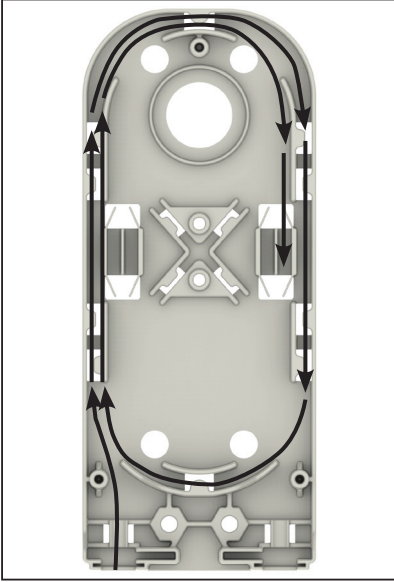

Incoming Fiber 2

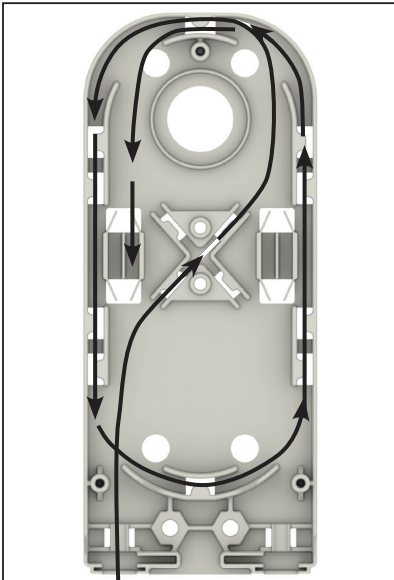

Step #27 Route the **outgoing** fibers.

Outgoing Fiber 1

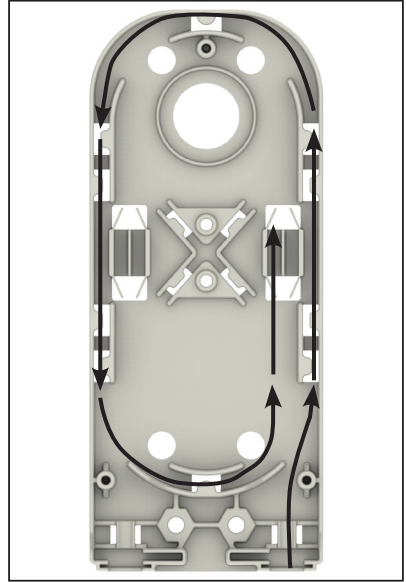

Outgoing Fiber 2

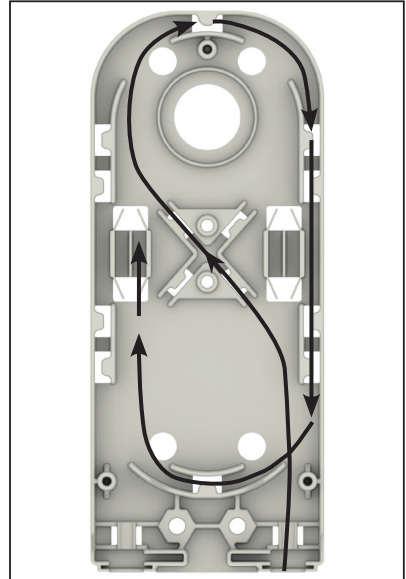

NID Applications

Step #28 Route the incoming fibers.

Incoming Fiber 1

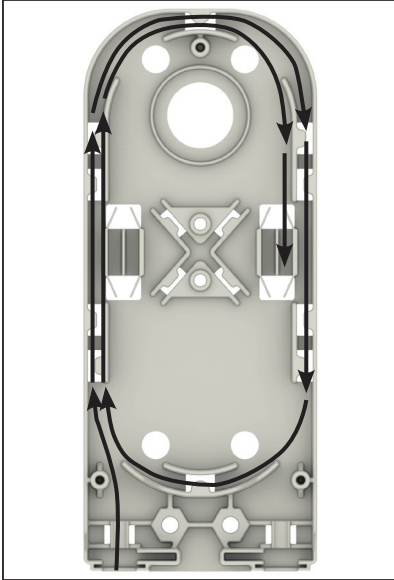

Incoming Fiber 2

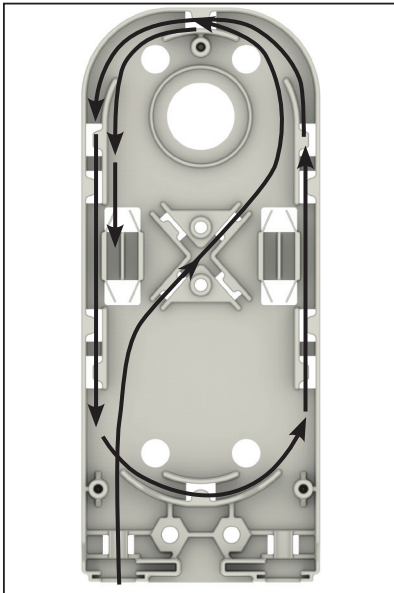

NOTE: If needed, a fiber pick is included to help maneuver the fibers into the routing channels of the platform.

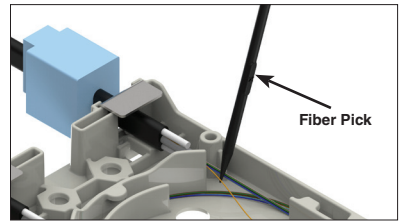

Preparation and Routing of Pigtails for Cross-Connect Applications

Step #29 Measure and mark the jacket of the pigtail(s) as shown below. Remove the jacket of the pigtail(s) beyond the marked location.

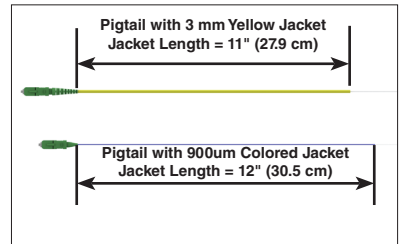

Step #30 Splice the incoming fiber(s) to the incoming pigtail(s) and the outgoing fiber(s) to the outgoing pigtail(s) per your accepted company practice.

Standard Cross-Connect Applications

Step #31 Route the **incoming** pigtail(s) in the platform from the splice to the bulkhead location.

Routing for 1st Incoming Pigtail

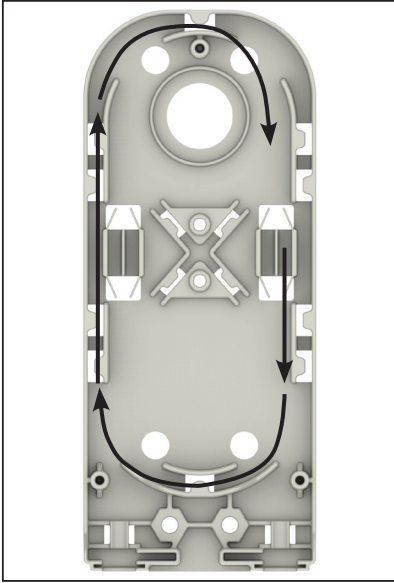

Routing for 2nd Incoming Pigtail

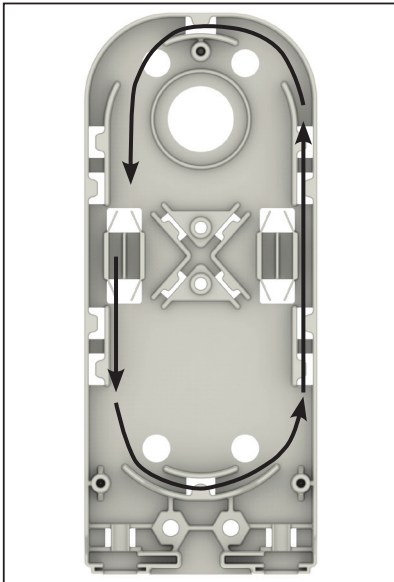

Step #32 Route the **outgoing** pigtail(s) in the platform from the splice to the bulkhead location.

Routing for 1st Outgoing Pigtail

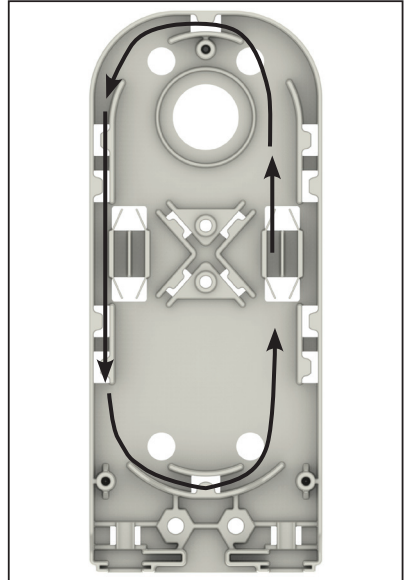

Routing for 2nd Outgoing Pigtail

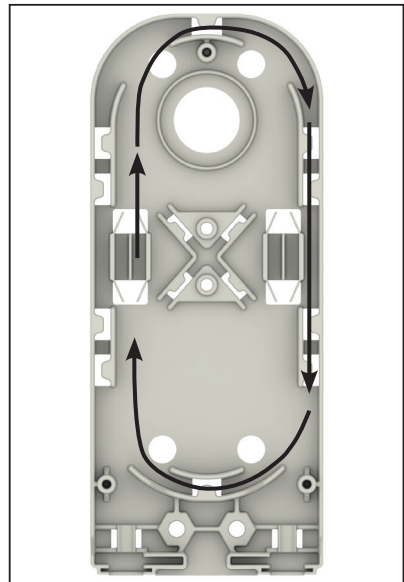

NID Applications

Step #33 Route the incoming pigtail(s) in the platform from the splice to the bulkhead location.

Routing for 1st Incoming Pigtail

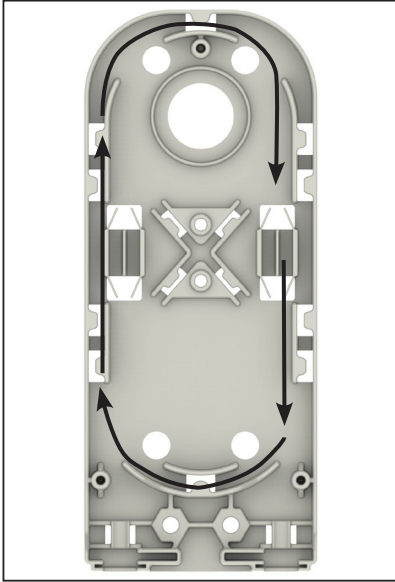

Routing for 2nd Incoming Pigtail

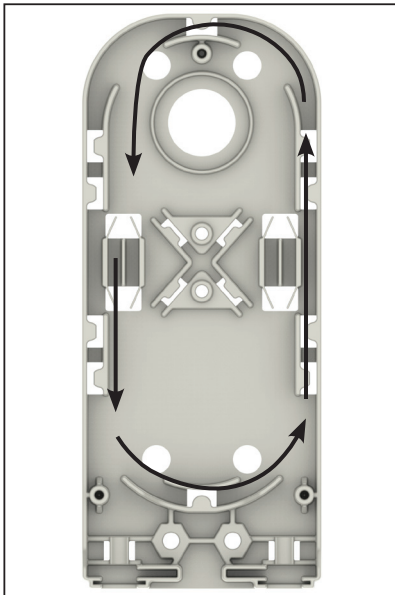

Step #34 Install the adapter(s) into the bulkhead bracket.

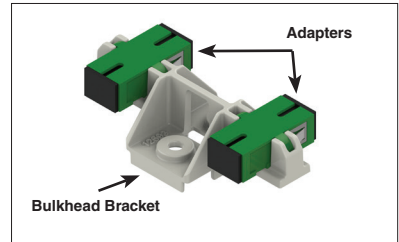

Step #35 Place the bulkhead bracket onto the platform and insert the pigtail connector(s) into the adapter(s).

Standard Cross-Connect

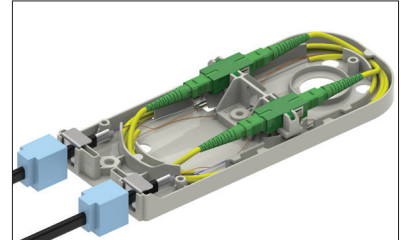

NID

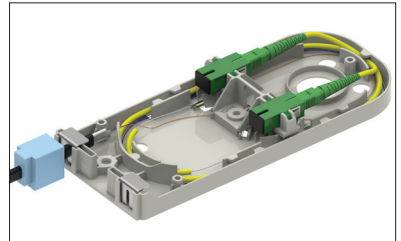

Installation of Splice Platform into the Base

Step #36 Adjust each grommet so that they are positioned 1/4" (6 mm) from the platform.

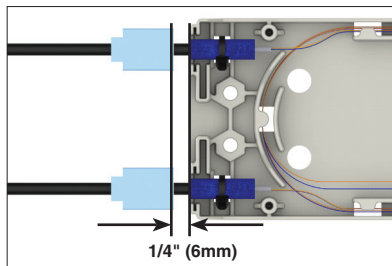

Step #37 Lubricate all four outer surfaces of each grommet. Once the lubricant has been applied, smear it to provide a light coating on each surface.

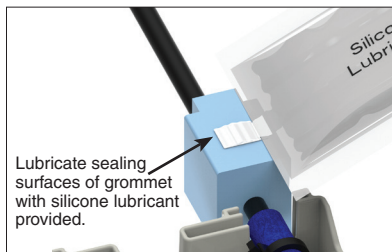

Standard Straight Splice and Cross-Connect Applications

Step #38 Place the platform onto the posts located in the base while inserting the grommets into the grommet pockets of the base.

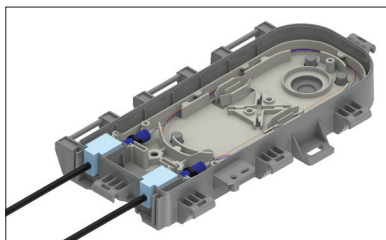
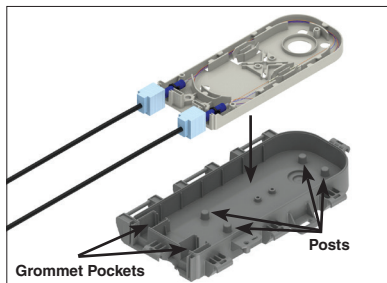

Step #39 Secure the platform to the base with the self-tapping screws that are provided as shown below.

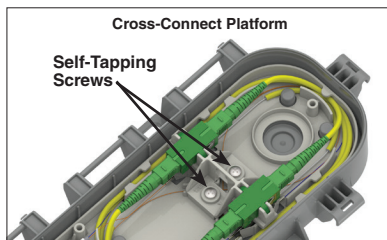
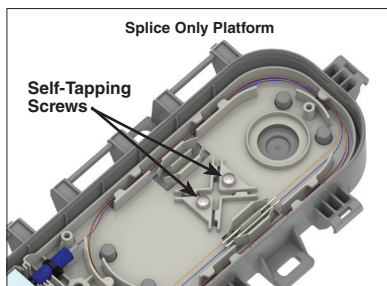

NID Applications

Step #40 Using a hole saw, drill a 7/8" (22 mm) hole through the outside wall of the house/building/structure as shown below.



Step #41 Using a hole saw, drill a 7/8" (22 mm) hole through the pass through port of the base.

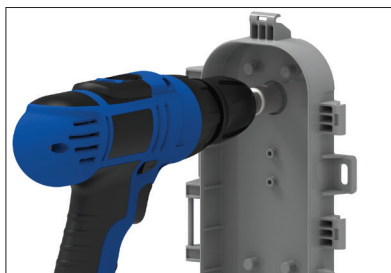

Step #42 For applications where conduit will be used, make sure that the conduit is no larger than .840" (21 mm) O.D. While installing the conduit make sure to adjust the conduit so that when the base is installed on the wall the threaded portion of the conduit protrudes 1/4" (6 mm) through the base.

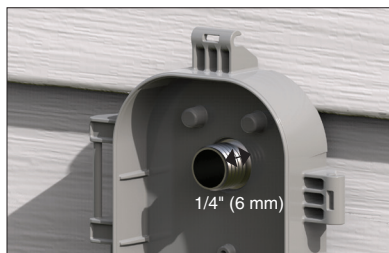

Step #43 Place sealant around the pass through port on the back of the base per your standard company practice.

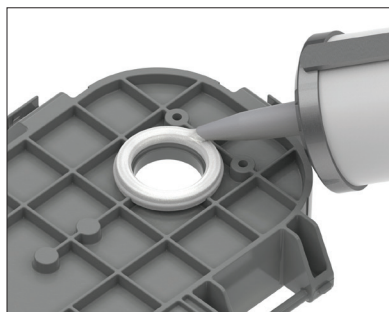

Step #44 Align the pass through port with the hole or conduit in the wall and mount the base to the wall of the house/building/structure with screws or bolts (not provided). **IMPORTANT NOTE: If cable bonding/grounding is required, see Step 53 prior to securing the base to the wall.**

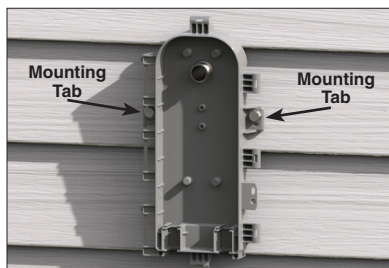

Step #45 Place the platform onto the posts located in the base while inserting the grommet(s) into the grommet pocket(s) of the base.

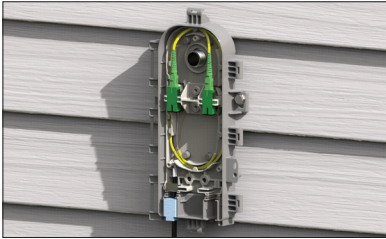
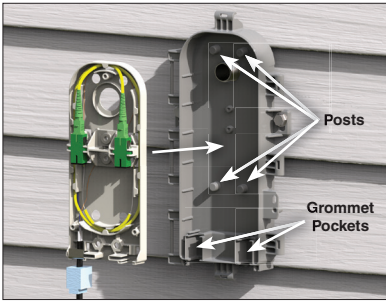

Step #48 If only one cable is entering the closure, then lubricate (Step 37) and insert either a grommet with a plug or a solid grommet into the empty grommet pocket.

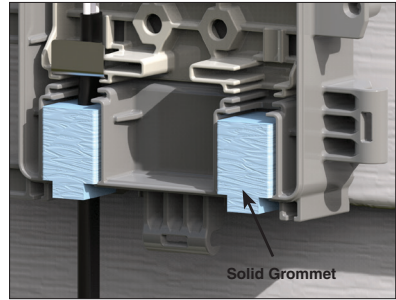

Step #49 Route the outgoing pigtails in the platform.

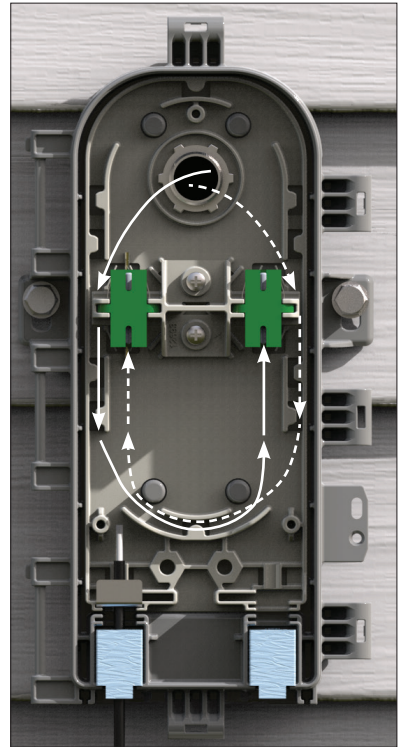

Step #46 Secure the platform to the base with the self-tapping screws that are provided as shown below.

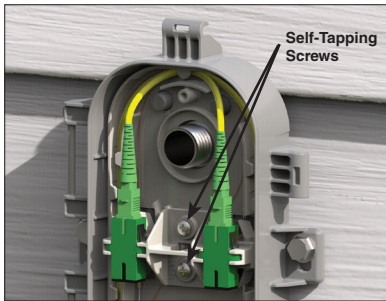

Step #47 For applications where conduit is used, secure the conduit to the base with a lock nut (not provided).

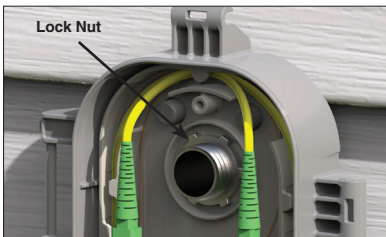

Step #50 Insert the connectors of the outgoing pigtails into the adapters of the bulkhead.

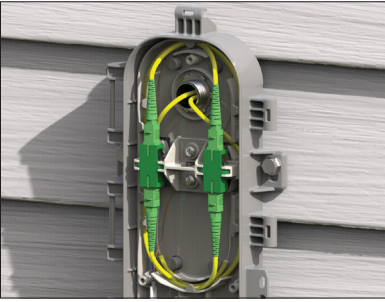

Installation of the Bulkhead Shroud onto the Platform (Standard Cross-Connect and NID Applications)

OPTIONAL STEP: Angle the shroud and place the tab of the shroud in the slot of the bulkhead. Rotate the shroud downward and secure the shroud to the platform with a self-tapping screw.

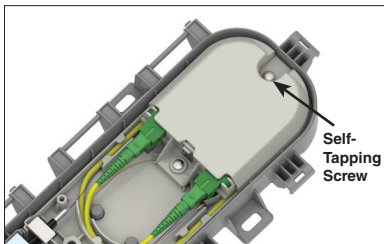
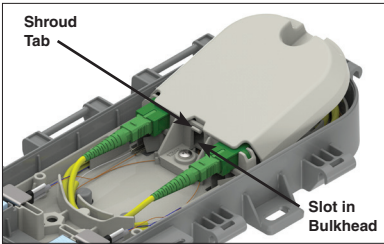

Bonding Armored Drop Cables

Step #51 Remove the protective cap from the ground stud. Place the bonding bracket on the bonding clamp bolt(s) and the ground stud of the base. Secure the bracket to each bonding clamp bolt with a small hex jam nut.

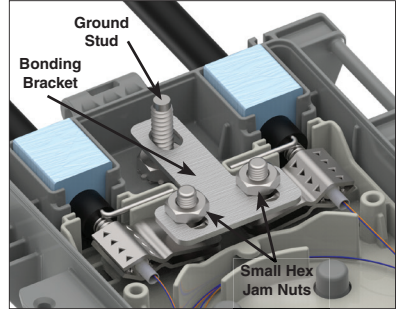

Step #52 Secure the bonding bracket to the ground stud with the large hex nut.

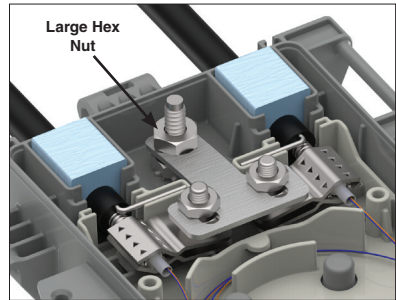

Step #53 Attach a ground wire to the ground stud with the large hex jam nut and ground per your standard company practice.

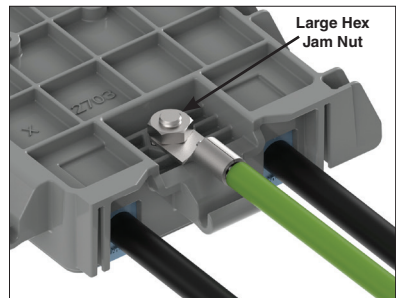

Direct Cross-Connect Applications

Step #54 Install the adapter(s) into the bulkhead bracket and secure the bulkhead bracket to the base with the self-tapping screws that are provided.

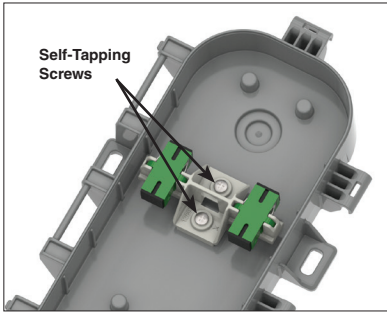

Step #55 Install the push on routing clips onto the posts of the base as shown below.

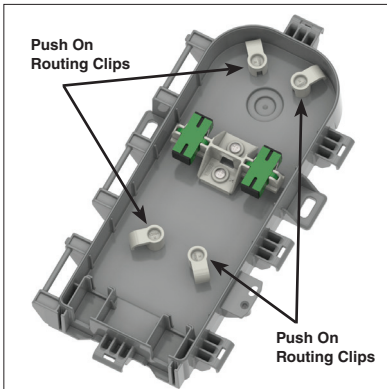

Step #56 For NID applications follow **Steps 40–44**. If conduit is used, secure the conduit directly to the base with a lock nut (not provided).

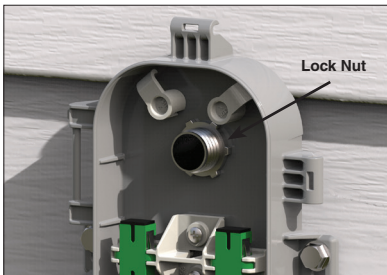

Cable Routing for Standard Application

Step #57 Route the **incoming** cable(s) in the platform and install the connector into the adapter.

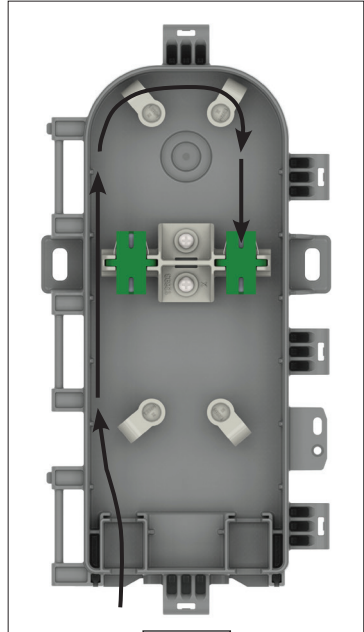

OR

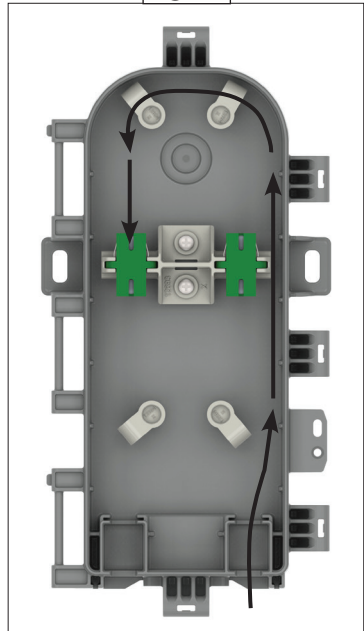

Step #58 Route the **outgoing** cable(s) in the platform and install the connector into the adapter.

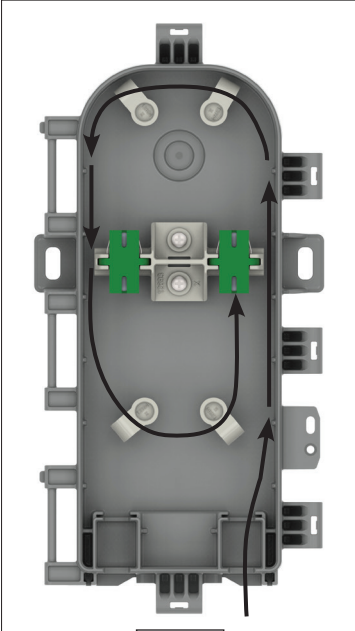

OR

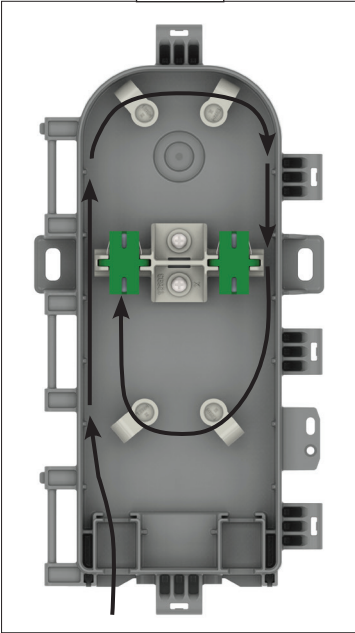

Cable Routing for NID Application

Step #59 Route the **incoming** cable(s) in the platform and install the connector into the adapter.

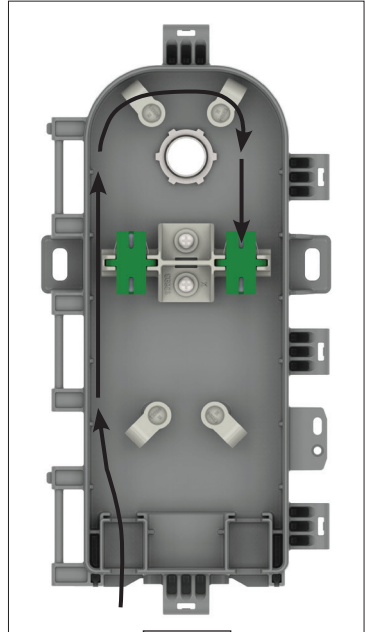

OR

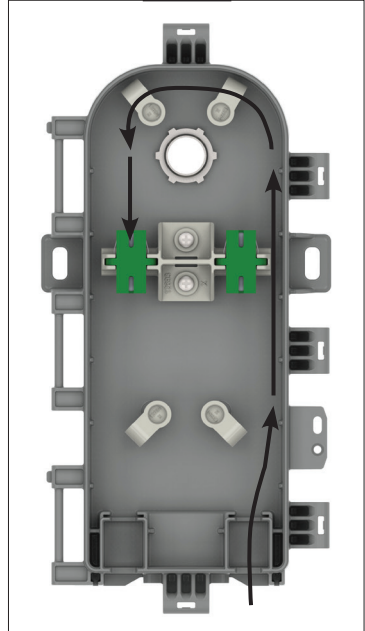

Step #60 Route the **outgoing** cable(s) in the platform and install the connector into the adapter.

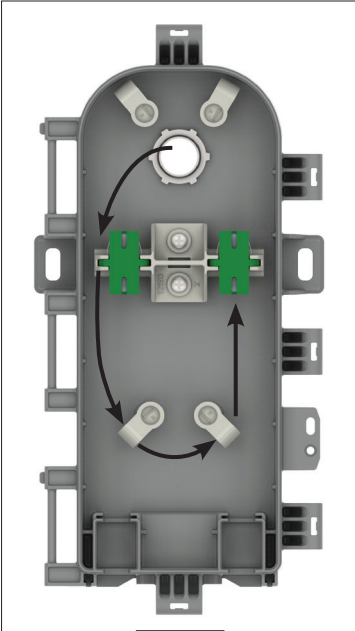

OR

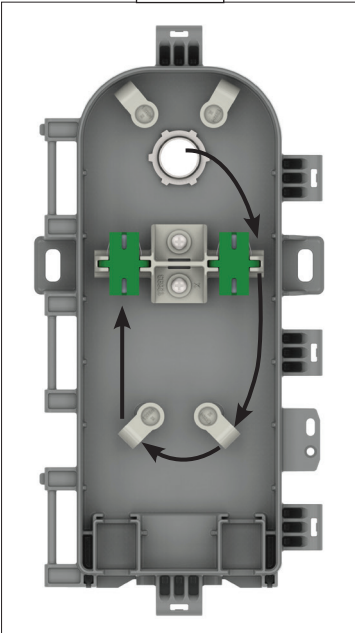

Flat Drop Cables

Step #61 Lubricate the grommet(s) (See Step 37) and place them into the grommet pocket(s). If there is an empty grommet pocket, make sure to install a grommet with a plug or a solid grommet in it.

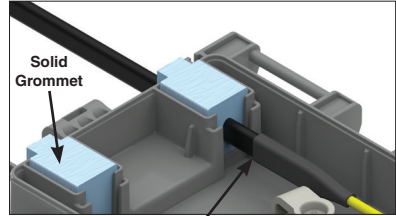

The end of the cable heat shrink should be positioned at least 1/2" (13 mm) away from the grommet.

Step #62 Insert the cable retention clip(s) into the retention clip slot(s) of the base.

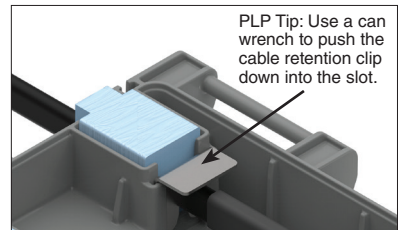
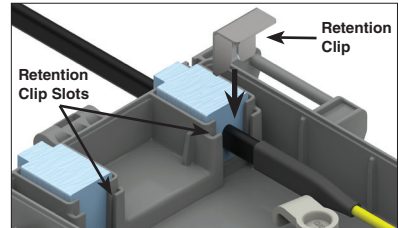

PLP Tip: Use a can wrench to push the cable retention clip down into the slot.

Round Drop Cables

Step #63 Place the tie wrap retention clip(s) into the retention clip slot(s) of the base as shown below.

1 Cable per Port

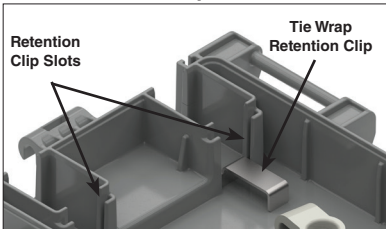

2 Cables per Port

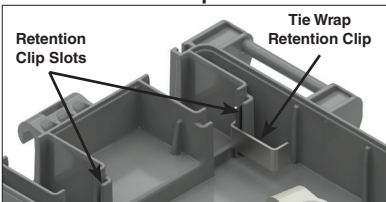

Step #65 Secure the cable(s) to each retention clip with tie wraps.

1 Cable per Port

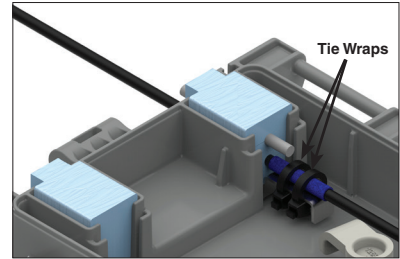

2 Cables per Port

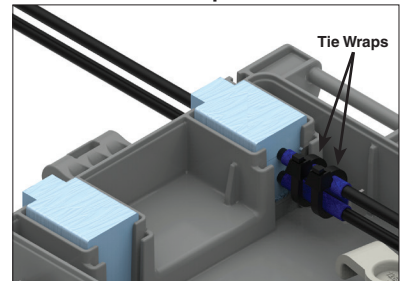

Step #64 Lubricate the grommet(s) (See Step 37) and place them into the grommet pocket(s). If there is an empty grommet pocket, make sure to install a grommet with a plug or a solid grommet in it. Adjust the cable(s) as needed before placing a piece of felt around the cable(s) where the tie wrap retention clip is located.

1 Cable per Port

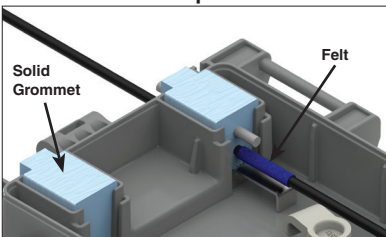

2 Cables per Port

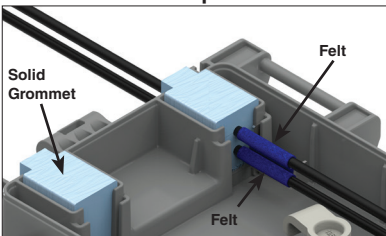

Installation of the Cover and Latches

Step #66 Position the hinges of the cover in the gap between the hinge posts and the outside wall of the base.

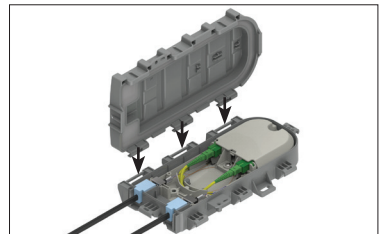

Step #67 Rotate the cover down until the hinge posts engage into the hinges of the cover.

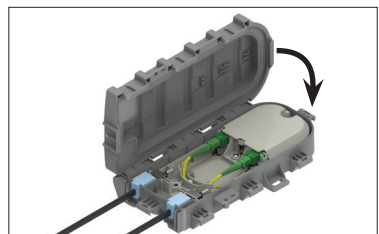

Step #67 CONTINUED

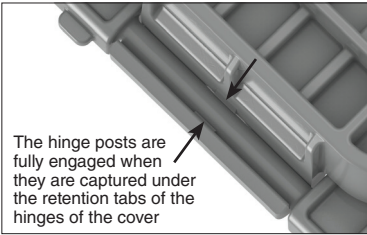

The hinge posts are fully engaged when they are captured under the retention tabs of the hinges of the cover

Step #68 To lock the cover in the open position, rotate the cover until the retention tabs of the base snap over the edge of the cover.

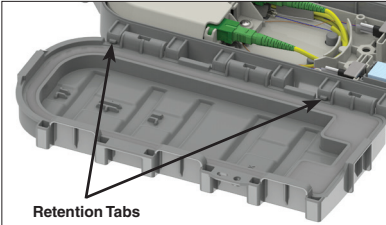

Retention Tabs

Step #69 Store the fiber pick in the holder of the cover.

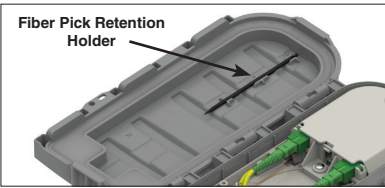

Fiber Pick Retention Holder

Step #70 Install the latches onto the base and rotate the cover to the closed position. Secure the cover by pressing down on it while rotating the latches until they snap in place over the cover.

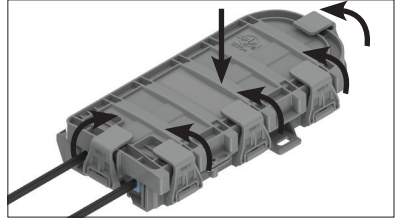
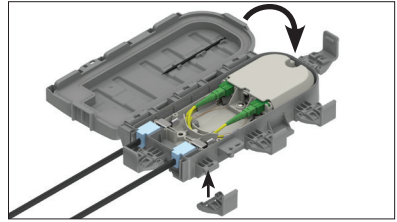

Step #71 Secure the cover to the base with the pin-in torx head self-tapping screw that is provided or use the security slot to use some other method that follows your standard company practice.

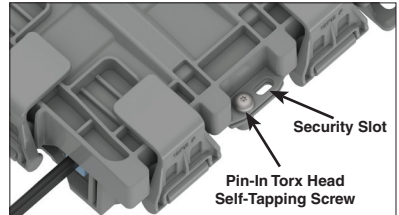

Security Slot

Pin-In Torx Head Self-Tapping Screw

SAFETY CONSIDERATIONS

This application procedure is not intended to supersede any company construction or safety standards. This procedure is offered only to illustrate safe application for the individual. FAILURE TO FOLLOW THESE PROCEDURES MAY RESULT IN PERSONAL INJURY OR DEATH.

Do not modify this product under any circumstances.

This product is intended for use by trained technicians only. This product should not be used by anyone who is not familiar with, and not trained to use it.

When working in the area of energized lines, extra care should be taken to prevent accidental electrical contact. Be sure to wear proper safety equipment per your company protocol.

For proper performance and personal safety, be sure to select the proper size PREFORMED™ product before application.

PREFORMED products are precision devices. To ensure proper performance, they should be stored in cartons under cover and handled carefully.



PREFORMED LINE PRODUCTS

P.O. Box 91129, Cleveland, Ohio 44101 • 440.461.5200 • preformed.com • email: inquiries@preformed.com

SP3396-2