

COYOTE[®] HD Dome Closure

The **COYOTE HD (High-Density) Dome Closure** offers an alternative fiber organizer to support high-density splice applications within the same footprint as PLP's existing 9.5" x 28" COYOTE Dome Closure. The new organizer architecture provides open access for fiber routing, reduces cable sheath openings, and simplifies assembly: all factors that save you time and money. When combined with PLP's patented segmented end plate design, the closure system offers the ultimate level of flexibility to address your complex network needs.

Features and Benefits

- Maximum Splice Capacity of 1728 or 3456 depending on cable construction
- 7-Port segmented end plate design provides independent access to each cable port without disrupting surrounding cables
- Two splice tray designs to support mass fusion splicing, single fusion, or a combination of both
- Modular tray design permits trays to hinge upward or be removed from the stack to allow multiple splicers to work simultaneously
- Grommet range now accepts fiber optic cable entry of up to 1.38" in diameter
- Designed and tested in accordance to Telcordia[®] GR-771-CORE Buried, Underground, IP-68 Rated Requirement



▶ The COYOTE HD features PLP's patented segmented end plate system which allows independent access to each cable port without disrupting surrounding cables. The cable take-up ability of the COYOTE silicone grommets, paired with the chemically bonded hard and soft polymer of the end plate cap, provides a secure seal around a wide variety of cable profiles, eliminating the need for scuffing, adhesives, sealing tapes, or cure times. The cable restraint hardware provides proper pull-out strength and restricts strength member pistoning inside the closure.



▶ The COYOTE HD Deep Profile Mass Fusion Splice Tray (Catalog Number: 80813121), permits storage of slack ribbon fibers and splicing of up to 288 fibers on the same splice tray. This design feature eliminates the need to house slack storage in a slack basket.

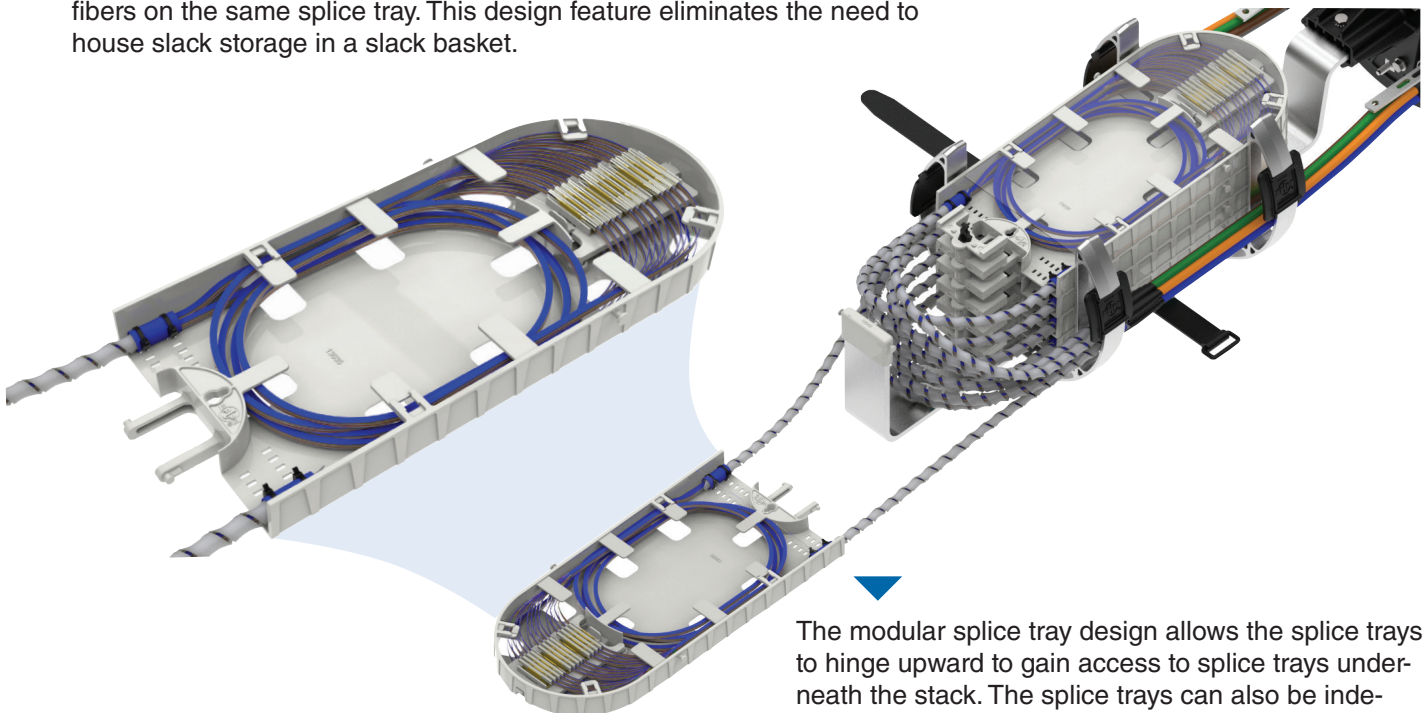

▶ The modular splice tray design allows the splice trays to hinge upward to gain access to splice trays underneath the stack. The splice trays can also be independently removed from the stack, allowing multiple splicers to work simultaneously outside of the closure footprint, ultimately speeding up network deployment.

▶ The COYOTE Breakout Kit (Catalog Number: 80061500) is used to organize, protect, and breakdown unitube ribbon cables into smaller, more manageable ribbon subsets prior to routing to a splice tray, when a slack basket is not available. It is compatible with unitube ribbon cables from 864F down. In conjunction with the COYOTE Breakout Kit, all cable restraint hardware

and shield bonds can be attached outside of the COYOTE HD Dome Closure's footprint prior to entry into the end plate. The COYOTE Breakout Kit consists of a base, snap-on cover, (6) 1/4" ID x 36" LLDPE transition tubes, felt tape, and zip-ties. Each transition tube is capable of routing (12) 12-fiber ribbon matrices or 144 fibers to a splice tray.

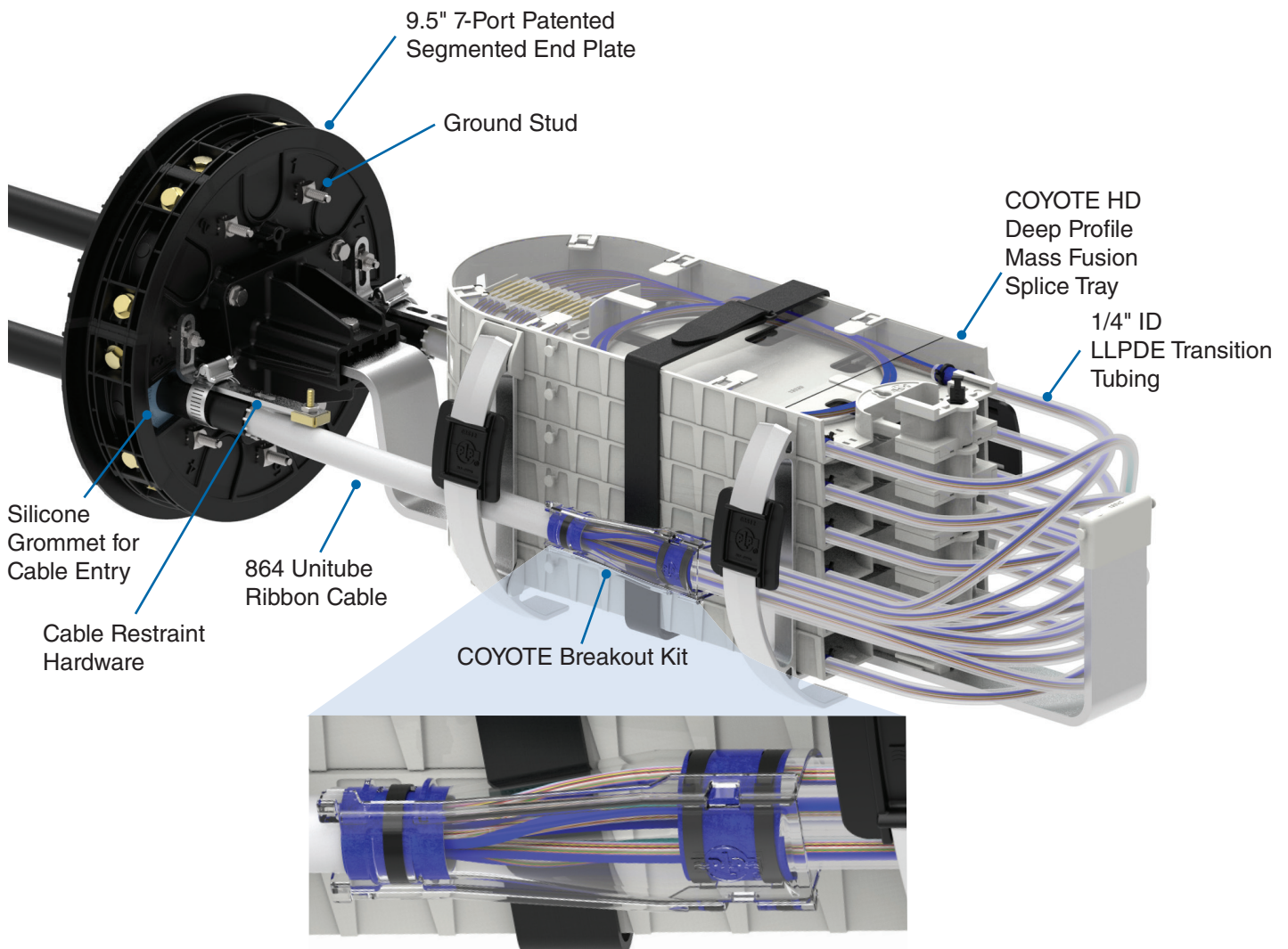

▶ COYOTE® HD Dome Closure Tray Stacking for Ribbon Applications

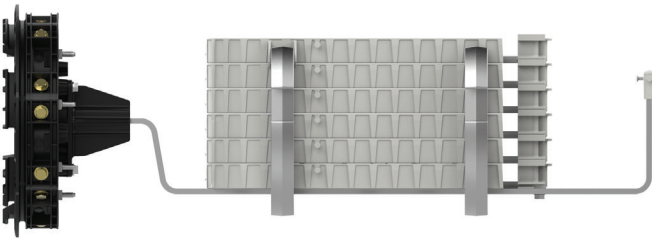

Catalog Number 80061406
with (6) 80813121 Splice Trays
Maximum Splice Capacity – 1728 Ct.

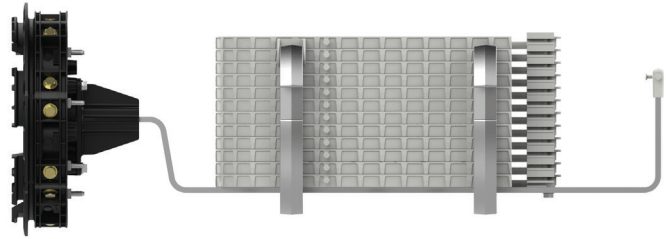

Catalog Number 80061406
with (12) 80813122 Splice Trays
Maximum Splice Capacity – 3456 Ct.
(used for end of reel splice with collapsible ribbon)

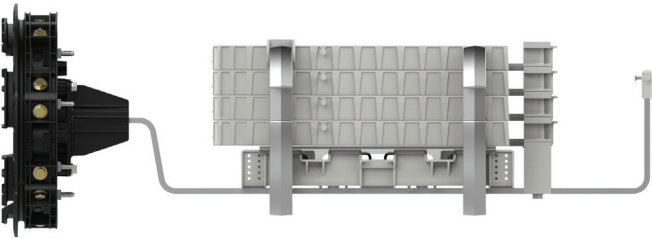

Catalog Number 80061407
with (4) 80813121 Splice Trays
Maximum Splice Capacity – 1152 Ct.

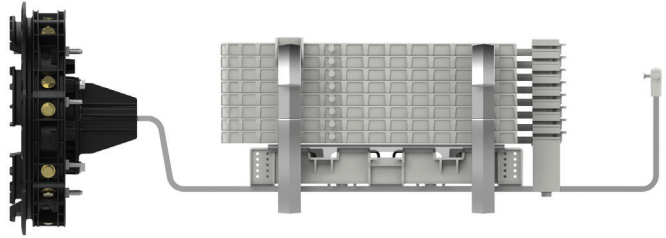

Catalog Number 80061407
with (8) 80813122 Splice Trays
Maximum Splice Capacity – 2304 Ct.

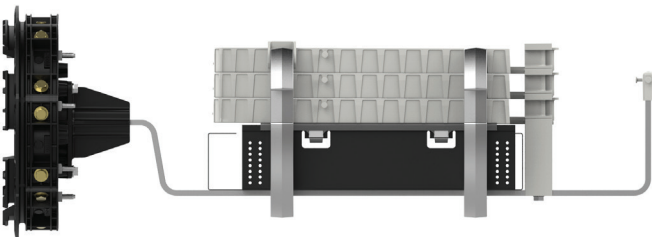

Catalog Number 80061406 and 80813267
with (3) 80813121 Splice Trays
Maximum Splice Capacity – 864 Ct.

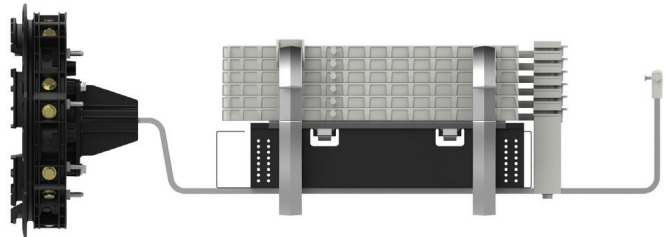

Catalog Number 80061406 and 80813267
with (6) 80813122 Splice Trays
Maximum Splice Capacity – 1728 Ct.

▶ COYOTE® HD Dome Closure for Ribbon Applications

Specifications	WITHOUT Slack Basket, Cables Less Than 1.25" in. Dia.	WITH Slack Basket, Cables Less Than 1.25" in. Dia.
Catalog Numbers	80061406	80061407
Splice Capacity (Maximum) – Single Fusion (Thin, 80813123), Mass Fusion (Thin, 80813122), Mass Fusion (Deep, 80813121)	864, 3456 ¹ , 1728	576, 2304 ¹ , 1152
Number of Splice Trays – 80813123, 80813122 ¹ , 80813121	12, 12, 6	8, 8, 4
Cable Ports ²	7	7
Cable Diameters	0.093" – 1.25" (2.4 – 31.8 mm) and Flat Drop	0.093" – 1.25" (2.4 – 31.8 mm) and Flat Drop
Ground Studs	7	7
Configuration	Butt	Butt
Application	Direct Bury, Below Grade, Pole/Wall, Aerial	Direct Bury, Below Grade, Pole/Wall, Aerial
Ingress Protection	In accordance to Telcordia® GR-771-CORE, Buried, Underground; IP-68	In accordance to Telcordia® GR-771-CORE, Buried, Underground; IP-68
Size ⁴	13.3" W x 29.4" L (338 x 747 mm)	13.3" W x 29.4" L (338 x 747 mm)

Specifications	WITHOUT Slack Basket, Cables Greater Than 1.25" in. Dia.	WITH Slack Basket, Cables Greater Than 1.25" in. Dia.
Catalog Number	80061408	80061409
Splice Capacity (Maximum) – Single Fusion (Thin, 80813123), Mass Fusion (Thin, 80813122), Mass Fusion (Deep, 80813121)	864, 3456 ¹ , 1728	576, 2304 ¹ , 1152
Number of Splice Trays – 80813123, 80813122 ¹ , 80813121	12, 12, 6	8, 8, 4
Cable Ports ²	7	7
Cable Diameters ³	0.093" – 1.38" (2.4 – 35.0 mm) and Flat Drop	0.093" – 1.38" (2.4 – 35.0 mm) and Flat Drop
Ground Studs	7	7
Configuration	Butt	Butt
Application	Direct Bury, Below Grade, Pole/Wall, Aerial	Direct Bury, Below Grade, Pole/Wall, Aerial
Ingress Protection	In accordance to Telcordia® GR-771-CORE, Buried, Underground; IP-68	In accordance to Telcordia® GR-771-CORE, Buried, Underground; IP-68
Size ⁴	13.3" W x 29.4" L (338 x 747 mm)	13.3" W x 29.4" L (338 x 747 mm)

¹ The 80813122 thin-profile splice tray can only be used for cables that contain SpiderWeb Ribbon (SWR®) – AFL, Rollable Ribbon (RR) – OFS, Pliable Ribbon – Sumitomo, or FlexRibbon™ – Prysmian

² Multi-hole grommets allow for more than one cable to enter each cable port.

³ Cables with diameters larger than 1.25" can only be used in end plate port numbers 3 and 6.

⁴ Outermost part of the assembly; includes the sealing collar.

COYOTE HD Dome Closure Kit Contents for Ribbon Applications

Catalog Number	Description
80061406	COYOTE HD Dome Closure for Ribbon – Includes (2) 1-Hole Grommets 0.85" - 1.00" (21.6 - 25.4 mm) and (2) 1-Hole Grommets 1.00" - 1.25" (25.4 - 31.8 mm)
80061407	COYOTE HD Dome Closure with Slack Basket for Ribbon – Includes (2) 1-Hole Grommets 0.85" - 1.00" (21.6 - 25.4 mm), (2) 1-Hole Grommets 1.00" - 1.25" (25.4 - 31.8 mm), and (1) 6-Pack, 36" long of 0.25" ID Transition Tubing
80061408	COYOTE HD Dome Closure for Ribbon – Includes (2) 1-Hole Grommets 1.00" - 1.25" (25.4 - 31.8 mm) and (2) 1-Hole Grommets 1.25" - 1.38" (31.8 - 35.0 mm)
80061409	COYOTE HD Dome Closure with Slack Basket for Ribbon – Includes (2) 1-Hole Grommets 1.00" - 1.25" (25.4 - 31.8 mm), (2) 1-Hole Grommets 1.25" - 1.38" (31.8 - 35.0 mm), and (1) 6-Pack, 36" long of 0.25" ID Transition Tubing

All kits include (1) COYOTE HD End Plate Organizer, (1) Dome, (1) Gasket, (1) Collar, (4) 1-Hole Grommets, (1) 12-Pack of 20" Long 0.50" ID Spiral Tubing, and Cable Restraint Hardware.

Telcordia® is a registered trademark of Telcordia Technologies, Inc. now part of Ericsson. SWR® is a registered trademark of AFL. FlexRibbon™ is a registered trademark of Prysmian.

▶ COYOTE® HD Dome Closure for Buffer Tube Applications

Specifications

Catalog Numbers	80061488
Splice Capacity (Maximum) – Single Fusion (Thin, 80813123, 72 ct.), Single Fusion (Thin, 80813301, 108 ct.)	576, 864
Number of Splice Trays – 80813123, 80813301	8, 8
Cable Ports ²	7
Cable Diameters	0.093" – 1.25" (2.4 – 31.8 mm) and Flat Drop
Ground Studs	7
Configuration	Butt
Application	Direct Bury, Below Grade, Pole/Wall, Aerial
Ingress Protection	In accordance to Telcordia® GR-771-CORE, Buried, Underground; IP-68
Size ⁴	13.3" W x 29.4" L (338 x 747 mm)

² Multi-hole grommets allow for more than one cable to enter each cable port.

⁴ Outermost part of the assembly; includes the sealing collar.

COYOTE HD Dome Closure Kit Contents for Buffer Tube Applications

Catalog Number	Description
80061488	COYOTE HD Dome Closure for Single Fusion – Includes (1) COYOTE HD End Plate Organizer, (1) Dome, (1) Gasket, (1) Collar, (2) 1-Hole Grommets 0.60" - 0.85" (15.2 - 21.6 mm), (2) 1-Hole Grommets 0.85" - 1.00" (21.6 - 25.4 mm) and Cable Restraint Hardware

Telcordia® is a registered trademark of Telcordia Technologies, Inc. now part of Ericsson.

▶ COYOTE® HD Dome Closure Tray Stacking for Buffer Tube Applications

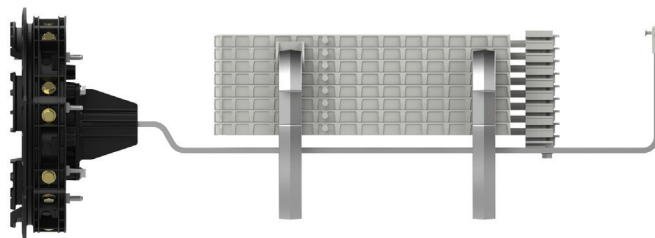

Catalog Number 80061488
with (8) 80813123 or 80813301 Splice Trays
Maximum Splice Capacity – 864 Ct.

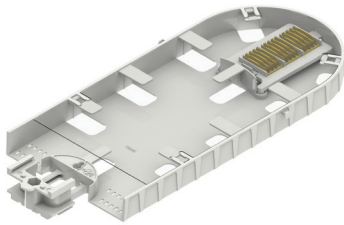

Catalog Number 80813121
Deep Profile Mass Fusion Flip Tray
288 ct.

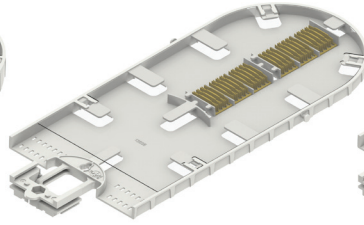

Catalog Number 80813122
Thin Profile Mass Fusion Flip Tray
288 ct.

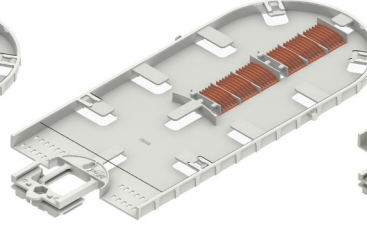

Catalog Number 80813123
Thin Profile Single Fusion Flip Tray
72 ct.

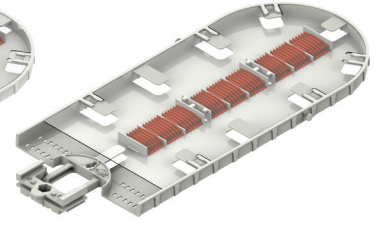

Catalog Number 80813301
Thin Profile Single Fusion Flip Tray
108 ct.

COYOTE HD Dome Closure Accessories

Catalog Number	Description
80813121	Deep Profile Mass Fusion Flip Tray, 288 CT.
80813122	Thin Profile Mass Fusion Flip Tray, 288 CT.
80813123	Thin Profile Single Fusion Flip Tray, 72 CT.
80813301	Thin Profile Single Fusion Flip Tray, 108 CT.
8004160	Heat Shrink Splice Protector Kit – Includes (50) 40 mm Mass Fusion
8004095	Heat Shrink Splice Protector Kit – Includes (50) 40 mm Single Fusion
8003717	Heat Shrink Splice Protector Kit – Includes (50) 60 mm Single Fusion
80813267	Deep Slack Basket Kit for up to 864 Expressed Mass Fusion Applications. For the COYOTE HD (High-Density) Dome Closure Only. This Slack Basket Kit should be ordered when a technician needs to store an excessive amount of slack. This Slack Basket is field installable to any COYOTE HD (High-Density) Dome for Ribbon Applications, but results in the ability to store (3) 80813121 Deep Profile Mass Fusion Flip Trays (288 CT. each) or (6) Thin Profile Mass Fusion or Single Fusion Flip Trays.
80061500	Breakout Kit for Unitube Ribbon Applications
COYEPFIX1	End Plate Fixture Assembly for 6.5" and 9.5" Domes
8003839	End Plate Kit for 9.5" Domes
80812608	End Plate Gasket for 9.5" Domes
80808528-1	Latching Collar for 9.5" Domes
80061201	Breakaway Bonding Plate for 9.5" Domes
80809205	Strength Member Bracket Kit – Includes (2) Short L-Brackets
800015236	Strength Member Bracket Kit – Includes (3) Long L-Brackets and (3) Hose Clamps
80808651	Strength Member Bracket Kit – Includes (4) Long L-Brackets
80813124	Splice Tray Locking Pin Kit – Includes (5) Tray Locking Pins
80813125	Splice Tray Tether Kit – Includes (6) Splice Tray Tether Straps
80812618	Pack of (4) 18" Long Pieces of 0.25" ID Tubing
80807991	100' Roll of 0.25" ID Tubing
80812881	100' Roll of 0.50" ID Spiral Wrap Tubing
8004154	125' Spool of Braided Expandable Sleeving, 3/8" Diameter, Blue
8004155	125' Spool of Braided Expandable Sleeving, 3/8" Diameter, Orange
8004156	125' Spool of Braided Expandable Sleeving, 3/8" Diameter, Green
8004157	125' Spool of Braided Expandable Sleeving, 3/8" Diameter, Brown
8004158	125' Spool of Braided Expandable Sleeving, 3/8" Diameter, Slate
8004159	125' Spool of Braided Expandable Sleeving, 3/8" Diameter, White
8004174	100' Spool of Split Braided Wrap, 3/8" Diameter, Blue
8004175	100' Spool of Split Braided Wrap, 3/8" Diameter, Orange

COYOTE HD Dome Closure Accessories (continued)

Catalog Number	Description
8004176	100' Spool of Split Braided Wrap, 3/8" Diameter, Green
8004177	100' Spool of Split Braided Wrap, 3/8" Diameter, Brown
8004178	100' Spool of Split Braided Wrap, 3/8" Diameter, Slate
8004167	100' Spool of Split Braided Wrap, 3/8" Diameter, White
8004168	100' Spool of Split Braided Wrap, 3/8" Diameter, Black
80813518	Wire Loom Insertion Tool - used for installing Split Braided Wrap
8003941	Swing Arm for Handhole Applications
8004003	Manhole Support Bracket

COYOTE HD Dome Closure Mounting Brackets

Catalog Number	Description
8003940	Aerial Mounting Bracket – Strand Applications
8004037	Aerial Adjustable Offset Mounting Bracket – Strand Applications
8003869	Aerial Mounting Bracket – ADSS Applications
8004038	Aerial Adjustable Offset Mounting Bracket – ADSS Applications
8003942	Pole/Wall Mounting Bracket
8003835	Universal Mounting Bracket – Handhole Applications
8003941	Swing Arm for Handhole Applications
8004003	Manhole Support Bracket

► Compatible with ribbon and loose tube cables including the following high-density fiber optic cables:

OFS AccuTube®+ Rollable Ribbon Fiber Optic Cable

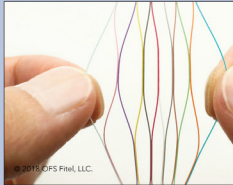
© 2018 OFS Fitel, LLC.

OFS AccuTube®+ Rollable Ribbon Fiber Optic Cable is a registered trademark of OFS Fitel, LLC.

Prysmian MassLink™ with FlexRibbon™ Technology



© 2018 Prysmian Group.

MassLink™ and FlexRibbon™ are registered trademarks of the Prysmian Group.

Corning RocketRibbon™ Extreme Density Cables



© 2018 Corning Incorporated.

RocketRibbon™ is a registered trademark of Corning Incorporated.