

COYOTE® DOME CLOSURES WITH UNIVERSAL ORGANIZERS

COYOTE Dome Closures with Universal Organizers are the most flexible splice closures that PLP has to offer. These closures incorporate the newly designed universal organizer system with PLP's patented segmented end plate and grommet sealing system. The universal organizer neatly manages and stores an assortment of buffer tube and ribbon fiber optic cable types and accepts the full line of COYOTE Legacy, LITE-GRIP®, and Flip Splice Trays. The segmented end plate and grommet sealing system allows for easy installation of a variety of cable sizes and provides a quick and easy way to access and remove cables to upgrade to a larger closure size when expanding the fiber optic network. These closures are truly adaptable to fit any splicing need.

FEATURES AND BENEFITS

- Eliminates the need to order and stock multiple versions of the same product
- Available dome closure sizes: COYOTE® ONE, 6.5" x 17", and 6.5" x 22"
- Organizer provides slack storage for any fiber optic cable type
- Organizer has molded in mounting platform to install COYOTE Flip Splice Trays
- Organizer can be converted with mounting posts to allow for installation of COYOTE Legacy and LITE-GRIP Splice Trays
- Segmented end plate design provides independent access to each cable port without disrupting surrounding cables
- Flexible grommet sealing technology supports a wide range of flat and round cable profiles
- Can be used for cross-connect applications
- Designed and tested in accordance to Telcordia® GR-771-CORE Buried, Underground, IP-68 Rated Requirements



PATENTED SEGMENTED END PLATES

- Allows independent access to each cable port without disrupting surrounding cables
- Cables are sealed within the end plate when the end plate caps compress against the COYOTE® Silicone Grommets
- Cable restraint hardware is designed to provide proper pull-out strength and restrict the strength member from pistoning inside the closure
- Attachment of cable restraint hardware to cables can occur outside of the dome's footprint prior to entry into the end plate
- Cable restraint hardware connects to the ground studs of the end plate and provides bonding or isolation for shielded cables

End Plate Design

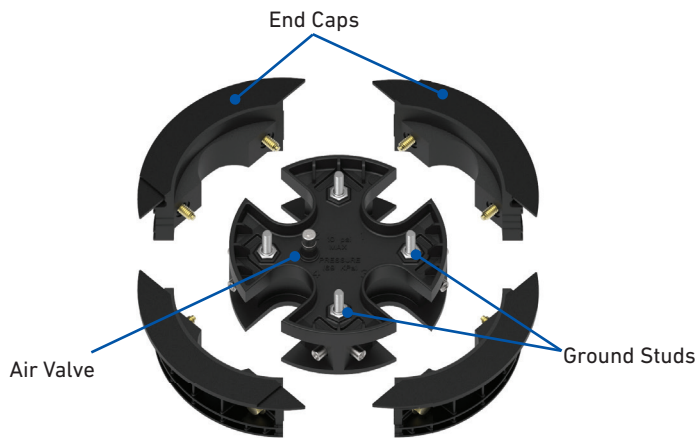

6.5" Dome Closure Patented Segmented End Plate

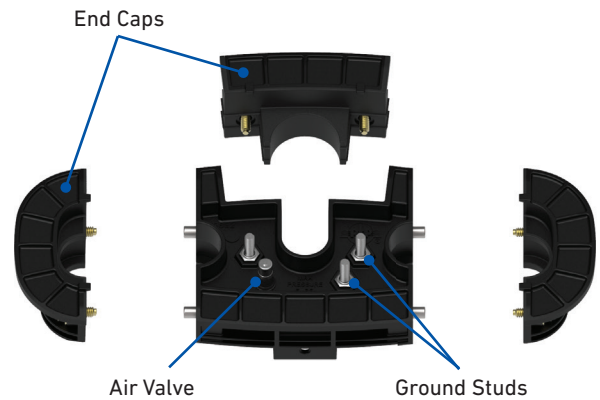

COYOTE® ONE Dome Closure Patented Segmented End Plate

Cable Restraint and Sealing System

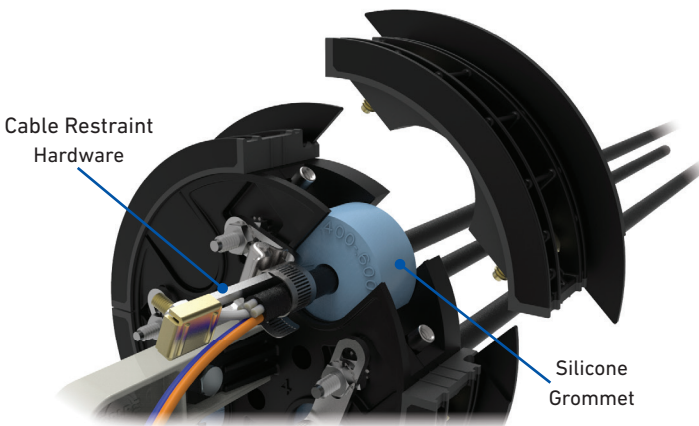

6.5" Dome End Plate Cap –
Exploded View

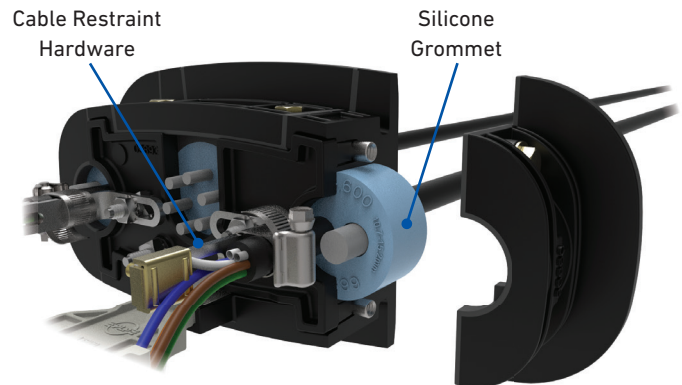

COYOTE ONE Dome End Plate Cap –
Exploded View

COYOTE® SILICONE GROMMETS

- Supports a wide range of round and flat cable profiles
- Eliminates the need for scuffing, adhesives, and sealing tapes
- Silicone grommets can be slit to allow installation of expressed cables
- Single and multi-hole versions available
- Multi-hole grommets allow multiple cables to enter a single end plate cable port
- Cable retention bobbins are available to help restrain cables installed in multi-hole grommets

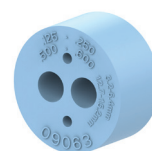
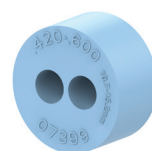
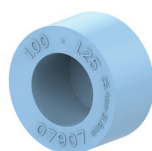
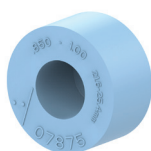
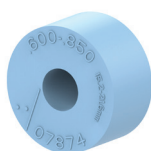
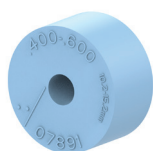

Catalog No: 8003691

0.40" - 0.60"
(10.2 mm - 15.2 mm)

8003692

0.60" - 0.85"
(15.2 mm - 21.6 mm)

8003693

0.85" - 1.00"
(21.6 mm - 25.4 mm)

8003694

1.00" - 1.25"
(25.4 mm - 31.8 mm)

8003663

0.42" - 0.60"
(10.7 mm - 15.2 mm)

8003990

0.50" - 0.60"
(12.7 mm - 15.2 mm)
0.125" - 0.250"
(3.2 mm - 6.4 mm)
and Flat Drop

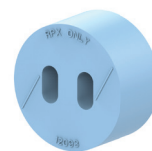
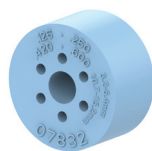
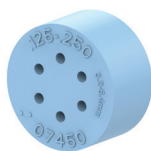
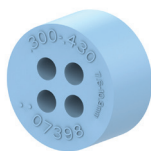
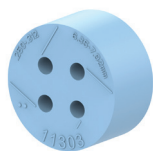

Catalog No: 8004065

0.250" - 0.312"
(6.4 mm - 7.9 mm)

8003664

0.30" - 0.43"
(7.6 mm - 10.9 mm)

8003665

0.125" - 0.250"
(3.2 mm - 6.4 mm)
and Flat Drop

8003676

0.42" - 0.60"
(10.7 mm - 15.2 mm)
0.125" - 0.250"
(3.2 mm - 6.4 mm)
and Flat Drop

8003677

0.125" - 0.250"
(3.2 mm - 6.4 mm)
and Flat Drop

8004122

RPX Only

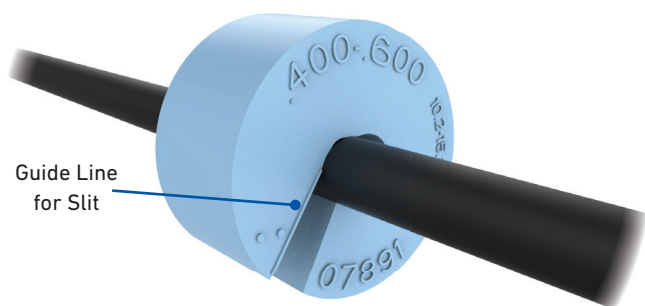

Installation of Slit Grommet on Cable

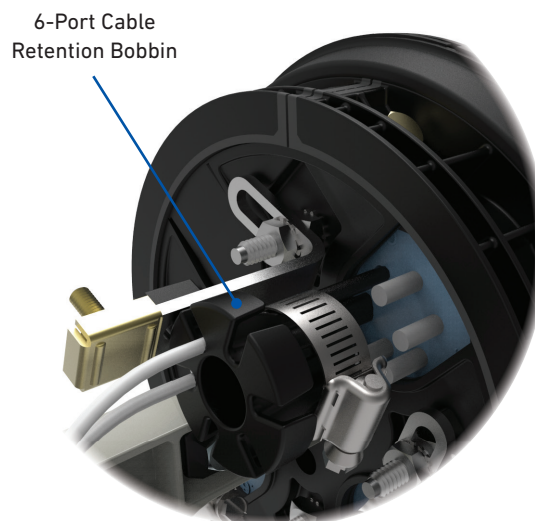

Installed 6-Port Cable Retention Bobbin for 6-Hole Grommet



UNIVERSAL ORGANIZERS

- One-piece design provides slack storage for any fiber optic cable type (buffer tube, ribbon, collapsible ribbon, microtube, etc.)
- Removable retention tabs
- Accommodates all COYOTE® splice tray types (Legacy, LITE-GRIP®, Flip Tray)
- Molded-in platform to secure COYOTE Flip Splice Trays
- Retention posts included for installation of COYOTE Legacy and LITE-GRIP splice trays within the organizer

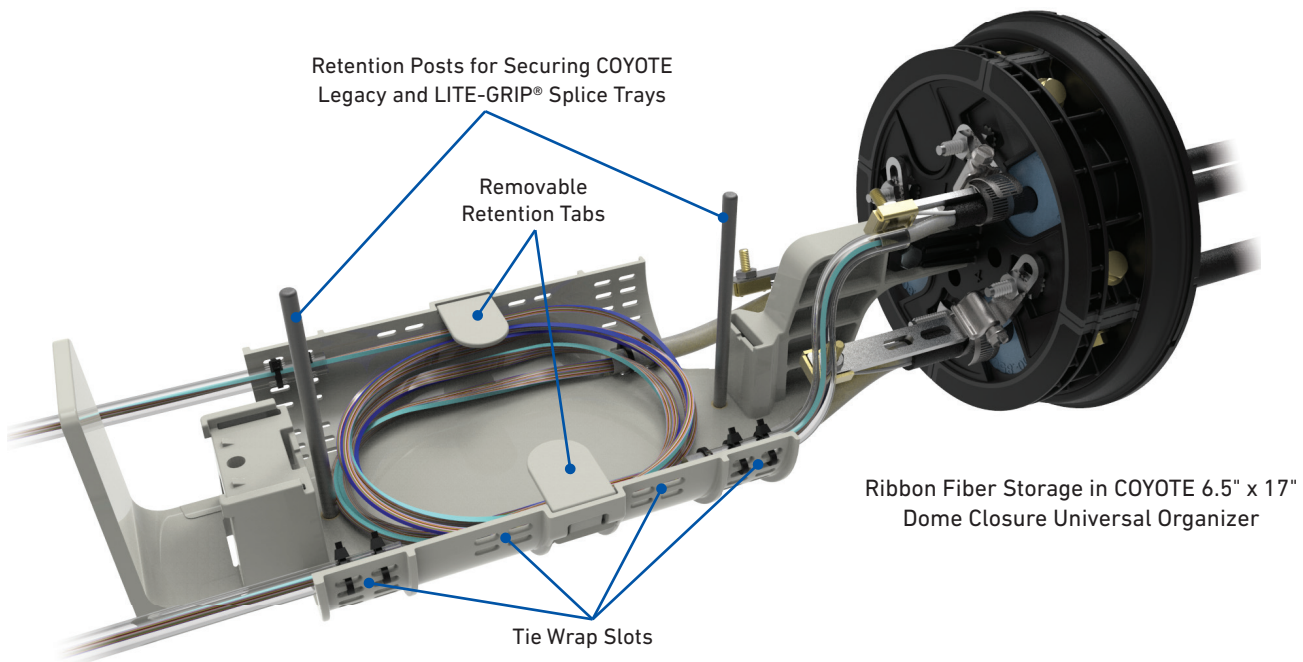
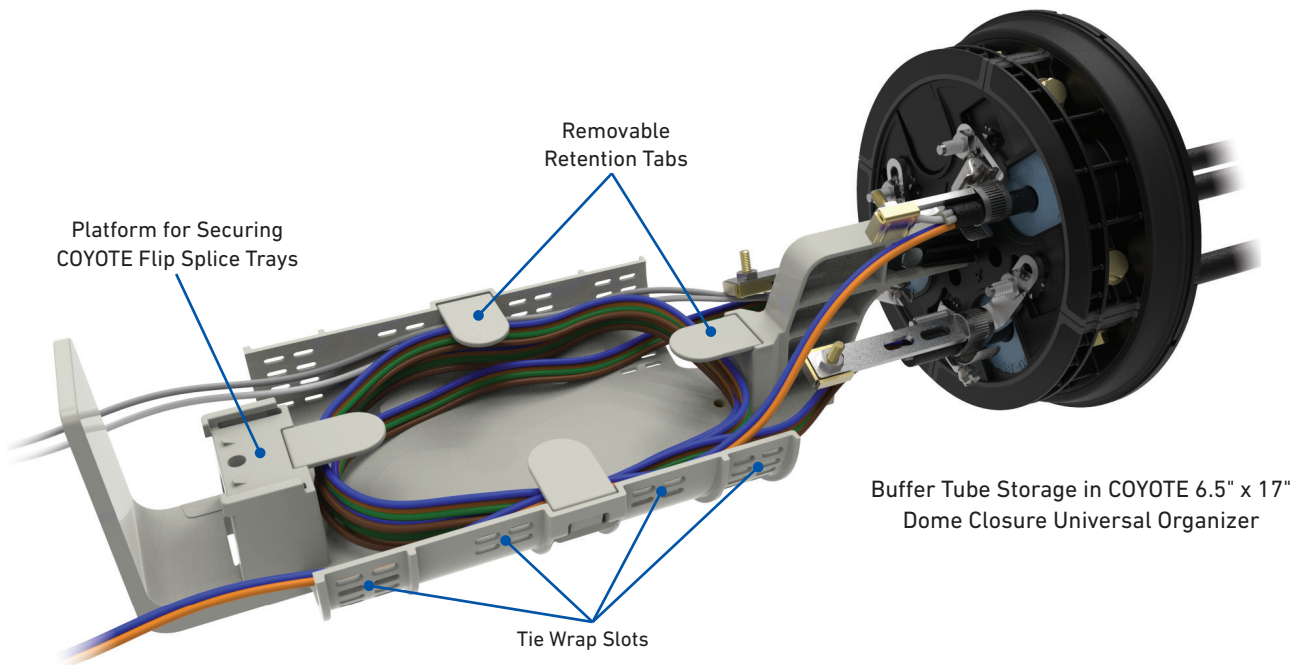

COYOTE® FLIP SPLICE TRAYS

- Modular design allows the splice trays to hinge upward to gain access to splice trays underneath the stack
- Slide lock prevents splice trays from rotating upward or downward when engaged
- Can be independently removed from the stack to allow multiple splicers to work simultaneously outside of the closure footprint
- Available in short and long versions
- Stores single fusion or mass fusion splices
- Hinge bracket attaches directly to COYOTE® Dome Closure Universal Organizers

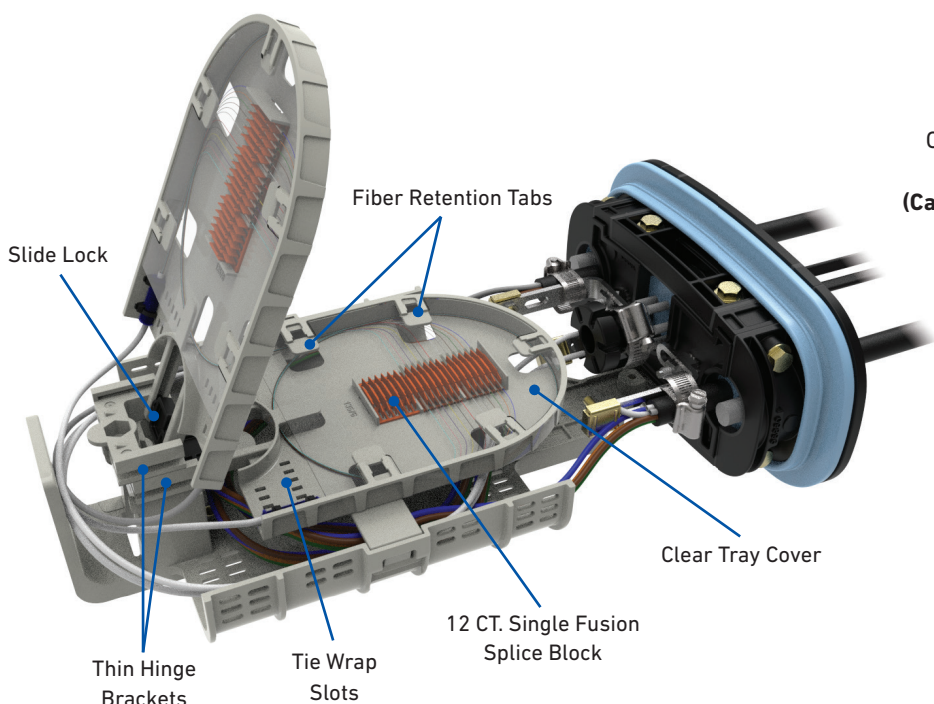

COYOTE Short Thin Profile 36 CT. Single Fusion /
144 CT. Mass Fusion Flip Splice Trays
(Catalog Number: 80814403) in COYOTE® ONE Dome
Closure Universal Organizer

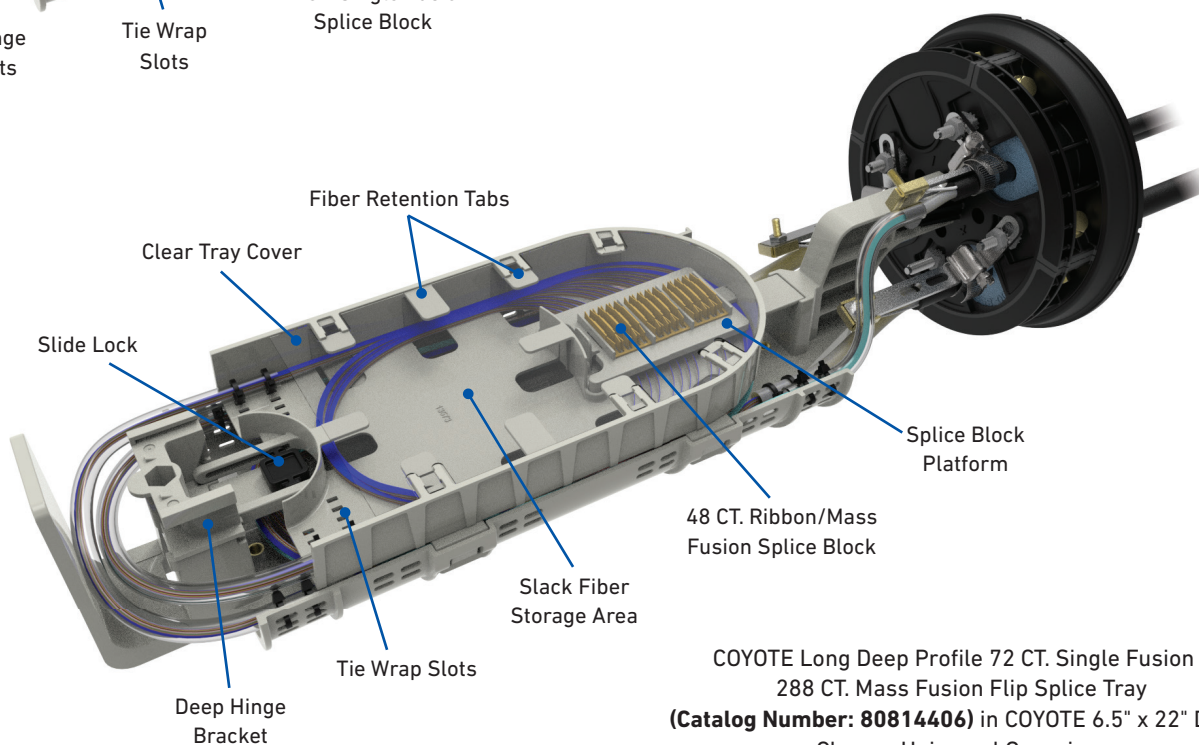

COYOTE Long Deep Profile 72 CT. Single Fusion /
288 CT. Mass Fusion Flip Splice Tray
(Catalog Number: 80814406) in COYOTE 6.5" x 22" Dome
Closure Universal Organizer



CROSS-CONNECT APPLICATIONS

- Cross-connect options available for COYOTE® 6.5" x 17" and 6.5" x 22" Dome Closures with Universal Organizer
- Ideal for applications where services need to be redirected often without having to re-splice each time
- Provides plug and play technology with industry standard connectors
- Closures are offered with either a COYOTE Flip Patch Tray or a bulkhead bracket
- COYOTE Flip Patch Tray and bulkhead bracket can be populated with a variety of adapter types and are compatible with bare fiber or pre-connectorized splitters

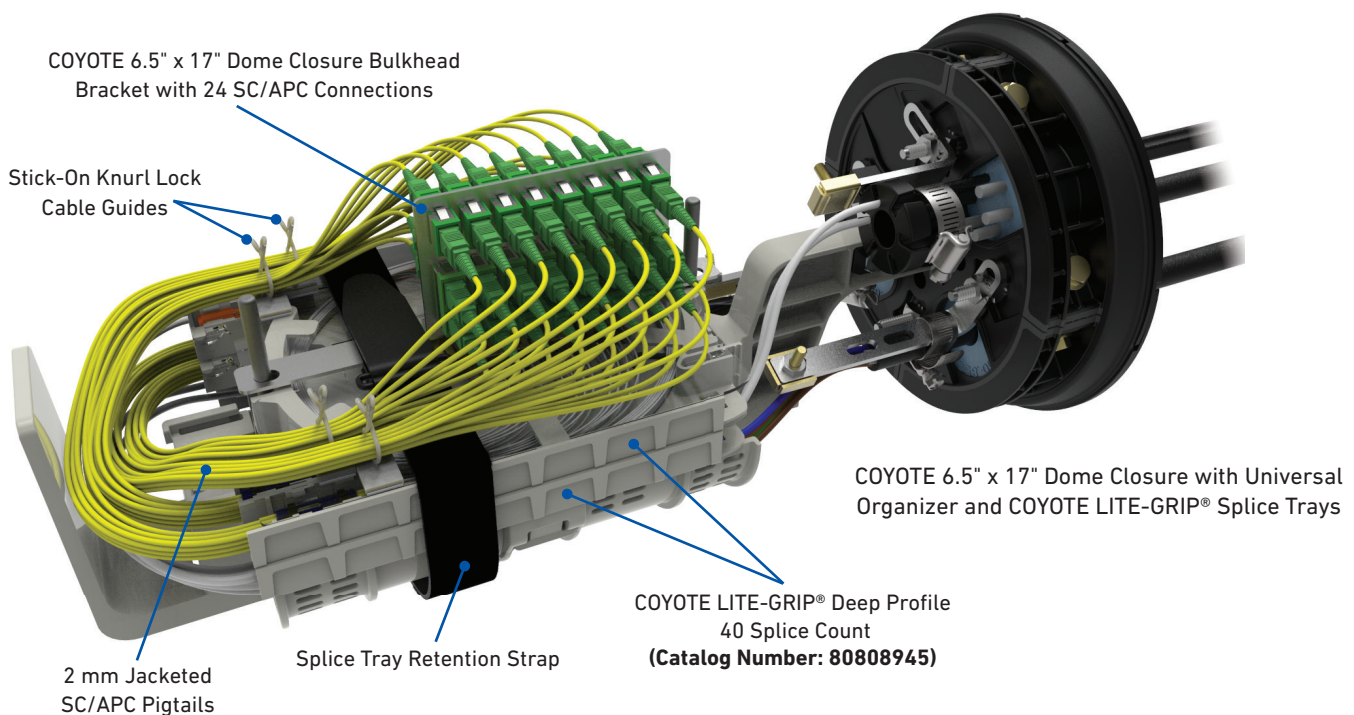
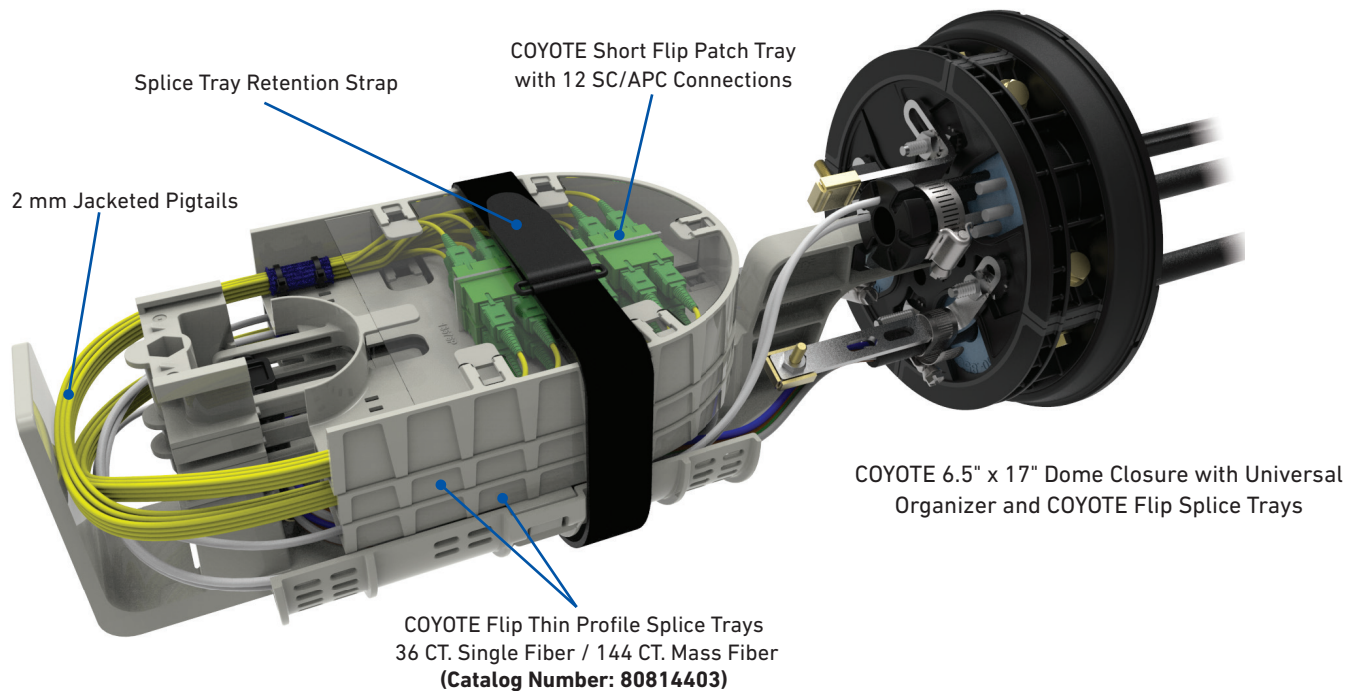

COYOTE® ONE DOME CLOSURE

Specifications

Catalog Number	COY1U-000
Splice Capacity (Maximum)	144 CT. Single Fusion ¹ , 288 CT. Ribbon/Mass Fusion ²
Number of Splice Trays (Maximum)	Legacy and LITE-GRIP® – (4) Low Profile, (3) Standard Profile, or (2) Deep Profile Flip – (2) Thin Profile or (1) Deep Profile
Cable Ports ³	3
Cable Diameters	0.093" – 0.85" (2.4 mm – 21.6 mm) and Flat Drop
Ground Studs	3
Configuration	Butt
Application	Direct Buried, Below Grade, Pole/Wall, Aerial
Ingress Protection	In accordance to Telcordia® GR-771-CORE, Buried, Underground; IP-68
Size	16.0" L x 10.8" W x 5.7" H (406 mm x 274 mm x 145 mm)

¹ Requires (4) LITE-GRIP Low Profile 36 CT. Splice Trays (**Catalog Number: 80813152**).

² Requires (2) LITE-GRIP Deep Profile 144 CT. Splice Trays (**Catalog Number: LGSTR144**).

³ Multi-hole grommets allow for more than one cable to enter each cable port.

COMPONENTS

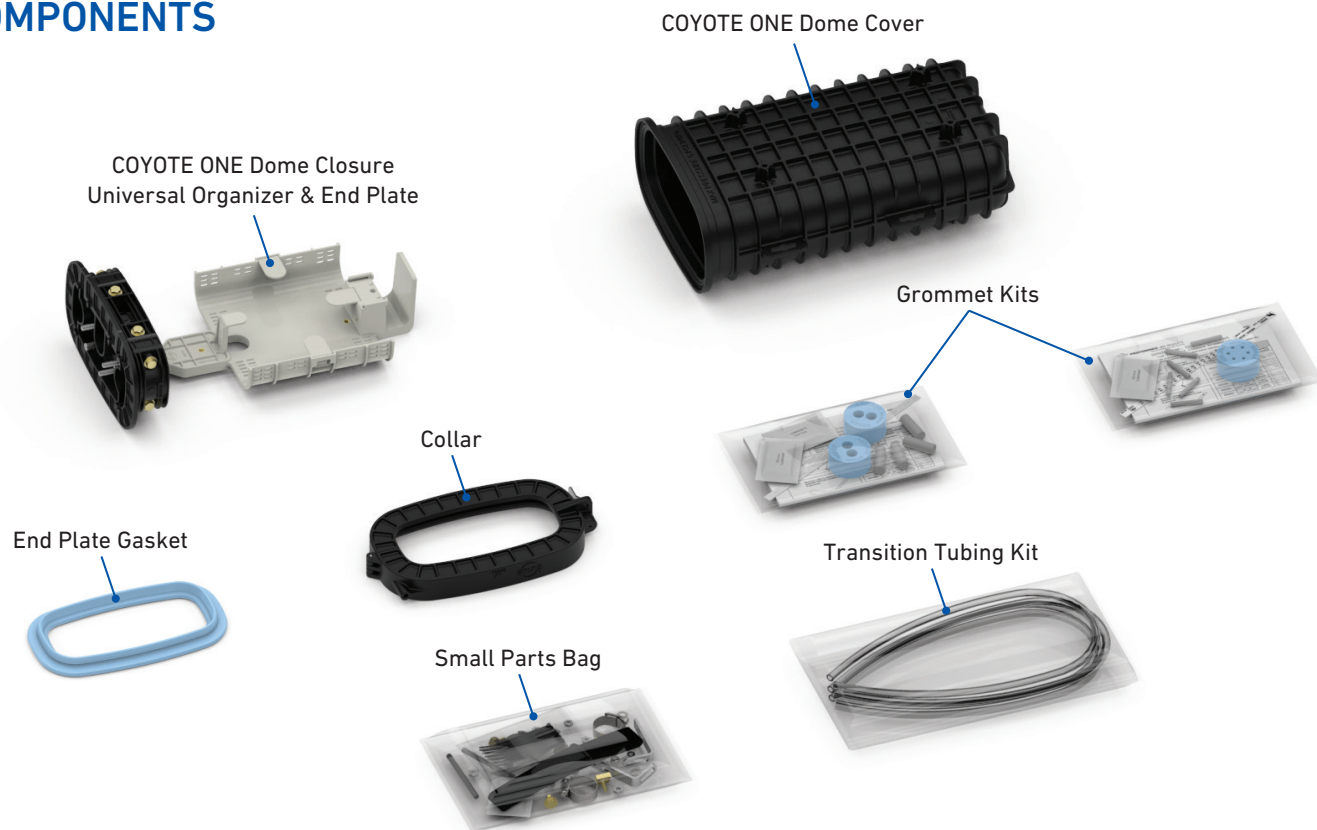

COYOTE ONE Dome Closure Kit with Universal Organizer

Catalog Number	Description
COY1U-000	COYOTE ONE with Universal Organizer – Includes (2) 2-Hole Grommets 0.42" – 0.60" (10.7 mm – 15.2 mm), (1) 6-Hole Grommet 0.125" – 0.250" (3.2 mm – 6.4 mm) & Flat Drop Cable, and (3) Cable Restraint Brackets with Associated Hardware

Kit also includes (1) COYOTE Segmented End Plate with Universal Organizer, (1) Dome, (1) Collar, (1) End Plate Gasket, (2) Splice Tray Retention Posts, and (1) Transition Tubing Kit. Splice Trays and Hanger Brackets are sold separately.

Telcordia® is a registered trademark of Telcordia Technologies, Inc., now part of Ericsson.



COYOTE® 6.5" x 17" DOME CLOSURE

Specifications

Catalog Number	COYD617U-000
Splice Capacity (Maximum)	216 CT. Single Fusion ¹ , 432 CT. Ribbon/Mass Fusion ²
Number of Splice Trays (Maximum)	Legacy and LITE-GRIP® – (6) Low Profile, (4) Standard Profile, or (3) Deep Profile Flip – (4) Thin Profile or (2) Deep Profile
Cable Ports ³	4
Cable Diameters	0.093" – 1.25" (2.4 mm – 31.8 mm) and Flat Drop
Ground Studs	4
Configuration	Butt
Application	Direct Buried, Below Grade, Pole/Wall, Aerial
Ingress Protection	In accordance to Telcordia® GR-771-CORE, Buried, Underground; IP-68
Size	8.6" Dia. x 17.9" L (218 mm x 455 mm)

¹ Requires (6) LITE-GRIP Low Profile 36 CT. Splice Trays (**Catalog Number: 80813152**).

² Requires (3) LITE-GRIP Deep Profile 144 CT. Splice Trays (**Catalog Number: LGSTR144**).

³ Multi-hole grommets allow for more than one cable to enter each cable port.

COMPONENTS



COYOTE 6.5" x 17" Dome Closure Kit with Universal Organizer

Catalog Number	Description
COYD617U-000	COYOTE 6.5" x 17" Dome Closure with Universal Organizer – Includes (2) 1-Hole Grommets 0.40" – 0.60" (10.2 mm – 15.2 mm), (2) 1-Hole Grommets 0.60" – 0.85" (15.2 mm – 21.6 mm), and (4) Cable Restraint Brackets with Associated Hardware

Kit also includes (1) COYOTE Segmented End Plate with Universal Organizer, (1) Dome, (1) Collar, (1) End Plate Gasket, (2) Splice Tray Retention Posts, and (1) Transition Tubing Kit. Splice Trays and Hanger Brackets are sold separately.

Telcordia® is a registered trademark of Telcordia Technologies, Inc., now part of Ericsson.

COYOTE® 6.5" x 17" CROSS-CONNECT DOME CLOSURE

Specifications

Catalog Number	CXD617U-002	CXD617U-003
Splice Tray Type	Flip	Legacy or LITE-GRIP®
Splice Capacity (Maximum)	72 CT. Single Fusion ¹ , 288 CT. Ribbon/Mass Fusion ¹	144 CT. Single Fusion ² , 288 CT. Ribbon/Mass Fusion ³
Number of Splice Trays (Maximum)	2 Thin Profile & 1 Flip Patch Tray or 1 Deep Profile & 1 Flip Patch Tray	(4) Low Profile, (3) Standard Profile, or (2) Deep Profile
Adapter Port Quantity (Maximum)	12 SC or 24 LC	24 SC or 48 LC
Cable Ports ⁴	4	
Cable Diameters	0.093" – 1.25" (2.4 mm – 31.8 mm) and Flat Drop	
Ground Studs	4	
Configuration	Butt	
Application	Direct Buried, Below Grade, Pole/Wall, Aerial	
Ingress Protection	In accordance to Telcordia® GR-771-CORE, Buried, Underground; IP-68	
Size	8.6" Dia. x 17.9" L (218 mm x 455 mm)	

¹ Requires (2) Flip Thin Profile 36/144 CT. Splice Trays (Catalog Number: 80814403)

² Requires (4) LITE-GRIP Low Profile 36 CT. Splice Trays (Catalog Number: 80813152).

³ Requires (2) LITE-GRIP Deep Profile 144 CT. Splice Trays (Catalog Number: LGSTR144).

⁴ Multi-hole grommets allow for more than one cable to enter each cable port.

CROSS-CONNECT COMPONENTS

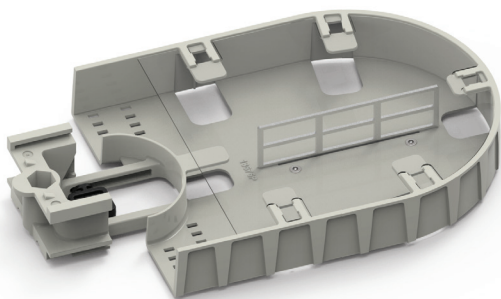

COYOTE Short Flip Patch Tray
Included with Catalog Number: CXD617U-002

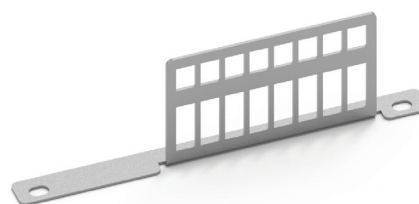

COYOTE Short 16 Position Bulkhead Bracket
Included with Catalog Number: CXD617U-003

COYOTE 6.5" x 17" Cross-Connect Dome Closure Kits with Universal Organizer

Catalog Number	Description
CXD617U-002	COYOTE 6.5" x 17" Cross-Connect Dome Closure with Universal Organizer – Includes (2) 1-Hole Grommets 0.40" – 0.60" (10.2 mm – 15.2 mm), (2) 1-Hole Grommets 0.60" – 0.85" (15.2 mm – 21.6 mm), (4) Cable Restraint Brackets with Associated Hardware, and (1) COYOTE Short Flip Patch Tray. NOTE: Adapters and pigtails sold separately. Compatible only with flangeless duplex SC or quad LC adapters
CXD617U-003	COYOTE 6.5" x 17" Cross-Connect Dome Closure with Universal Organizer – Includes (2) 1-Hole Grommets 0.40" – 0.60" (10.2 mm – 15.2 mm), (2) 1-Hole Grommets 0.60" – 0.85" (15.2 mm – 21.6 mm), (4) Cable Restraint Brackets with Associated Hardware, and (1) 16 Position Bulkhead Bracket. NOTE: Adapters and pigtails sold separately. Compatible with standard style adapters

Kit also includes (1) COYOTE Segmented End Plate with Universal Organizer, (1) Dome, (1) Collar, (1) End Plate Gasket, (2) Splice Tray Retention Posts, and (1) Transition Tubing Kit. Splice Trays and Hanger Brackets are sold separately.

Telcordia® is a registered trademark of Telcordia Technologies, Inc., now part of Ericsson.



COYOTE® 6.5" x 22" DOME CLOSURE

Specifications

Catalog Number	COYD622U-000
Splice Capacity (Maximum)	288 CT. Single Fusion ¹ , 648 CT. Ribbon/Mass Fusion ²
Number of Splice Trays (Maximum)	Legacy and LITE-GRIP® – (6) Low Profile, (4) Standard Profile, or (3) Deep Profile Flip – (4) Thin Profile or (2) Deep Profile
Cable Ports ³	4
Cable Diameters	0.093" – 1.25" (2.4 mm – 31.8 mm) and Flat Drop
Ground Studs	4
Configuration	Butt
Application	Direct Buried, Below Grade, Pole/Wall, Aerial
Ingress Protection	In accordance to Telcordia® GR-771-CORE, Buried, Underground; IP-68
Size	8.6" Dia. x 22.6" L (218 mm x 574 mm)

¹ Requires (4) Flip Thin Profile 72 CT. Splice Trays (**Catalog Number: 80814405**).

² Requires (3) LITE-GRIP Deep Profile 216 CT. Splice Trays (**Catalog Number: LGSTR216**).

³ Multi-hole grommets allow for more than one cable to enter each cable port.

COMPONENTS



COYOTE 6.5" x 22" Dome Closure Kit with Universal Organizer

Catalog Number	Description
COYD622U-000	COYOTE 6.5" x 22" Dome Closure with Universal Organizer – Includes (2) 1-Hole Grommets 0.40" – 0.60" (10.2 mm – 15.2 mm), (2) 1-Hole Grommets 0.60" – 0.85" (15.2 mm – 21.6 mm), and (4) Cable Restraint Brackets with Associated Hardware

Kit also includes (1) COYOTE Segmented End Plate with Universal Organizer, (1) Dome, (1) Collar, (1) End Plate Gasket, (2) Splice Tray Retention Posts, and (1) Transition Tubing Kit. Splice Trays and Hanger Brackets are sold separately.

Telcordia® is a registered trademark of Telcordia Technologies, Inc., now part of Ericsson.

COYOTE® 6.5" x 22" CROSS-CONNECT DOME CLOSURE

Specifications

Catalog Number	CXD622U-002	CXD622U-003
Splice Tray Type	Flip	Legacy or LITE-GRIP®
Splice Capacity (Maximum)	144 CT. Single Fusion ¹ , 288 CT. Ribbon/Mass Fusion ²	144 CT. Single Fusion ³ , 432 CT. Ribbon/Mass Fusion ⁴
Number of Splice Trays (Maximum)	2 Thin Profile & 1 Flip Patch Tray or 1 Deep Profile & 1 Flip Patch Tray	(4) Low Profile, (3) Standard Profile, or (2) Deep Profile
Adapter Port Quantity (Maximum)	24 SC or 48 LC	48 SC or 96 LC
Cable Ports ⁵	4	
Cable Diameters	0.093" – 1.25" (2.4 mm – 31.8 mm) and Flat Drop	
Ground Studs	4	
Configuration	Butt	
Application	Direct Buried, Below Grade, Pole/Wall, Aerial	
Ingress Protection	In accordance to Telcordia® GR-771-CORE, Buried, Underground; IP-68	
Size	8.6" Dia. x 22.6" L (218 mm x 574 mm)	

¹ Requires (2) Flip Thin Profile 72/144 CT. Splice Trays (Catalog Number: 80814405)

² Requires (2) Flip Thin Profile 72/144 CT. Splice Trays (Catalog Number: 80814405) or (1) Flip Deep Profile 72/288 CT. Splice Tray (Catalog Number: 80814406)

³ Requires (4) Legacy Low Profile 36 CT. Splice Trays (Catalog Number: 8001127) or (4) LITE-GRIP Low Profile 72/288 CT. Splice Trays (Catalog Number: 80810086) or (2) LITE-GRIP Deep Profile 72 CT. Splice Trays (Catalog Number: LGSTS72)

⁴ Requires (2) LITE-GRIP Deep Profile 216 CT. Splice Trays (Catalog Number: LGSTR216)

⁵ Multi-hole grommets allow for more than one cable to enter each cable port.

CROSS-CONNECT COMPONENTS

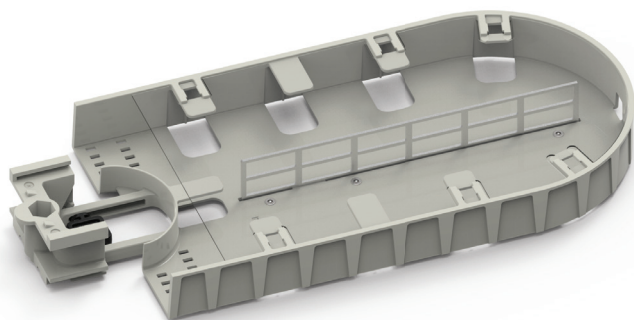

COYOTE Long Flip Patch Tray
Included with Catalog Number: CXD622U-002

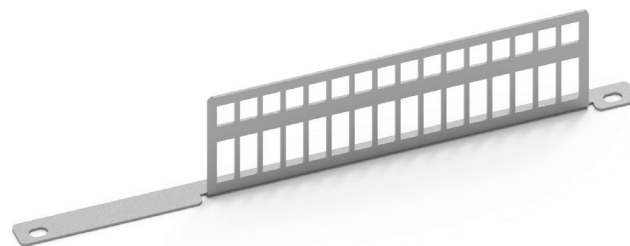

COYOTE Short 32-Position Bulkhead Bracket
Included with Catalog Number: CXD622U-003

COYOTE 6.5" x 22" Cross-Connect Dome Closure Kits with Universal Organizer

Catalog Number	Description
CXD622U-002	COYOTE 6.5" x 22" Cross-Connect Dome Closure with Universal Organizer – Includes (2) 1-Hole Grommets 0.40" – 0.60" (10.2 mm – 15.2 mm), (2) 1-Hole Grommets 0.60" – 0.85" (15.2 mm – 21.6 mm), (4) Cable Restraint Brackets with Associated Hardware, and (1) COYOTE Long Flip Patch Tray. NOTE: Adapters and pigtails sold separately. Compatible only with flangeless duplex SC or quad LC adapters
CXD622U-003	COYOTE 6.5" x 22" Cross-Connect Dome Closure with Universal Organizer – Includes (2) 1-Hole Grommets 0.40" – 0.60" (10.2 mm – 15.2 mm), (2) 1-Hole Grommets 0.60" – 0.85" (15.2 mm – 21.6 mm), (4) Cable Restraint Brackets with Associated Hardware, and (1) 32 Position Bulkhead Bracket. NOTE: Adapters and pigtails sold separately. Compatible with standard style adapters

Kit also includes (1) COYOTE Segmented End Plate with Universal Organizer, (1) Dome, (1) Collar, (1) End Plate Gasket, (2) Splice Tray Retention Posts, and (1) Transition Tubing Kit. Splice Trays and Hanger Brackets are sold separately.

Telcordia® is a registered trademark of Telcordia Technologies, Inc., now part of Ericsson.



COYOTE® SPLICE TRAYS







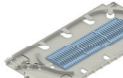

Short Splice Trays

Image	Description	COYOTE ONE	COYOTE 6.5" x 17" Dome
Single Fusion Splice Trays			
	Legacy Standard Profile (12 Splice Count) Cat. No. 80806033	3 Trays (36 CT.)	4 Trays (48 CT.)
	Legacy Low Profile (12 Splice Count) Cat. No. 80807701	4 Trays (48 CT.)	6 Trays (72 CT.)
	Flip Deep Profile (36 Splice Count) Cat. No. 80814404	1 Tray (36 CT.)	2 Trays (72 CT.)
	LITE-GRIP® Deep Profile (40 Splice Count) Cat. No. 80808945	2 Trays (80 CT.)	3 Trays (120 CT.)
	Flip Thin Profile (36 Splice Count) Cat. No. 80814403	2 Trays (72 CT.)	4 Trays (144 CT.)
	LITE-GRIP® Low Profile (24 Splice Count) Cat. No. 80809958	4 Trays (96 CT.)	6 Trays (144 CT.)
	LITE-GRIP® Low Profile (36 Splice Count) Cat. No. 80813152	4 Trays (144 CT.)	6 Trays (216 CT.)
Ribbon/Mass Fusion Splice Trays			
	Legacy Deep Profile (72 Splice Count) Cat. No. 80807114	2 Trays (144 CT.)	3 Trays (216 CT.)
	Flip Deep Profile (144 Splice Count) Cat. No. 80814404	1 Trays (144 CT.)	2 Trays (288 CT.)
	Flip Thin Profile (144 Splice Count) ¹ Cat. No. 80814403	2 Trays (288 CT.)	4 Trays (576 CT.)
	LITE-GRIP® Deep Profile (144 Splice Count) Cat. No. LGSTR144	2 Trays (288 CT.)	3 Trays (432 CT.)

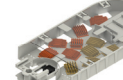
¹The 80814403 thin-profile flip tray can only be used for cables that contain SpiderWeb Ribbon (SWR®) – AFL, Rollable Ribbon (RR) – OFS, Pliable Ribbon – Sumitomo, or FlexRibbon™ – Prysmian.

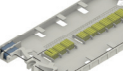
SWR® is a registered trademark of AFL. FlexRibbon™ is a trademark of Prysmian.

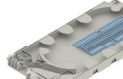
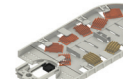
Long Splice Trays

Image	Description	COYOTE 6.5" x 22" Dome
Single Fusion Splice Trays		
	Legacy Standard Profile (36 Splice Count) Cat. No. 80805514	4 Trays (144 CT.)
	LITE-GRIP® Low Profile (36 Splice Count) Cat. No. 80810086	4 Trays (144 CT.)
	Flip Deep Profile (72 Splice Count) Cat. No. 80814406	2 Trays (144 CT.)
	Legacy Low Profile (36 Splice Count) Cat. No. 8001127	6 Trays (216 CT.)
	LITE-GRIP® Deep Profile (72 Splice Count) Cat. No. LGSTS72	3 Trays (216 CT.)
	Flip Thin Profile (72 Splice Count) Cat. No. 80814405	4 Trays (288 CT.)
Ribbon/Mass Fusion Splice Trays		
	Legacy Deep Profile (144 Splice Count) Cat. No. 80805515	3 Trays (432 CT.)
	Flip Thin Profile (144 Splice Count) ¹ Cat. No. 80814405	4 Trays (576 CT.)
	Flip Deep Profile (288 Splice Count) Cat. No. 80814406	2 Trays (576 CT.)
	LITE-GRIP® Deep Profile (216 Splice Count) Cat. No. LGSTR216	3 Trays (648 CT.)

¹The 80814405 thin-profile flip tray can only be used for cables that contain SpiderWeb Ribbon (SWR®) – AFL, Rollable Ribbon (RR) – OFS, Pliable Ribbon – Sumitomo, or FlexRibbon™ – Prysmian.

SWR® is a registered trademark of AFL. FlexRibbon™ is a trademark of Prysmian.

COYOTE® SPLICE TRAY ACCESSORIES



LITE-GRIP® 4 CT. Low Profile Splice Block for Single Fusion Splices (Black)

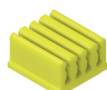

LITE-GRIP 8 CT. Splice Block for Single Fusion Splices (Yellow)



LITE-GRIP 36 CT. Splice Block for Ribbon/Mass Fusion Splices (Purple)

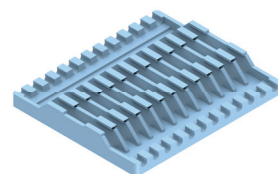

Elastomeric 12 CT. Splice Block for Single or Ribbon/Mass Fusion Splices (Light Blue)

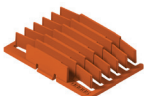

Plastic 12 CT. Splice Block for Single Fusion Splices (Orange)

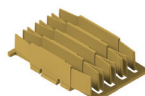

Plastic 48 CT. Splice Block for Ribbon/Mass Fusion Splices (Mustard)

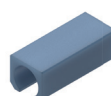

LITE-GRIP 1-Hole Retention Sleeve (Blue)



LITE-GRIP 1-Hole Retention Sleeve (Orange)

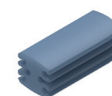

LITE-GRIP 6-Hole Retention Sleeve (Blue)



LITE-GRIP 6-Hole Retention Sleeve (Orange)

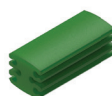

LITE-GRIP 6-Hole Retention Sleeve (Green)



40 mm Heat Shrink Splice Protector - Single Fusion



60 mm Heat Shrink Splice Protector - Single Fusion



40 mm Heat Shrink Splice Protector - Mass Fusion

COYOTE Splice Tray Accessory Kits

Catalog Number	Description
LGSBS4-5	Splice Block Kit – Includes (5) LITE-GRIP® Low Profile 4 CT. Single Fusion Splice Blocks, Black
LGSBS8-5	Splice Block Kit – Includes (5) LITE-GRIP 8 CT. Single Fusion Splice Blocks, Yellow
LGSBS8-50	Splice Block Kit – Includes (50) LITE-GRIP 8 CT. Single Fusion Splice Blocks, Yellow
LGSBR3-5	Splice Block Kit – Includes (5) LITE-GRIP 36 CT. Mass Fusion Splice Blocks, Purple
LGSBR3-50	Splice Block Kit – Includes (50) LITE-GRIP 36 CT. Mass Fusion Splice Blocks, Purple
8003381	Splice Block Kit – Includes (3) 12 CT. Elastomeric Single Fusion Splice Blocks, Light Blue
80813362	Splice Block Kit – Includes (6) 12 CT. Plastic Single Fusion Splice Blocks, Orange
8004153	Splice Block Kit – Includes (6) 48 CT. Plastic Single Fusion Splice Blocks, Mustard
LGRS1-25B	Retention Sleeve Kit – Includes (25) LITE-GRIP 1-Hole Retention Sleeve, Blue
LGRS1-25OR	Retention Sleeve Kit – Includes (25) LITE-GRIP 1-Hole Retention Sleeve, Orange
LGRS6-25B	Retention Sleeve Kit – Includes (25) LITE-GRIP 6-Hole Retention Sleeve, Blue
LGRS6-25OR	Retention Sleeve Kit – Includes (25) LITE-GRIP 6-Hole Retention Sleeve, Orange
LGRS6-25G	Retention Sleeve Kit – Includes (25) LITE-GRIP 6-Hole Retention Sleeve, Green
LGRSF2-25	Retention Sleeve Kit - Includes (25) 2-Slot Foam Microtube Retention Sleeve, Black
80808187	Heat Shrink Splice Protector Kit – Includes (12) 40 mm Single Fusion
8004095	Heat Shrink Splice Protector Kit – Includes (50) 40 mm Single Fusion
8003509	Heat Shrink Splice Protector Kit – Includes (12) 60 mm Single Fusion
8003717	Heat Shrink Splice Protector Kit – Includes (50) 60 mm Single Fusion
8003993	Heat Shrink Splice Protector Kit – Includes (12) 40 mm Mass Fusion
8004160	Heat Shrink Splice Protector Kit – Includes (50) 40 mm Mass Fusion
8003490	Felt Tape Kit – Includes (6) Buffer Tube Felt Strips
80808613	Express Fiber Storage Ring – For Deep Profile LITE-GRIP Splice Trays ONLY



COYOTE® TUBING AND SLEEVING KITS



Transport Tubing – 0.25" ID



Spiral Tubing – 0.50" ID

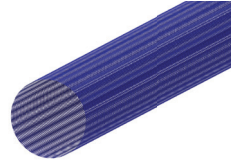

**Braided Expandable Sleeving –
3/8" Diameter**



**Split Braided Wrap –
3/8" Diameter**

COYOTE Tubing and Sleeving Kits

Catalog Number	Description
80805293	Tubing Kit – Includes (6) 0.135" ID x 35" Long Tubes
8003176	Tubing Kit – Includes (8) 0.135" ID x 35" Long Tubes
80806439	Tubing Kit – Includes (6) 0.170" ID x 35" Long Tubes
80812618	Tubing Kit – Includes (4) 0.25" ID x 25" Long Tubes
80813227	Tubing Kit – Includes (6) 0.25" ID x 36" Long Tubes
8003280	Tubing Kit – Includes (1) 0.135" ID x 25" Long Tube, (1) 0.170" ID x 25" Long Tube and (1) 0.25" ID x 25" Long Tube
80807989	100' Roll of 0.17" ID Tubing
80807991	100' Roll of 0.25" ID Tubing
80812881	100' Roll of 0.50" ID Spiral Wrap Tubing
8004231	200' Spool of Split Braided Wrap, 1/4" Diameter, White
8004232	200' Spool of Split Braided Wrap, 1/4" Diameter, Black
8004174	100' Spool of Split Braided Wrap, 3/8" Diameter, Blue
8004175	100' Spool of Split Braided Wrap, 3/8" Diameter, Orange
8004176	100' Spool of Split Braided Wrap, 3/8" Diameter, Green
8004177	100' Spool of Split Braided Wrap, 3/8" Diameter, Brown
8004178	100' Spool of Split Braided Wrap, 3/8" Diameter, Slate
8004167	100' Spool of Split Braided Wrap, 3/8" Diameter, White
8004168	100' Spool of Split Braided Wrap, 3/8" Diameter, Black
80813518	Wire Loom Insertion Tool for Split Braid Wrap
8004154	125' Spool of Braided Expandable Sleeving, 3/8" Diameter, Blue
8004155	125' Spool of Braided Expandable Sleeving, 3/8" Diameter, Orange
8004156	125' Spool of Braided Expandable Sleeving, 3/8" Diameter, Green
8004157	125' Spool of Braided Expandable Sleeving, 3/8" Diameter, Brown
8004158	125' Spool of Braided Expandable Sleeving, 3/8" Diameter, Slate
8004159	125' Spool of Braided Expandable Sleeving, 3/8" Diameter, White
8004206	125' Spool of Braided Expandable Sleeving, 3/8" Diameter, Red
8004207	125' Spool of Braided Expandable Sleeving, 3/8" Diameter, Black
8004044	125' Spool of Braided Expandable Sleeving, 3/8" Diameter, Yellow
8004208	125' Spool of Braided Expandable Sleeving, 3/8" Diameter, Violet
8004209	125' Spool of Braided Expandable Sleeving, 3/8" Diameter, Rose
8004210	125' Spool of Braided Expandable Sleeving, 3/8" Diameter, Aqua
80813680	Braided Expandable Sleeving Kit – Includes (6) 125' Spools of Braided Expandable Sleeving: Blue, Orange, Green, Brown, Slate, White
80813928	Braided Expandable Sleeving Kit – Includes (6) 125' Spools of Braided Expandable Sleeving: Red, Black, Yellow, Violet, Rose, Aqua
80813929	Braided Expandable Sleeving Kit – Includes (12) 125' Spools of Braided Expandable Sleeving: Blue, Orange, Green, Brown, Slate, White, Red, Black, Yellow, Violet, Rose, Aqua

CLOSURE ACCESSORIES AND MOUNTING BRACKETS

Accessory Kits for COYOTE® Dome Closures

Catalog Number	Description
80809205	Strength Member Bracket Kit – Includes (2) Short L-Brackets
80808651	Strength Member Bracket Kit – Includes (4) Long L-Brackets (For Use in 6.5" Dome Closures Only)
80808878	Large Strength Member Adapter Kit for Long Strength Member Brackets
80803989	Shield Connector
80811037	4-Port Cable Retention Bobbin Kit
80811036	6-Port Drop Cable Retention Bobbin Kit
80812928	6/8-Port Drop Cable Retention Bobbin Kit
80809894	End Plate Gasket for COYOTE ONE Dome Closure
80809897	Collar Assembly for COYOTE ONE Dome Closure
COYEPFIX1	End Plate Assembly Fixture for COYOTE 6.5" and 9.5" Dome Closures
80808997	End Plate Gasket for COYOTE 6.5" Dome Closures
80807332	Latching Collar for COYOTE 6.5" Dome Closures
80061200	Breakaway Bonding Plate for 6.5" Dome Closures

Mounting Bracket Kits for COYOTE® ONE Dome Closure

Catalog Number	Description
EVOBKT-ALC	Aerial Low Clearance Mounting Bracket – Strand Applications
8004031	Aerial Low Clearance Mounting Bracket – ADSS Applications
EVOBKT-AE	Aerial Adjustable Offset Mounting Bracket – Strand Applications
8004032	Aerial Adjustable Offset Mounting Bracket – ADSS Applications
EVOBKT-PWM	Pole/Wall Mounting Bracket
8003835	Universal Mounting Bracket – Handhole Applications
8004003	Manhole Support Bracket

Mounting Bracket Kits for COYOTE® 6.5" Dome Closures

Catalog Number	Description
8003831	Aerial Mounting Bracket – Strand Applications
8004035	Aerial Adjustable Offset Mounting Bracket – Strand Applications
8003833	Aerial Mounting Bracket – ADSS Applications
8004036	Aerial Adjustable Offset Mounting Bracket – ADSS Applications
8003702	Pole/Wall Mounting Bracket
8003835	Universal Mounting Bracket – Handhole Applications
8003707	Swing Arm for Handhole Applications
8004003	Manhole Support Bracket



COYOTE® CROSS-CONNECT ACCESSORIES



SC/APC Simplex Adapter

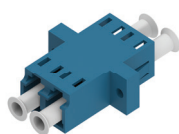

LC/UPC Duplex Adapter



SC/APC Duplex Adapter

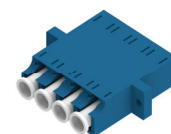

LC/UPC Quad Adapter



SC/APC Duplex Flangeless Adapter

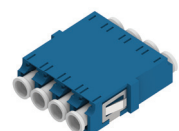

LC/UPC Quad Flangeless Adapter

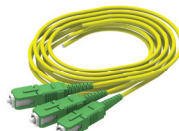

3-Pack of 2 mm Jacketed SC/APC Pigtails with Short Boot Connectors



4-Pack of 2 mm Jacketed LC/UPC Pigtails with Short Boot Connectors

COYOTE 6.5" Cross-Connect Dome Closure Accessories

Catalog Number	Description
80813593	Adapter Kit – Includes (8) SC/APC Simplex Adapters
80813594	Adapter Kit – Includes (8) SC/UPC Simplex Adapters
80813595	Adapter Kit – Includes (8) SC/APC Duplex Adapters
80813596	Adapter Kit – Includes (8) SC/UPC Duplex Adapters
80813597	Adapter Kit – Includes (8) LC/APC Duplex Adapters
80813598	Adapter Kit – Includes (8) LC/UPC Duplex Adapters
80813599	Adapter Kit – Includes (8) LC/APC Quad Adapters
80813600	Adapter Kit – Includes (8) LC/UPC Quad Adapters
80813988	Flangeless Adapter Kit – Includes (6) SC/APC Duplex Flangeless Adapters
80813989	Flangeless Adapter Kit – Includes (6) SC/UPC Duplex Flangeless Adapters
80813990	Flangeless Adapter Kit – Includes (6) LC/APC Quad Flangeless Adapters
80813991	Flangeless Adapter Kit – Includes (6) LC/UPC Quad Flangeless Adapters
COYTRM-2PK-SCA-SB	Pigtail Kit – Includes (2) SC/APC 2 mm Jacketed Pigtails with Short Boot Connectors
COYTRM-2PK-SCU-SB	Pigtail Kit – Includes (2) SC/UPC 2 mm Jacketed Pigtails with Short Boot Connectors
COYTRM-3PK-SCA-SB	Pigtail Kit – Includes (3) SC/APC 2 mm Jacketed Pigtails with Short Boot Connectors
COYTRM-3PK-SCU-SB	Pigtail Kit – Includes (3) SC/UPC 2 mm Jacketed Pigtails with Short Boot Connectors
COYTRM-4PK-SCA-SB	Pigtail Kit – Includes (4) SC/APC 2 mm Jacketed Pigtails with Short Boot Connectors
COYTRM-4PK-SCU-SB	Pigtail Kit – Includes (4) SC/UPC 2 mm Jacketed Pigtails with Short Boot Connectors
COYTRM-4PK-LCA-SB	Pigtail Kit – Includes (4) LC/APC 2 mm Jacketed Pigtails with Short Boot Connectors
COYTRM-4PK-LCU-SB	Pigtail Kit – Includes (4) LC/UPC 2 mm Jacketed Pigtails with Short Boot Connectors



GLOBAL HEADQUARTERS 660 BETA DRIVE CLEVELAND, OHIO 44143
+1 440 461 5200 INFO@PLP.COM PLP.COM

©2022 Preformed Line Products Printed in U.S.A. CO-SS-1318-1 10.22.00