



PREFORMED LINE PRODUCTS
The connection you can count on.

TRANSMISSION LINE REPAIR MANUAL

A guidebook for the inspection and
repair of damaged or worn conductors



 COMMUNICATIONS  ENERGY  SPECIAL INDUSTRIES  SOLAR

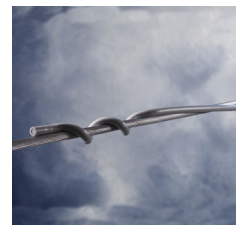

August 2017

PREFACE

Since 1947 Preformed Line Products has been a recognized leader in the business of safeguarding transmission line conductors. Many of the innovative ideas and solutions developed by PLP over the years can be applied to the repair and restoration of existing transmission lines today.

This manual describes the causes of conductor and shield wire damage, the types of common damage and failures, the inspection and assessment of damage, recommendations for the restoration of the conductor and finally, preventative measures to avert future damage.



ARMOR-GRIP® Suspension (1951)



Spiral Vibration Damper (1960)



CUSHION-GRIP® Suspension (2002)



VORTX™ Damper (2005)



Air Flow Spoiler (1983)

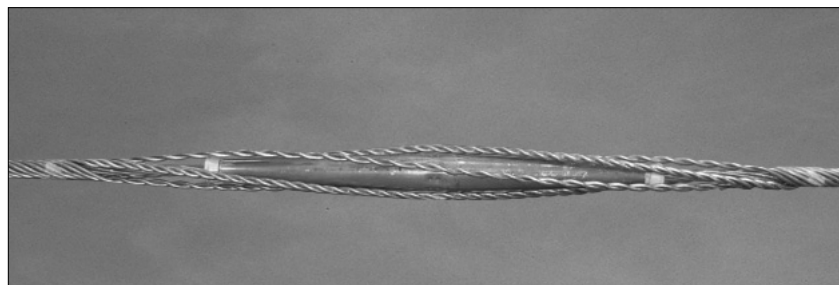

Splice Shunt (1950's)



Detuning Pendulum (2013)

CONTENTS

I. CAUSES AND TYPES OF CONDUCTOR DAMAGE

Aeolian Vibration	2
Galloping	3
Wake Induced Oscillation	4
Other	5

II. ASSESSMENT OF CONDUCTOR DAMAGE

Visual Inspection	6
X-Ray Inspection	6
Acoustical Inspection	7

III. ASSESSMENT OF COMPRESSION SPLICES

General	7
Resistance Ratio	7
Infrared Inspection (IR)	7
Acoustical Inspection	7

IV. RESTORATION AND PREVENTATIVE MEASURES

General	8
Conductors	8
Overhead Shield Wire (OHSW)	11
Optical Ground Wire (OPGW)	11
Compression Splices	11

V. APPENDIX “A” – Catalog Information

Line Guards	15
Armor Rods	19
Conductor Splices	27
ACSR Full Tension Splice	41
THERMOLIGN® Splice	44
Splice/Dead-end Shunt	46
CUSHION-GRIP® Suspension	48
Overhead Shield Wire Repair Rods (OHSW)	52
Optical Ground Wire Repair Rods (OPGW)	53

I. CAUSES AND TYPES OF CONDUCTOR DAMAGE

AEOLIAN VIBRATION

Aeolian vibration of transmission conductors is a common occurrence, created by smooth (laminar) winds (5 to 15 mph) blowing across the conductor surface. The resultant standing wave vibrations are generally less than a conductor diameter in amplitude, with a frequency of 10 to 50 hertz for conductors and 40 to 130 hertz for overhead shield wires (OHSW) and optical ground wires (OPGW). The severity and duration of aeolian vibration are a function of the conductor tension, terrain and prevailing wind direction (high tension with open terrain and winds perpendicular to the line being the worst).

The aeolian vibration activity in a span creates dynamic bending stresses on the conductor at the structure support hardware at each end of the span, and at the dampers, spacers or spacer dampers within the span.

When the vibration activity and the associated bending stresses are severe enough, the aluminum strands of a conductor will crack and then break (fatigue failure) at some point in time. All materials, including aluminum conductor strands, have an “endurance limit” to bending. Below the endurance limit, the bending stresses are low enough that they cause no weakening or damage (fatigue). When the endurance limit is exceeded, there is a weakening of the material (aluminum conductor strand) for each cycle of bending. The weakening continues until a critical number of cycles is reached, and a crack is produced. The number of bending cycles required to produce a crack is directly related to how much the actual bending stresses exceed the endurance limit.

The conductors of a transmission line may experience vibration-related bending stresses below the endurance limit during warmer months when the tensions are lower, but could exceed the endurance limit during the winter when line tensions are increased due to colder temperatures. The weakening associated with bending stresses above the endurance limit is cumulative and typically after a number of years, cracking and breaking of conductor strands begin to appear.

The bending stresses on conductor strands at the support structures are greatly influenced by the type of suspension hardware used.

Bolted suspension clamps, even when applied over Armor Rods, produce a considerable amount of compression on the conductor as it is squeezed between the body and keeper of the clamp. The compression causes the aluminum strands of each layer to press against each other, and against the strands of the core. Since each layer in a conductor is wound in the opposite direction, the compression produces notches in the strands, as shown in this photo. These notches actually reduce the diameter of the strand, producing stress risers and lowering the endurance limit.



Another effect of the strand notching is related to the actual location where cracking of the strands will initiate. Since the strands in the second layer become notched on both the top and bottom surfaces, the reduction in the endurance limit is greater than for the outer layer. It is for this reason that strand fatigue failures often occur in the underlying layers of a conductor within a bolted suspension clamp, even if the outer layer is intact.

Suspension assemblies, such as the ARMOR-GRIP® Suspension and the CUSHION-GRIP® Suspension that surround the conductor with an elastomer insert, do not produce compressive loads on the conductor sufficient enough to cause notching, thus retaining the original endurance limit. Furthermore, the elastomer insert absorbs a significant amount (40% to 50%) of the bending stresses that the conductor would be exposed to, compared to a bolted clamp under the same vibration activity.



Aeolian vibration activity can also cause the loosening of keepers in bolted suspension clamps, and loosening of the attachment clamps of dampers, spacers and spacer dampers. When a keeper or a clamp loosens enough, the conductor will move back and forth, causing abrasion to the outer aluminum strands. Continued activity of the conductor surface loosens the connection further and accelerates the abrasion, often wearing completely through the outer strands.

GALLOPING

Galloping of transmission lines is generally associated with moderate to high winds (15 to 40 mph) blowing over ice-covered conductors. The resulting motion is generally very dramatic, with peak-to-peak amplitudes as high or higher than the mid-span sag. The frequency of this motion is generally about 2 hertz (for single loop galloping).

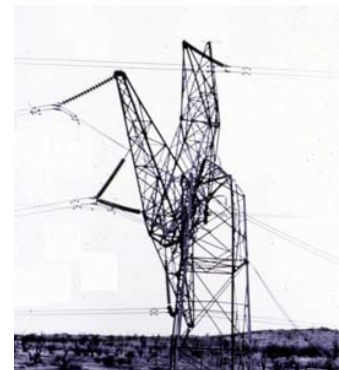

With the severe amplitudes associated with galloping, the bending stresses produced on the conductors at support structure hardware are extremely high. Therefore, the fatigue of conductor strands can occur in a short period of time compared to fatigue created by aeolian vibration.

Conductor strands that have experienced fatigue failures due to galloping appear to the naked eye to be the same as strands that have failed from aeolian vibration; however, under an electron microscope it is possible to see the difference because the higher stresses associated with galloping cause the cracking of the material to progress at a much faster rate.

Galloping of transmission lines can cause the weights on stockbridge type vibration dampers to fall off. This is generally due to a fatigue failure of the messenger strand. The result is that for future aeolian vibration activity, the conductor will not have the benefit of the dampers, and bending stresses will increase at the support hardware.

WAKE-INDUCED OSCILLATIONS

Wake-induced oscillations are associated with bundled conductor configurations (twin, tri, quad, etc.), and are created by one of the sub-conductors of the bundle lying in the “wake” of another sub-conductor. The wake created by winds (10 to 40 mph) passing over the sub-conductors will create motions of the sub-spans between spacer or spacer dampers (breathing), or of the entire span (vertical galloping, snaking or rolling), as illustrated below.

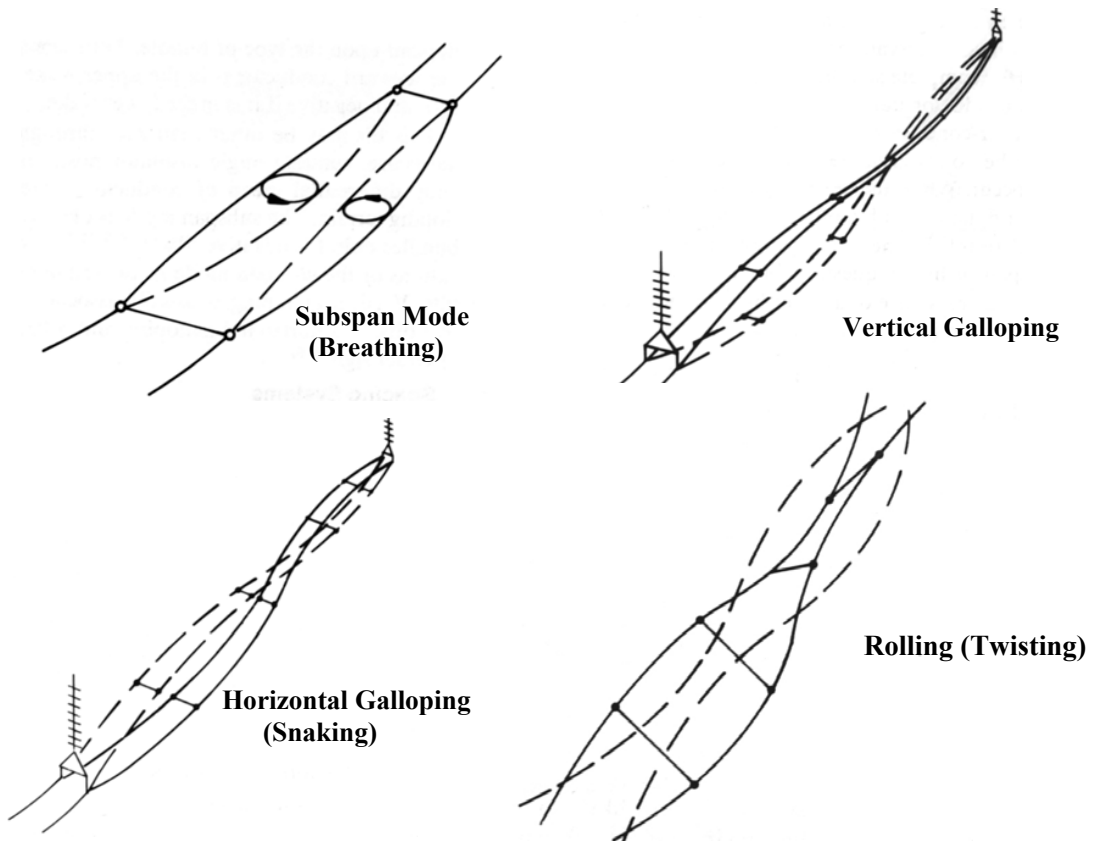

The sub-span or breathing mode produces a variety of forces and torque on the clamps of spacers and spacer dampers. Clamps that have loosened or relaxed over time due to aeolian vibration or other factors allow the conductor to move or twist within the clamp. This movement will cause abrasion of the conductor over time.

The rolling or twisting modes of the entire span also produce torque and forces on the clamps of spacers and spacer dampers that could lead to slipping and abrasion.



It is also possible for the forces associated with the various wake-induced oscillation motions to cause excessive wear of the damping elements (generally an elastomer material) of spacer dampers, rendering them ineffective against aeolian vibration.

OTHER CAUSES OF CONDUCTOR DAMAGE

In addition to possible damage from aeolian vibration, galloping or wake-induced oscillation (bundled configurations), transmission line conductors may be damaged by lightning strikes or flashover, direct contact, or by firearms.

The energy from a direct lightning strike or from a flashover can melt a portion of a conductor.

A bullet hitting a conductor can severely damage the aluminum strands.

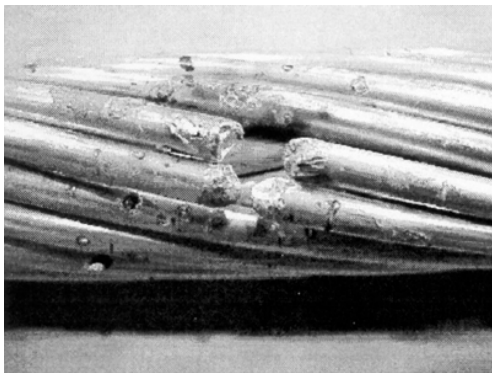

Damage from lightning



Damage from firearms

II. ASSESSMENT OF CONDUCTOR DAMAGE

VISUAL INSPECTION

Since conductor damage is often hidden beneath Armor Rods or beneath the outer strands, worthwhile visual inspections require that the suspension hardware and Armor Rods, if present, be removed. It is also necessary to relieve the line tension on the conductor at the support during a visual inspection for at least two reasons. First, and most importantly is that the Armor Rods may be carrying the load of underlying broken strands. Removal of the Armor Rods without relieving the tension could result in overloading and possible failure of the damaged conductor beneath the rods.

The second reason to relieve the tension is so that the underlying strands of the conductor can be inspected. As stated earlier, it is not uncommon for breaks to occur in the inner layer first (under bolted clamps).

During any inspection, it is important to determine the exact number of strands (aluminum and core) that have cracked or failed. Different repair products are used for different levels of damage (as will be seen later in this document).

Aeolian vibration and galloping activity often leave telltale signs on suspension hardware that can be seen even during flying inspections of the line. Aeolian vibration, even at moderate levels, can cause the stainless steel cotter key in a pin to leave a clear impression in the softer aluminum housing of a clamp.



With galloping, the forces are so severe that the material will wear at the mating surfaces between Y clevis units and yoke plates. The high loads and hammering action of the galloping literally cause the materials to be pushed aside.

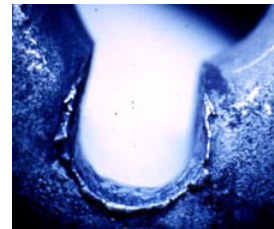

X-RAY INSPECTION

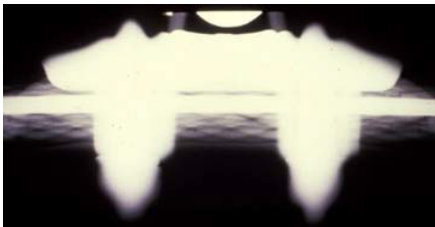

Throughout the years, X-ray inspections have been used to assess the condition of conductors without removing the suspension clamp (only possible with aluminum-based suspension clamps). Specialized field X-ray equipment is positioned around the suspension clamp, and an image of the conductor within is obtained. Close inspection by an experienced technician will show cracked or broken strands.

ACOUSTICAL INSPECTION

A new technology has been developed by EPRI Solutions that uses an acoustical signal to perform a hot-line evaluation of conductors without the need to remove suspension hardware. The device injects an acoustical signal in the conductor near the suspension point and captures the return signal. The return signal is compared to a signal from an undamaged conductor of the same size and construction. The comparison of the signals can reveal broken strands and the level of corrosion of the core.

This new technology is commercially available and provides the industry with a much-needed evaluation tool.

III. ASSESSMENT OF COMPRESSION SPLICES

GENERAL

Historically, due to material aging, improper installation, or problems with inhibiting compounds, a certain percent of compression splices become ineffective to the point where a failure is possible. For these reasons, compression splices on transmission lines are generally evaluated on a routine basis.

A number of techniques have been developed, or are being developed, to assess the conditions of splices on operating lines. Among these are the following.

RESISTANCE RATIO: OHMSTIK™

With this device, the electrical resistance across the splice is measured and compared (as a ratio) to that of a new splice of the same type. The value of the ratio determines the course of action to be taken; none (the splice is like new), continue monitoring over time (some level of deterioration has occurred), or replace or shunt (failure is imminent).

INFRARED INSPECTION (IR)

There have been continued advancements in infrared inspection equipment that allows the temperature of a splice to be measured from the ground or from an aircraft. As long as the splice is cooler than the adjacent conductor, there is no indication of problems. A splice that is operating at a temperature higher than the conductor should be replaced or shunted.

ACOUSTICAL INSPECTION

EPRI Solutions plans to investigate whether or not the acoustical inspection equipment that they have developed for the evaluation of conductors will reveal relevant information on the condition of a compression splice.

IV. RESTORATION AND PREVENTATIVE MEASURES

GENERAL

Once the extent of the damage is determined, the next steps are to restore the mechanical and electrical integrity of the system, and to initiate preventative measures to prevent a similar occurrence in the future.

As you will see in the following sections, there are different repair products for different degrees of damage. ***Therefore, it is important to be thorough in the assessment of the damage. If there is some uncertainty as to the degree of the damage, it is always prudent to assume the worst case.***

CONDUCTORS

Line Guards & Armor Rods

For partially damaged conductors, Line Guards and Armor Rods can be used to restore 100% of the mechanical and electrical integrity of a damaged conductor (within the span or at the support points). The table below shows the number of damaged aluminum strands that can be repaired on typical conductors with Line Guards and Armor Rods. See Appendix A for catalog sheets for common Line Guards and Armor Rods.

Notes: The broken or cracked aluminum strands can be in any layer of the conductor.

For ACSR and ACSS conductors, the steel core must be intact.

	ACSR & ACSS							AAC				AAAC	
	6/1	18/1	24/7	26/7	30/7	45/7	54/7	7w	19w	37w	61w	7w	19w
Line Guards	1	4	3	4	5	5	6	1	3	4	6	1	2
Armor Rods	3	6	7	8	9	10	12	2	5	9	12	2	6

Conductor Splice

A Conductor Splice will restore the mechanical and electrical integrity of all of the aluminum strands of ACSR, ACSS, AAC and AAAC conductors, when used within the span or at a support point. See Appendix A for catalog sheets for Conductor Splices.

Notes: For ACSR and ACSS conductors, the steel core must be intact.

For AAC & AAAC conductors, a Conductor Splice is a full tension splice.

ACSR Full Tension Splice

ACSR Full Tension Splices will restore 100% of the mechanical and electrical integrity of ACSR conductors (aluminum strands and steel core). These splices can be used within the span or at a support location. See Appendix A for catalog information.

THERMOLIGN® Splice

Full tension splices for ACSS and ACCR conductors not only have to hold at least 95% of the mechanical strength and provide 100% of the conductivity, but also must do so at elevated conductor temperatures (up to 250° C). The THERMOLIGN Splice is specially designed as a full tension splice for ACSS and ACCR conductors (round wire only), and has been thoroughly tested for high temperature performance. See Appendix A for catalog information on the THERMOLIGN Splice.

Note: THERMOLIGN Splices are not intended for use on conductors with trapezoidal aluminum stranding (ACSS/TW or ACCR/TW).

Preventative Measures

Once a conductor is repaired using one of the products described above, it is important to take preventative measures to eliminate the possibility of a reoccurrence of the same problem in the future.

For conductors damaged at support hardware, the best preventative measure is to install a suspension assembly that reduces bending stresses on the repaired conductor. As detailed earlier, the CUSHION-GRIP® Suspension, with elastomer inserts, reduces the bending stresses from aeolian vibration and galloping by 40% to 50%. Therefore, the repaired conductor will no longer be subjected to the levels of bending stress that caused the original damage.



Catalog information for the CUSHION-GRIP Suspension can be found in Appendix A.

To determine the proper size CUSHION-GRIP Suspension, the final diameter of the repaired conductor must be determined using information contained in Appendix A.

For example, the Line Guards (MG-0153) used to repair a partially damaged 636 kcmil 26/7 ACSR (“Grosbeak”) conductor have rods with a diameter of 0.182". Adding two rod diameters to the original diameter of the conductor (0.990") gives a final repaired diameter of 1.354". For this diameter, a CGS-1116 would be used.

If for the same conductor, repairs were made with Armor Rods (AR-0137) or a Conductor Splice (LS-0148), the final repaired diameter would be 1.61", which requires a CGS-1120.

Another preventative measure is the addition of vibration dampers to suppress the level of aeolian vibration after the repair is completed. The Spiral Vibration Damper (SVD) is a very effective and field proven impact-type damper for use on conductors up to 0.75" diameter. For larger conductors, the VORTX™ Damper will reduce the amplitude of vibration at the support locations to an acceptable level. Contact your PLP representative for recommendations on the use of these products.

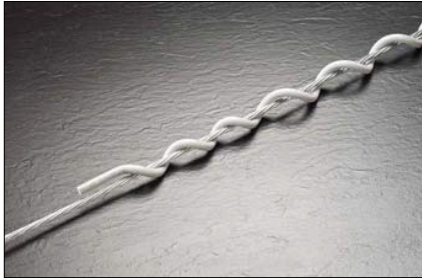

Spiral Vibration Damper



VORTX Damper

If it is suspected or known that galloping was the cause of the original damage to the conductor, Air Flow Spoilers or Detuning Pendulums can be added to the line to suppress future galloping activity. Field studies and laboratory tests have shown that Air Flow Spoilers and Detuning Pendulums are very effective in reducing the high amplitude motions associated with galloping. These products are available for both non-EHV and EHV applications. Contact your PLP representative for recommendations on the use of these products.



Air Flow Spoiler



Detuning Pendulum

OVERHEAD SHIELD WIRE (OHSW)

Repair Rods

Repair Rods for overhead shield wire are designed to restore 100% of the mechanical strength and electrical conductivity when the number of broken wires doesn't exceed 50% of the total number of wires. Repair rods can be used at support structures or within the span. See Appendix A for catalog information on Repair Rods for galvanized steel and aluminum-clad steel strands.

Note: Repair Rods are not intended to be used for full tension applications in new construction nor in repairs.

Preventative Measures

As with conductors, consideration should be given to using a CUSHION-GRIP® Support on overhead shield wire repaired at supporting structures to prevent a reoccurrence. Also, the addition of Spiral Vibration Dampers will effectively reduce any high frequency aeolian vibration to acceptable levels.

OPTICAL GROUND WIRE (OPGW)

Repair Rods

Repair Rods for optical ground wire are designed to provide up to 50% of the rated strength of typical OPGW designs utilizing aluminum-clad steel outer strands, as detailed on the relevant catalog page in Appendix A.

COMPRESSION SPLICES

Splice Shunt / Dead-end Shunt

A Splice Shunt is an effective way to restore the electrical integrity and a portion of the mechanical strength of a compression splice that has been determined from a field assessment to be suspicious or deteriorating (i.e., increased resistance ratio or high operating temperature). The Splice Shunt is designed to restore the mechanical and electrical performance of all of the aluminum strands of ACSR conductors, and 10% or more of the strength of the steel core, without having to remove the compression splice. The Dead-end Shunt restores electrical conductivity between the conductor in the span and the jumper loop.

The sets of rods that make up the Splice Shunt and Dead-end Shunt are manufactured from aluminum alloy and are coated with a conductive grit. The center section of each rod set is tightly cabled (twisted) so that it will pass over and conform to the compression splice.



Since the length and diameter of compression splices vary from different manufacturers, it is necessary to provide your PLP representative with catalog information, or dimensions of the compression splice, to assure proper fit of the Splice Shunt.

It is also possible to create a Dead-end Shunt Assembly with an additional formed-wire dead-end applied over the shunt and connected to the dead-end hardware to provide a portion of the mechanical strength of the compression dead-end (contact PLP for details).

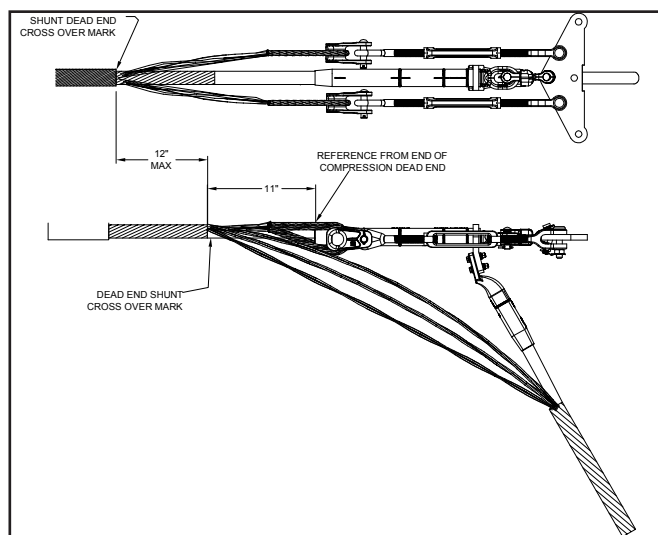

Figure 1
Dead-end Shunt with Dead-end
Single Dead-end Configuration

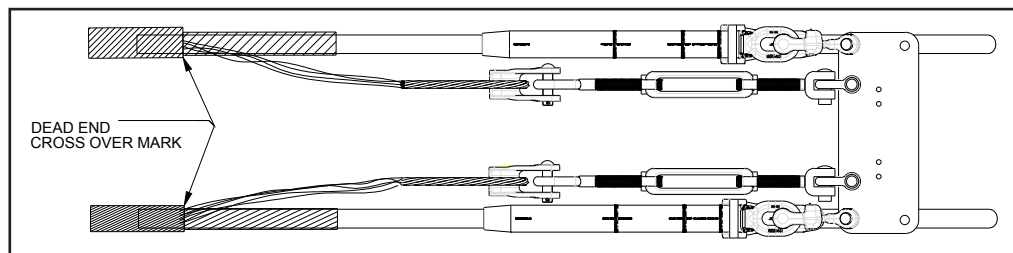

Figure 2
Dead-end Shunt with Dead-end
Double Dead-end Configuration

V. APPENDIX A - CATALOG INFORMATION

Line Guards..... 15
Armor Rods..... 19
Conductor Splices 27
ACSR Full Tension Splice 41
THERMOLIGN® Splice 44
Splice/Dead-end Shunt..... 46
CUSHION-GRIP® Suspension 48
Overhead Shield Wire Repair Rods (OHSW)..... 52
Optical Ground Wire Repair Rods (OPGW) 53



Line Guards

NOMENCLATURE

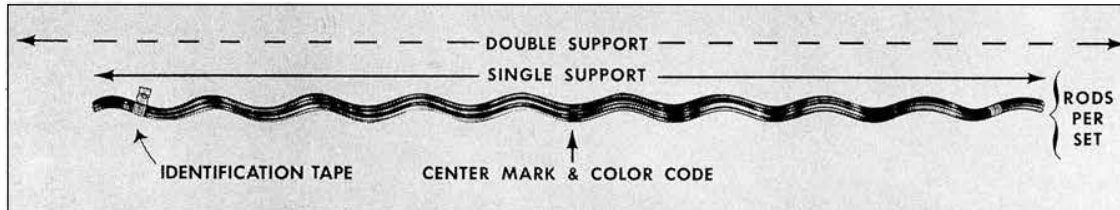

Single Support and Double Support Length: Identified by “S” and “D” appearing in the length column on the catalog page. Should the maximum distance between tied supports exceed 12 inches, consult the Factory.

Rod Diameter: Added to conductor O.D., assists in arriving at applied overall diameter.

Rods Per Set: Indicates the proper number of rods for each application.

Center Mark: Establishes recommended alignment of rods during application.

Color Code and Length:

Assists in identification of conductor size, corresponding to tabular information appearing on catalog page.

Identification Tape: Shows catalog number, nominal sizes.

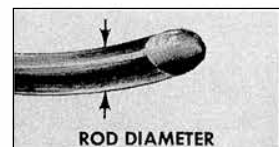
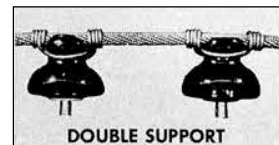

GENERAL RECOMMENDATIONS

PROTECTION. PREFORMED™ *Line Guards* are intended to protect against abrasion and arc-over, and to provide limited repair. The degree of protection needed on a specific line depends upon a number of factors such as line design, temperature, tension, exposure to wind flow, and vibration history on similar construction in the same area. As a general guide, the following recommendations may be adopted to the specific conditions.

Line Guards are recommended as minimum protection for hand-tied spans.

PLP® Factory Formed Ties are recommended as improvements over *Line Guards* secured with hand tie wire. They protect against chafing or wear caused by wind sway or unbalanced loading. **PLP Ties** also provide a stronger material and greater uniformity than hand tie wire.

Armor Rods are recommended as minimum protection for clamp-type supports or suspensions. The use of supplemental damping devices, such as Spiral Vibration Damper, should be considered when conductor vibration is present or expected.

LINE GUARDS RESTORATIVE-REPAIR. *Line Guards* may be used as patch rods designed to restore full conductance and strength to ACSR and aluminum conductors where damage is located outside the support area and does not exceed 25 percent of the outer strand layer. Consult Preformed Line Products for repair capability of specific strandings.

NOTE: When *Line Guards* are used to repair damaged aluminum-based conductors, the following application steps will produce optimum electrical repair:

Step 1: Thoroughly wire-brush damaged conductor for the full length of the *Line Guard* to be applied.

Step 2: Apply a gritted inhibitor to the full length of this area before applying the *Line Guard*.

TAPPING. *Line Guards* may be used as tap armor to protect conductors from wear and flash-over damage under hot line taps. Where it is known that tapping clamps will be installed over *Line Guards*, it is recommended that the conductor be thoroughly wire brushed clean, then an inhibitor be applied.

APPLICATION-INSPECTION. After application of the correct number of rods per set, a slight gap between rods should be present. Consult the General Information Section for detailed explanation.

Line Guards

GENERAL RECOMMENDATIONS CONTD.

Apply no more than one-half the number of rods per set at a time on smaller sizes. On conductors 4/0 and larger, do not attempt to apply more than 3 rods at a time. The alignment of the ends of the rods should be maintained within 2 inches.

Standard Line Guards are intended for non EHV applications (230kV and lower). Contact PLP for Line Guards with Parrot-Bill® rod ends for EHV applications.

O.D. CALCULATIONS

Applied overall diameter computed as follows:

The rod diameter can be obtained from the catalog page tables. Conductor/Strand O.D. can be found in the Conductor Chart, General Information Section.

Rod Diam.,	.102" x 2 = .204"
Conductor Diam.	+ .188"
Total Applied O.D.	.392"

SAFETY CONSIDERATIONS

1. This product is intended for a single (one-time) use and for the specified application. CAUTION: DO NOT REUSE OR MODIFY THIS PRODUCT UNDER ANY CIRCUMSTANCES.
2. This product is intended for use by trained craftspeople only. This product SHOULD NOT BE USED by anyone who is not familiar with and trained in the use of it.
3. When working in the area of energized lines with this product, EXTRA CARE should be taken to prevent accidental electrical contact.
4. For PROPER PERFORMANCE AND PERSONAL SAFETY be sure to select the proper size PREFORMED™ Line Guard before application.
5. PREFORMED Line Guards are precision devices. To insure proper performance, they should be stored in cartons under cover and handled carefully.



Line Guards

For use on:
ACSR, Compacted ACSR,
Aluminum Alloy
All-Aluminum, AWAC®
Compacted All-Aluminum, ACAR

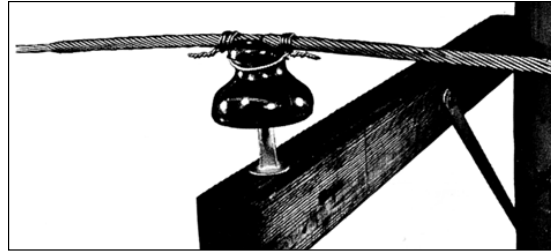

Catalog Number	Diameter Range (Inches)		Nominal Conductor Size	Units	Wt./Lbs.	Length (Inches)	Rod Diameter (Inches)	Rods Per Set	Color Code
	Min.	Max.		Per Carton					
MG-0122 MG-0305	.182	.193	#6, 7W All-Alum.	100	12 19	17(S) 29(D)	.102	7	Purple
MG-0123 MG-0306	.194	.207	#6, 6/1 #6, 7W Alum. Alloy	100	12 19	17(S) 29(D)	.102	7	Blue
MG-0125 MG-0308	.220	.228	#5, 6/1 #5, 7W Alum. Alloy	100	16 26	17(S) 29(D)	.121	7	White
MG-0126 MG-0309	.229	.243	#4, 7W All-Alum. #4, 6/1, 7/1 Comp.	100	20 32	19(S) 31(D)	.121	8	Brown
MG-0127 MG-0310	.244	.259	#4, 6/1, 7/1 #4, 7W Alum. Alloy	100	20 32	19(S) 31(D)	.121	8	Orange
MG-0128 MG-0311	.260	.273	#3, 7W All-Alum. #2, 7W Comp.	100	20 32	19(S) 31(D)	.121	8	Green
MG-0129 MG-0312	.274	.289	#3, 7W Alum. Alloy	100	25 38	21(S) 33(D)	.121	9	Yellow
MG-0130 MG-0313	.290	.308	#2, 7W All-Alum.	100	25 38	21(S) 33(D)	.121	9	Purple
MG-0131 MG-0314	.309	.326	#2, 6/1, 7/1 #2, 7W Alum. Alloy	100	25 38	21(S) 33(D)	.121	9	Red
MG-0132 MG-0315	.327	.346	#1, 7W All-Alum. 1/0, 7W-19W Comp.	100	28 42	21(S) 33(D)	.121	10	Blue
MG-0133 MG-0316	.347	.366	#1, 6/1 1/0, 6/1 Comp.	100	30 44	23(S) 35(D)	.121	10	Green
MG-0134 MG-0317	.367	.389	1/0, 7W All-Alum. 2/0, 7W-19W Comp.	100	32 46	23(S) 35(D)	.121	11	Black
MG-0135 MG-0318	.390	.413	1/0, 6/1 1/0, 7W Alum. Alloy	100	35 50	25(S) 37(D)	.121	11	Yellow
MG-0136 MG-0319	.414	.436	2/0, 7W All-Alum. 3/0, 7W-19W Comp.	50	20 29	25(S) 37(D)	.121	12	Brown
MG-0137 MG-0320	.437	.463	2/0, 6/1, 7/1 2/0, 7W Alum. Alloy	50	23 32	27(S) 39(D)	.121	13	Blue
MG-0138 MG-0321	.464	.490	3/0, 7W-19W All-Alum.	50	24 32	27(S) 39(D)	.121	13	Green
MG-0139 MG-0322	.491	.521	3/0, 6/1 3/0, 7W Alum. Alloy	50	26 36	29(S) 41(D)	.121	14	Orange
MG-0140 MG-0323	.522	.551	4/0, 7W-19W All-Alum.	50	26 36	29(S) 41(D)	.121	14	Black
MG-0141 MG-0324	.552	.585	4/0, 6/1 4/0, 7W Alum. Alloy	50	30 40	31(S) 43(D)	.121	15	Red
MG-0142 MG-0325	.586	.606	266.8, 7W-19W, 37W All-Alum.	50	40 54	31(S) 43(D)	.146	14	Black

Right-hand lay standard
 EXPLANATORY NOTES:

(Continued on next page)

- (1) Nominal Conductor size indicates one of various conductors within each range.
- (2) Single Support Length (S) and Double Support Length (D) are described on the first page of this section.
- (3) AWAC is a registered trademark of the Copperweld Co.

Line Guards

Catalog Number	Diameter Range (Inches)		Nominal Conductor Size	Units	Wt./Lbs.	Length (Inches)	Rod Diameter (Inches)	Rods Per Set	Color Code
	Min.	Max.		Per Carton					
MG-0143 MG-0326	.607	.630	266.8, 18/1 300, 19W-37 All-Alum.	50	42 57	33(S) 45(D)	.146	14	White
MG-0144 MG-0327	.631	.655	266.8, 19W Alum. Alloy (6201)	50	42 57	33(S) 45(D)	.146	14	Yellow
MG-0145 MG-0328	.656	.679	336.4, 19W-37W All-Alum.	50	48 62	35(S) 47(D)	.146	15	Brown
MG-0146 MG-0329	.680	.703	336.4, 18/1 350, 37W All-Alum.	50	48 62	35(S) 47(D)	.146	15	Blue
MG-0147 MG-0330	.704	.740	336.4, 26/7 19W Alum. Alloy (6201)	50	54 70	37(S) 49(D)	.146	16	Green
MG-0148 MG-0331	.741	.792	397.5, 18/1 26/7, 24/7	50	60 77	39(S) 51(D)	.146	17	Orange
MG-0149 MG-0332	.793	.840	477, 18/1 477, 19W-37W All-Alum.	50	64 82	39(S) 51(D)	.146	18	Purple
MG-0150 MG-0333	.841	.898	477, 24/7, 26/7 30/7	25	36 45	41(S) 53(D)	.146	19	Blue
MG-0151 MG-0334	.899	.954	556.5, 24/7, 26/7 30/7	25	46 58	43(S) 55(D)	.167	18	Green
MG-0152 MG-0335	.955	.986	605, 26/7 636, 24/7	25	54 68	45(S) 57(D)	.182	17	White
MG-0153 MG-0336	.987	1.016	636, 26/7 666.6, 24/7	25	58 72	45(S) 57(D)	.182	18	Yellow
MG-0154 MG-0337	1.017	1.064	715.5, 24/7 26/7	25	60 74	47(S) 59(D)	.182	18	Brown
MG-0155 MG-0338	1.065	1.098	874.5, 37W-61W All-Alum.	15	44 55	49(S) 61(D)	.204	17	Green
MG-0156 MG-0339	1.099	1.153	795, 26/7 30/19	15	58 72	49(S) 61(D)	.250	15	Orange
MG-0157 MG-0340	1.154	1.208	954, 45/7 54/7	15	62 75	51(S) 63(D)	.250	15	Purple
MG-0158 MG-0341	1.209	1.268	1192.5, 61W All-Alum.	15	68 82	53(S) 65(D)	.250	16	Black
MG-0159 MG-0342	1.269	1.327	1113, 54/19, 1192.5, 45/7	10	48 58	53(S) 65(D)	.250	17	White
MG-0160 MG-0343	1.328	1.390	1272, 45/7	10	50 60	55(S) 67(D)	.250	17	Yellow
MG-0161 MG-0344	1.391	1.440	1431, 45/7	5	36 44	57(S) 69(D)	.310	15	Brown
MG-0162 MG-0345	1.441	1.508	1431, 54/19	5	40 48	59(S) 71(D)	.310	16	Blue

Right-hand lay standard

EXPLANATORY NOTES:

- (1) Nominal Conductor size indicates one of various conductors within each range.
- (2) Single Support Length (S) and Double Support Length (D) are described on the first page of this section.
- (3) AWAC is a registered trademark of the Copperweld Co.



Armor Rods

NOMENCLATURE

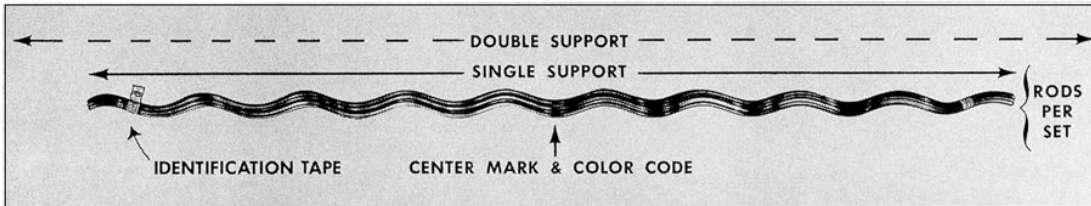

Single Support and Double Support Length: Identified by “S” and “D” appearing in the length column on the catalog page. Should the maximum distance between tied supports exceed 12 inches on double crossarm construction, consult PLP.

Rod Diameter: Added to conductor O.D., assists in arriving at applied overall diameter.

Rods Per Set: Indicate the proper number of rods for each application.

Center Mark: Establishes recommended alignment of rods during application.

Color Code and Length: Assist in identification of conductor size, corresponding to tabular information appearing on catalog page.

Identification Tape: Shows catalog number, nominal sizes.

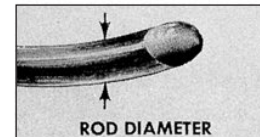
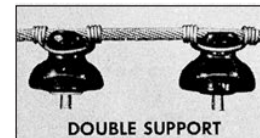

Thermal Rating (Continuous)
Within a high temperature
Suspension Clamp 250°C
ACSS Repair 250°C
ACSR Repair 125°C

GENERAL RECOMMENDATIONS

PROTECTION. PREFORMED™ Armor Rods are intended to protect against bending, compression, abrasion, arc-over, and to provide repair. The degree of protection needed on a specific line depends upon a number of factors such as line design, temperature, tension, exposure to wind flow, and vibration history on similar construction in the same area. As a general guide, the following recommendations may be adopted to the specific conditions.

Armor Rods are recommended as minimum protection for clamp-type supports or suspensions.

Line Guards are recommended as minimum protection for hand-tied spans.

The use of supplementary damping devices, such as Spiral Vibration Dampers, should be considered when conductor vibration is present or expected.

PLP® Factory Formed Ties are recommended as being superior to armor-hand tie combinations in providing protection from abrasion, and equivalent in providing protection from vibration fatigue.

ARMOR-GRIP® Suspension is recommended as being superior to armor-clamp combinations in providing protection from bending stress, compression stress and abrasion.

ARMOR RODS RESTORATIVE-REPAIR. Armor Rods may be used to restore full conductance and strength to ACSR and aluminum conductors where damage does not exceed approximately 50 percent of the outer strand layer. Consult Factory for repair capability of specific strandings.

For standard catalog numbers damage should be located at the “point of support” or within the “midspan area.” For damage 6” to 36” (152 to 914 mm) from the support point contact PLP for recommendations.

NOTE: When Armor Rods are used to repair damaged aluminum-based conductors, the following application steps are required for optimum **electrical** repair:

Step 1: Thoroughly wire-brush damaged conductor for the full length of the Armor Rods to be applied.

Step 2: Apply a gritted inhibitor to the full length of this area before applying the Armor Rods.

Armor Rods

GENERAL RECOMMENDATIONS CONTD.

TAPPING. Tapping over applied aluminum *Armor Rods* is permissible. Where it is known that tapping clamps will be installed over *Armor Rods*, it is recommended that the conductor be thoroughly wire brushed clean, then an inhibitor be applied.

APPLICATION-INSPECTION. After application of the correct number of rods per set, a slight gap between rods should be present. Consult the General Information Section for detailed explanation.

Apply no more than one-half the number of rods per set at a time on smaller sizes. On conductors 4/0 and larger, do not attempt to apply more than 4 rods at a time. The alignment of the ends of the rods should be maintained within 2 inches for voltages of 230 KV and lower.

MATERIAL SELECTION. For copper or Copperweld® conductor, Copperweld® or Phosphor Bronze, *Armor Rods* are recommended when electrical requirements such as tapping or repair are not involved.

DESIGN MODIFICATION

Armor Rods: PARROT-BILL® Ends

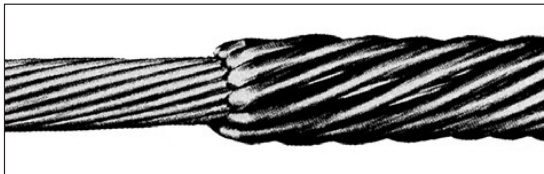

To meet the corona onset and RIV requirements for most extra-high-voltage applications, PARROT-BILL® Ends are to be used instead of the standard ball-end rods. Consult the Factory for an engineering recommendation.

O.D. CALCULATIONS

Applied overall diameter computed as follows:

The rod diameter can be obtained from the catalog page tables. Conductor/Strand O.D. can be found in the Conductor Chart, General Information Section.

Rod Diam.,	$.167" \times 2 = .334"$
Conductor Diam.	$+ .398"$
Total Applied O.D.	$.732"$

SAFETY CONSIDERATIONS

1. This product is intended for a single (one-time) use and for the specified application. CAUTION: DO NOT REUSE OR MODIFY THIS PRODUCT UNDER ANY CIRCUMSTANCES.
2. This product is intended for use by trained craftspeople only. This product SHOULD NOT BE USED by anyone who is not familiar with and trained in the use of it.
3. When working in the area of energized lines with this product, EXTRA CARE should be taken to prevent accidental electrical contact.
4. For PROPER PERFORMANCE AND PERSONAL SAFETY be sure to select the proper size PREFORMED™ *Armor Rods* before application.
5. PREFORMED *Armor Rods* are precision devices. To insure proper performance, they should be stored in cartons under cover and handled carefully.



Armor Rods: Aluminum

**For use on:
ACSR, Compacted ACSR,
Aluminum Alloy All-Aluminum,
AWAC® Compacted All-Aluminum,
ACAR, ACSS (AW & TW)**

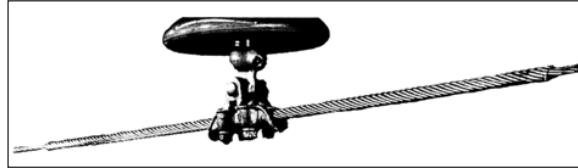

Catalog Number	Diameter Range (Inches)		Nominal Conductor Size	Units	Wt/Lbs	Length (Inches)	Rod Diameter (Inches)	Rods Per Set	Color Code
	Min.	Max.		Per Carton					
AR-0106 AR-0306	.194	.207	#6, 7W Alum. Alloy #6, 6/1	100 100	35 45	40(S) 52(D)	.121	7	Blue
AR-0107 AR-0307	.208	.219	#4, 7W, Comp.	100 100	35 45	40(S) 52(D)	.121	7	Black
AR-0108 AR-0308	.220	.228	#5, 3-7W Alum. Alloy #5, 6/1	100 100	40 51	40(S) 52(D)	.121	8	White
AR-0109 AR-0309	.229	.243	#4, 7W All-Alum. #4, 6/1-7/1 Comp.	100 100	40 51	40(S) 52(D)	.121	8	Brown
AR-0110 AR-0310	.244	.259	#4, 6/1, 7/1 #4, 7W, Alum. Alloy	50 50	25 32	40(S) 52(D)	.146	7	Orange
AR-0111 AR-0311	.260	.273	#3, 7W All-Alum. #2, 7W Comp.	50 50	26 34	42(S) 54(D)	.146	7	Green
AR-0112 AR-0312	.274	.289	#3, 7W, Alum. Alloy	50 50	30 38	42(S) 54(D)	.146	8	Yellow
AR-0113 AR-0313	.290	.308	#2, 7W All-Alum. #2, 6/1 Comp.	50 50	30 38	42(S) 54(D)	.146	8	Purple
AR-0114 AR-0314	.309	.326	#2, 6/1, 7/1 #2, 7W Alum. Alloy	50 50	32 40	44(S) 56(D)	.136	9	Red
AR-0115 AR-0315	.327	.346	#1, 7W All-Alum. #1/0, 7W-19W Comp.	50 50	38 46	46(S) 58(D)	.146	9	Blue
AR-0116 AR-0316	.347	.366	#1, 6/1 #1, 7W Alum. Alloy	50 50	40 49	48(S) 60(D)	.146	9	Green
AR-0117 AR-0317	.367	.389	1/0, 7W All-Alum. 2/0, 7W Comp.	50 50	45 55	50(S) 62(D)	.146	10	Black
AR-0118 AR-0318	.390	.413	1/0, 6/1 1/0, 7W Alum. Alloy	50 50	55 67	52(S) 64(D)	.167	9	Yellow
AR-0119 AR-0319	.414	.436	2/0, 7W-19W All-Alum. 3/0, 7W Comp.	50 50	48 58	52(S) 64(D)	.146	10	Brown
AR-0120 AR-0320	.437	.463	2/0, 6/1 3/0, 6/1 Comp.	50 50	64 76	54(S) 66(D)	.167	10	Blue
AR-0121 AR-0321	.464	.490	3/0, 7W-19W All Alum.	50 50	64 76	54(S) 66(D)	.167	10	Green
AR-0122 AR-0322	.491	.521	3/0, 6/1 3/0, 7W Alum. Alloy 4/0, 6/1 Comp.	25 25	37 46	56(S) 68(D)	.167	11	Orange
AR-0123 AR-0323	.522	.551	4/0, 7W-19W All-Alum.	25 25	38 46	58(S) 70(D)	.167	11	Black

Right-hand lay standard

(Continued on next page)

EXPLANATORY NOTES:

- (1) Nominal Conductor size indicates one of various conductors within each range.
- (2) Single Support Length (S) and Double Support Length (D) are described on the first page of the Armor Rod section.
- (3) Reference O.D. Calculations for: APPLIED O.D. Calculations.
- (4) AWAC is a registered trademark of the Copperweld Co.

Armor Rods: Aluminum

Catalog Number	EHV Armor Rod Catalog Number	Diameter Range (Inches)		Nominal Conductor Size	Units	Wt/Lbs	Length (Inches)	Rod Diameter Inches	Rods Per Set	Color Code
		Min	Max		Per Carton					
AR-0124		.552	.585	4/0, 6/1	25	46	60(S)	.182	11	Red
AR-0324					25	55	72(D)			
AR-0125		.586	.606	266.8 kcmil, 19W	25	52	62(S)	.182	12	Black
AR-0325					25	61	74(D)			
AR-0126		.607	.630	266.8 kcmil, 18/1	25	54	64(S)	.182	12	Purple
AR-0326					25	63	76(D)			
AR-0127		.631	.655	266.8 kcmil, 26/7	25	54	64(S)	.182	12	Yellow
AR-0327					25	63	76(D)			
AR-0128		.656	.679	336.4 kcmil, 19W	18	43	66(S)	.182	13	Brown
AR-0328					18	51	78(D)			
AR-0129		.680	.703	300 kcmil, 26/7	18	52	68(S)	.204	12	Blue
AR-0329					18	60	80(D)			
AR-0130		.704	.740	336.4 kcmil, 26/7	18	54	72(S)	.204	12	Green
AR-0342					18	64	84(D)			
AR-0131		.741	.782	397.5 kcmil, 18/1	18	59	72	.204	13	Orange
AR-0132		.783	.814	397.5 kcmil, 26/7	15	66	76	.250	11	Purple
AR-0133		.815	.845	636 kcmil, 19W Comp.	15	66	76	.250	11	Red
AR-0134		.846	.907	477 kcmil, 26/7	15	74	78	.250	12	Blue
AR-0135		.908	.929	636 kcmil, 37W	12	66	80	.250	13	Green
AR-0136		.930	.976	605 kcmil, 26/7	12	72	88	.250	13	White
AR-0137	AR-0500	.977	1.016	636 kcmil, 26/7	9	50	92	.310	11	Yellow
AR-0138	AR-0501	1.017	1.035	795 kcmil, 37-61W	6	55	94	.310	12	Brown
AR-0139	AR-0502	1.036	1.064	715.5 kcmil, 26/7	6	56	96	.310	12	Blue
AR-0140	AR-0503	1.065	1.098	795 kcmil, 24/7	6	56	96	.310	12	Green
AR-0141	AR-0504	1.099	1.139	795 kcmil, 26/7	6	62	100	.310	12	Orange
AR-0142	AR-0505	1.140	1.161	954 kcmil, 36/1	6	63	100	.310	13	Purple
AR-0143	AR-0506	1.162	1.208	954 kcmil, 45/7 954 kcmil, 54/7 1033.5 kcmil, 37-61W	6	69	100	.310	13	Red
AR-0144	AR-0507	1.209	1.269	1113 kcmil, 45/7	6	81	100	.365	12	Black
AR-0145	AR-0508	1.270	1.327	1192.5 kcmil, 45/7	6	81	100	.365	12	White
AR-0146	AR-0509	1.328	1.390	1272 kcmil, 45/7	3	45	100	.365	13	Yellow
AR-0147	AR-0510	1.391	1.440	1431 kcmil, 45/7	3	54	100	.436	11	Brown
AR-0163	AR-0511	1.441	1.508	1590 kcmil, 45/7	3	58	100	.436	12	Blue
AR-0164	AR-0512	1.509	1.578	1590 kcmil, 54/19	3	58	100	.436	12	Green
AR-0165	AR-0513	1.579	1.651	1780 kcmil, 84/19	3	60	100	.436	13	Orange
AR-0166	AR-0514	1.652	1.728	2000 kcmil, 9/W	3	60	100	.436	13	Purple
AR-0167	AR-0516	1.729	1.809	2156 kcmil, 84/19	3	64	100	.436	14	Red
AR-0168	AR-0517	1.810	1.898	2500 kcmil, 91W	3	64	100	.436	14	Black
AR-0169	AR-0518	1.899	1.991		3	68	100	.436	15	White
AR-0170	AR-0519	1.992	2.090	3500 kcmil, 127W	3	68	100	.436	15	Yellow
AR-0171	AR-0520	2.091	2.193	3500 kcmil, 127W	3	80	100	.468	15	Brown

Right-hand lay standard

EXPLANATORY NOTES:

- (1) Nominal Conductor size indicates one of various conductors within each range.
- (2) Single Support Length (S) and Double Support Length (D) are described on the first page of the Armor Rod section.
- (3) Reference O.D. Calculations for: APPLIED O.D. Calculations.
- (4) AWAC is a registered trademark of the Copperweld Co.



Armor Rods: ALUMINUM-CLAD STEEL

**For use on:
Aluminum-Clad Steel Strands**

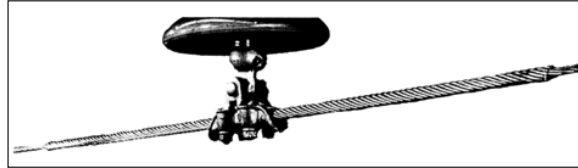

Catalog Number	Diameter Range (Inches)		Nominal Conductor Size	Units	Wt/Lbs	Length (Inches)	Rod Diameter (Inches)	Rods Per Set	Color Code
	Min.	Max.		Per Carton					
AR-2113 AR-2313	.169"	.178"	3#12 AW	50 50	32 40	40(S) 52(D)	.102	7	Orange
AR-2116 AR-2316	.196"	.207"	3#11 AW	50 50	32 40	40(S) 52(D)	.102	7	Black
AR-2118 AR-2318	.218"	.225"	3#10 AW 4-M AW	50 50	36 46	40(S) 52(D)	.102	8	Green
AR-2120 AR-2320	.237"	.249"	1/4", 7#12AW 6-M, AW, 3#9 AW	50 50	40 51	40(S) 52(D)	.102	9	Yellow
AR-2122 AR-2322	.264"	.277"	9/32", 7#11 AW 8-M, AW, 3#8 AW	25 25	28 35	42(S) 54(D)	.114	9	Blue
AR-2124 AR-2324	.296"	.314"	5/16", 7#10 AW 10-M, AW, 3#7 AW	25 25	30 37	46(S) 58(D)	.114	9	Black
AR-2126 AR-2326	.334"	.352"	11/32", 7#9 AW 12.5-M, AW, 3#6 AW	25 25	35 44	50(S) 62(D)	.114	10	Yellow
AR-2128 AR-2328	.373"	.392"	3/8", 7#8 AW 16-M, AW, 3#5 AW	25 25	44 54	50(S) 62(D)	.128	10	Orange
AR-2130 AR-2330	.409"	.425"	18-M AW	25 25	51 62	54(S) 66(D)	.128	11	Black
AR-2131 AR-2331	.426"	.450"	7/16" AW 7#7 AW 20M, AW	25 25	58 70	56(S) 68(D)	.128	12	Green
AR-2133 AR-2333	.477"	.504"	1/2" AW 7#6 AW	20 20	54 65	56(S) 68(D)	.144	11	Blue
AR-2135 AR-2335	.535"	.565"	9/16" AW 7#5 AW	10 10	40 48	60(S) 72(D)	.162	12	Yellow
AR-2137 AR-2337	.593"	.625"	5/8" AW 7#4 AW	10 10	46 56	60(S) 72(D)	.183	11	Black

Left-hand lay standard

EXPLANATORY NOTES:

- (1) Nominal Conductor size indicates one of various conductors within each range.
- (2) Single Support Length (S) and Double Support Length (D) are described on the first page of the Armor Rod section.
- (3) Reference O.D. Calculations for: APPLIED O.D. Calculations.

Armor Rods: Copperweld®

For use on:
Copperweld Strand, Copper
Copperweld®/Copper Composite

Catalog Number	Diameter Range (Inches)		Nominal Conductor Size	Units	Wt/Lbs	Length (Inches)	Rod Diameter (Inches)	Rods Per Set	Color Code
	Min.	Max.		Per Carton					
AR-5100 AR-5300	.160	.168	#6 Solid Cu	50 50	35 46	38(S) 50(D)	.102	7	Green
AR-5101 AR-5301	.169	.178	3 #12 Cu	50 50	37 48	40(S) 52(D)	.102	7	Red
AR-5102 AR-5302	.179	.188	#5 Solid Cu	50 50	37 48	40(S) 52(D)	.102	7	Black
AR-5104 AR-5304	.196	.207	3 #11 Cw 8A Cw/Cu	50 50	56 72	40(S) 52(D)	.102	7	Gray
AR-5106 AR-5306	.218	.225	3 #10 Cw	50 50	44 56	40(S) 52(D)	.102	8	Red
AR-5107 AR-5307	.226	.236	6A Cw/Cu #4, 7W Cu	50 50	44 56	40(S) 52(D)	.102	8	Black
AR-5108 AR-5308	.237	.249	6M Cu 7 #12 Cw	50 50	49 64	42(S) 54(D)	.102	9	Blue
AR-5109 AR-5309	.250	.263	#3, 7W Cu 6M Cw 3W	50 50	50 64	42(S) 54(D)	.102	9	Gray
AR-5110 AR-5310	.264	.277	8M, Cw 7 #11 Cw	50 50	57 65	42(S) 54(D)	.102	9	Green
AR-5111 AR-5311	.278	.295	#2, 7W Cu 4A Cw/Cu	50 50	56 72	42(S) 54(D)	.102	10	Red
AR-5112 AR-5312	.296	.314	10M Cw 7 #10 Cw	25 25	35 44	44(S) 56(D)	.114	9	Black
AR-5113 AR-5313	.315	.333	#1, 7W-19W Cu	25 25	44 55	46(S) 58(D)	.128	9	Blue
AR-5114 AR-5314	.334	.352	12.5M Cw 7 #9 Cw	25 25	46 58	48(S) 60(D)	.128	9	Gray
AR-5115 AR-5315	.353	.372	14M Cw 2A Cw/Cu	25 25	54 66	50(S) 62(D)	.128	10	Green
AR-5116 AR-5316	.373	.392	7#8 Cw 16M Cw, 3 #5 Cw	25 25	62 76	52(S) 64(D)	.144	9	Red
AR-5118 AR-5318	.409	.425	18M Cw 2/0, 7W-19W Cu	15 15	44 54	54(S) 66(D)	.144	10	Blue
AR-5119 AR-5319	.426	.450	7 #7 Cw 20M Cw	15 15	55 66	54(S) 66(D)	.162	10	Gray
AR-5120 AR-5320	.451	.476	1/0 K, Cw/Cu 3/0, 7W-19W Cu	15 15	57 69	56(S) 68(D)	.162	10	Green
AR-5121 AR-5321	.477	.504	7 #6Cw 3/0, 12W Cu	15 15	62 75	56(S) 68(D)	.162	11	Red
AR-5122 AR-5322	.505	.534	19 #10 Cw 25M Cw	15 15	64 78	58(S) 70(D)	.162	11	Black
AR-5123 AR-5323	.535	.565	7 #5 Cw 4/0, 12W Cu	10 10	48 58	58(S) 70(D)	.162	12	Blue
AR-5124 AR-5324	.566	.592	19 #9 Cw 250M, 19-37W	10 10	49 59	60(S) 72(D)	.162	12	Gray
AR-5125 AR-5325	.593	.625	7 #4 Cw 250M, 12W Cu	10 10	53 63	60(S) 72(D)	.162	13	Green

Left-hand lay standard

EXPLANATORY NOTES:

- (1) Nominal Conductor size indicates one of various conductors within each range.
- (2) Single Support Length (S) and Double Support Length (D) are described on the first page of the Armor Rod section.
- (3) Reference O.D. Calculations for: APPLIED O.D. Calculations.
- (4) Copperweld is a registered trademark of the Copperweld Co.



Armor Rods: Phosphor Bronze

For use on:
Copper
Copperweld®/Copper Composite

Catalog Number	Diameter Range (Inches)		Nominal Conductor Size	Units	Wt/lbs	Length (Inches)	Rod Diameter (Inches)	Rods Per Set	Color Code
	Min.	Max.		Per Carton					
ARB-1103 ARB-1303	.160	.168	#6, Solid Cu	75 75	54 70	38(S) 50(D)	.099	7	Green
ARB-1104 ARB-1304	.169	.178	9 1/2 D Cw/Cu	75 75	56 72	40(S) 52(D)	.099	7	Red
ARB-1105 ARB-1305	.179	.188	#6, 7W Cu 8C, Cw/Cu	75 75	56 72	40(S) 52(D)	.099	7	Black
ARB-1107 ARB-1307	.196	.207	#8A Cw/Cu #4, Solid Cu	50 50	44 56	40(S) 52(D)	.099	8	Gray
ARB-1109 ARB-1309	.218	.225	#8D Cw/Cu #7A Cw/Cu	50 50	44 56	40(S) 52(D)	.099	8	Red
ARB-1110 ARB-1310	.226	.236	#6A Cw/Cu #4, 7W Cu	50 50	44 56	40(S) 52(D)	.099	8	Black
ARB-1111 ARB-1311	.237	.249	#7D Cw/Cu	50 50	52 65	42(S) 54(D)	.099	9	Blue
ARB-1112 ARB-1312	.250	.263	#3, 7W Cu #2 Solid Cu	50 50	52 65	42(S) 54(D)	.099	9	Gray
ARB-1113 ARB-1313	.264	.277	#6D Cw/Cu	50 50	52 65	42(S) 54(D)	.099	9	Green
ARB-1114 ARB-1314	.278	.295	#4A Cw/Cu #2, 7W Cu	50 50	56 72	42(S) 54(D)	.099	10	Red
ARB-1115 ARB-1315	.296	.314	#2F Cw/Cu #5D, Cw/Cu	50 50	68 86	44(S) 56(D)	.111	9	Black

Left-hand lay standard

EXPLANATORY NOTES:

- (1) Nominal Conductor size indicates one of various conductors within each range.
- (2) Single Support Length (S) and Double Support Length (D) are described on the first page of the Armor Rod section.
- (3) Reference O.D. Calculations section, for: APPLIED O.D. Calculations.
- (4) Refer to General Recommendations for material selection.
- (5) Copperweld is a registered trademark of the Copperweld Co.

Armor Rods: Galvanized Steel

**For use on:
Steel Reinforced Copper Conductors with
Right-Hand Lay**

Catalog Number	Diameter Range (Inches)		Nominal Conductor Size	Units	Wt/lbs	Length (Inches)	Rod Diameter (Inches)	Rods Per Set	Color Code
	Min.	Max.		Per Carton					
AR-1154 AR-1354	.244	.259	6/1 #4-7/1	50 50	38 48	40 (S) 52 (D)	.070	12	Orange
AR-1158 AR-1358	.309	.326	6/1 #2-7/1	50 50	60 75	44 (S) 56 (D)	.086	12	Red
AR-1160 AR-1360	.347	.373	#1-6/1	50 50	70 88	48 (S) 60 (D)	.086	13	Black
AR-1162 AR-1362	.390	.413	1/0-6/1	25 25	50 62	52 (S) 64 (D)	.100	13	Yellow
AR-1164 AR-1364	.437	.463	2/0-6/1	25 25	70 84	54 (S) 66 (D)	.119	12	Blue
AR-1166 AR-1366	.491	.521	3/0-6/1	20 20	62 75	56 (S) 68 (D)	.119	13	Orange
AR-1168 AR-1368	.552	.585	4/0-6/1	15 15	66 80	60 (S) 72 (D)	.138	13	Red

Right-hand lay standard

**For use on:
Galvanized Steel Strand
with Left-Hand Lay**

Catalog Number	Diameter Range (Inches)		Nominal Conductor Size	Units	Wt/lbs	Length (Inches)	Rod Diameter (Inches)	Rods Per Set	Color Code
	Min.	Max.		Per Carton					
AR-1123	.229	.243	1/4-7W	50	37	40	.086	10	Black
AR-1124	.244	.259	1/4-3W	50	37	40	.086	10	Yellow
AR-1128	.309	.326	5/16-3W 5/16-7W HS, & EHS	50	60	44	.100	11	Black
AR-1130	.347	.373	3W 3/8-7W	50	70	48	.100	12	Orange
AR-1133	.414	.436	7/16-7W	20	52	52	.119	12	Green
AR-3139	.491	.521	1/2-7W 19W	20	62	56	.138	12	Blue

Left-hand lay standard

EXPLANATORY NOTES:

- (1) Nominal Conductor size indicates one of various conductors within each range.
- (2) Single Support Length (S) and Double Support Length (D) are described on the first page of the Armor Rod section.
- (3) Galvanized Steel Armor Rods may be suitable for application on materials other than Galvanized Steel. Consult the Factory for specific information.



Conductor Splice

NOMENCLATURE

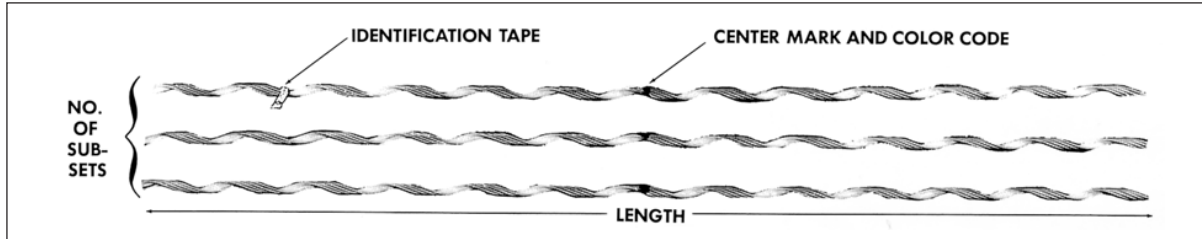

Sub-Sets: Individual rods assembled and gritted into groups (subsets), corresponding to tabular information appearing on catalog page.

Center Mark: Establishes recommended alignment of rods during application.

Color Code and Length: Assist in identification of conductor size, corresponding to tabular information appearing on catalog page.

Identification Tape: Shows catalog number, nominal sizes.

GENERAL RECOMMENDATIONS

Conductor Splices are designed as a single-component outer-layer assembly generally for Sub-EHV applications.

Conductor splices are available for EHV applications. Consult PLP for details.

JOINING: On all-aluminum, aluminum alloy, and copper conductors of homogenous stranding, the Conductor Splice will hold a minimum of 90% of the rated breaking strength of, and provide better conductance than, an equal length of unspliced conductor.

On ACSR conductor, the *Conductor Splice* will hold a minimum tension amounting to the full strength of the aluminum strands plus 10% of the steel core strength. Conductance will be better than in an equivalent length of unspliced conductor.

RESTORATIVE-REPAIR: *Conductor Splices* will restore original conductivity to all-aluminum, aluminum alloy, copper, and ACSR type conductors.

Full-rated breaking strength will be restored to homogeneous stranded conductors. On ACSR, strength will be restored to all of the aluminum strands, but not to the core. When core damage on ACSR is suspected, consult the following catalog section for *Splice: ACSR FT*.

Other PREFORMED™ products with restorative-repair capabilities are *Armor Rods*, *Line Guards*, *Splice Shunt*, and *ARMOR-GRIP® Suspension: for Line Repair*.

RATED HOLDING STRENGTH: Published for individual sizes on the page following the specification page. In arriving at "Rated Hold Strength," actual results of tests on unweathered conductor are studied, and consideration is given to dimensional tolerances for the sizes encompassed.

APPLICATION-INSPECTION: All conductors, new or weathered, must be thoroughly scratch brushed until bright and clean. Immediately thereafter, an industry accepted inhibitor (compatible with the conductor) should be applied before installing the product.

TAPPING: Tapping over a conductor splice is permissible. Whenever a tapping clamp is to be installed over a splice, it is imperative that the conductor be scratch brushed and an inhibitor be used. The outer surface of the splice should be thoroughly scratch brushed to remove any oxides and glue which may be present. Inhibitor should then be applied to the area beneath the tap itself.

Thermal Rating (Continuous)
125°C

Conductor Splice

GENERAL RECOMMENDATIONS CONTD.

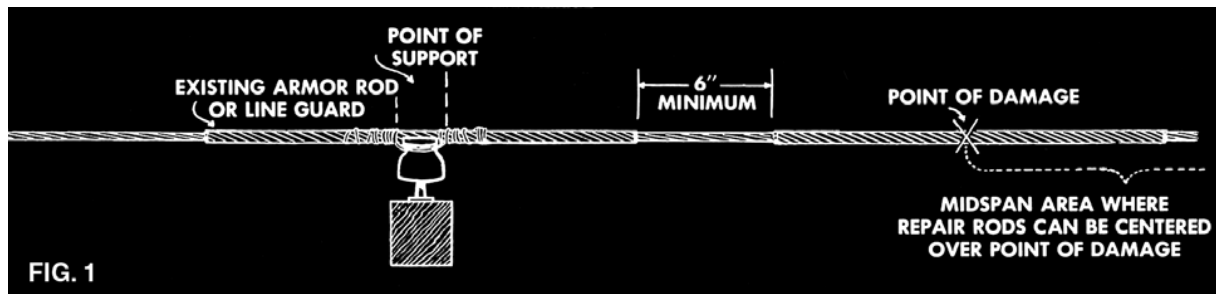

When centered over the point of damage, the ends of the *Conductor Splice* should not be positioned closer than 6 inches to existing *Armor Rods* or *Line Guards*. The Restorative-Repair function of this splice should be limited to damage located within the "Midspan Area" or the "Point of Support" (See Figure 1)

DESIGN MODIFICATIONS

Armor Splice

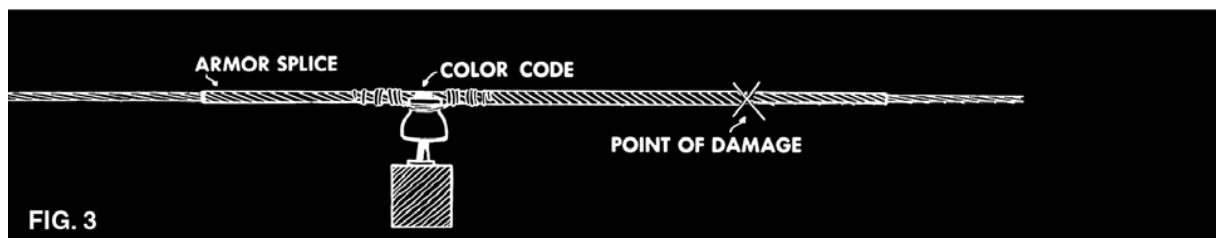
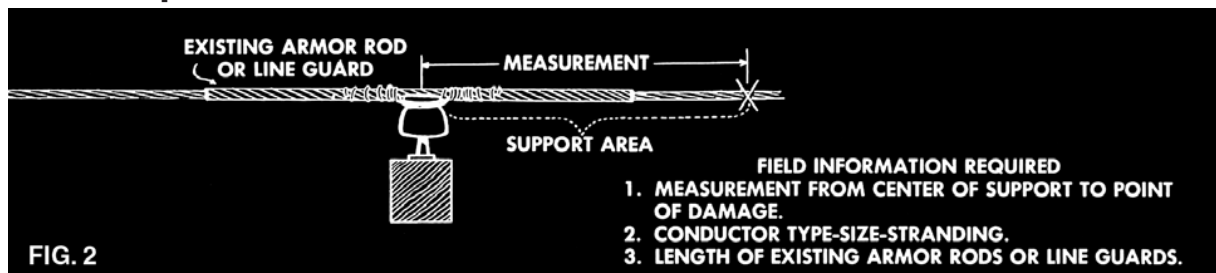

The *Armor Splice* combines the features of both *Armor Rods* and *Conductor Splices*, which are described in their respective catalog sections. The *Armor Splice* should be considered when damage occurs in the "support area," or where installation would locate the ends of repair rods within 6 inches of existing rods.

Upon receipt of the field information specified in Figure 2, PLP will furnish the correct Catalog Number. The *Armor Splice* is custom designed to assure that when the color code mark is centered at the support point, a continuous length will extend beyond the area of damage. (See Figure 3)

O.D. CALCULATIONS

Applied overall diameter computed as follows:
The rod diameter can be obtained from the price page tables. Conductor O.D. can be found in the Conductor Chart, General Information Section.

Rod Diam.	.121" x 2 = .242"
Conductor Diam.	+ .398"
Total Applied O.D.	.640"



Conductor Splice – Aluminum

For use on:
ACSR, All-Aluminum
Aluminum Alloy
AWAC® Conductor

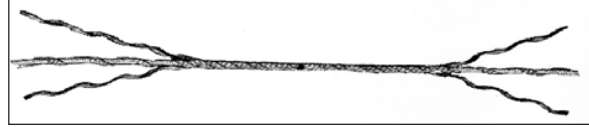

Catalog Number	Diameter Range (Inches)		Nominal Conductor Size	Units Per Carton	Wt./Lbs.	Length (Inches)	Rod Diameter (Inches)	No. of Subsets	Color Code
	Min..	Max.							
LS-0106	.177	.184	#6, 7W All-Alum.	50	6	21	.086	2	Purple
LS-0108	.194	.202	#6, 6/1 #6, 7W Alum. Alloy	50	6	22	.086	2	Blue
LS-0112	.229	.239	#4, 7W All-Alum.	50	9	24	.086	2	Brown
LS-0114	.247	.257	#4, 6/1 - 7/1 #4, 7W Alum. Alloy	50	10	26	.094	3	Orange
LS-0115	.258	.270	#3, 7W All-Alum.	50	11	26	.094	3	Green
LS-0116	.271	.280	#3, 7W Alum. Alloy	50	12	27	.094	3	Yellow
LS-0118	.290	.298	#2, 7W All-Alum.	50	13	28	.094	3	Purple
LS-0119	.299	.310	#2, AWAC 6/1 #3, AWAC 5/2	50	15	30	.102	3	Brown
LS-0120	.311	.325	#2, 6/1 - 7/1 #2, 7W Alum. Alloy	50	16	31	.102	3	Red
LS-0121	.326	.340	#1, 7W All-Alum.	50	16	31	.102	3	Blue
LS-0122	.341	.351	#1, AWAC 6/1	50	17	33	.102	3	Orange
LS-0123	.352	.367	#1, 6/1 #1, 7W Alum. Alloy	50	19	34	.102	3	Green
LS-0124	.368	.380	#1, AWAC 5/2 1/0, 7W All-Alum.	50	27	38	.121	3	Black
LS-0125	.381	.398	1/0, AWAC 6/1 1/0, 6/1 1/0, 7W Alum. Alloy	50	27	38	.121	3	Yellow
LS-0127	.414	.425	2/0, 7W All-Alum.	50	27	40	.121	3	Brown
LS-0129	.444	.462	2/0, 6/1 2/0, 7W Alum. Alloy	50	37	42	.136	3	Blue
LS-0130	.463	.481	3/0, 7W All-Alum.	50	43	46	.136	3	Green
LS-0131	.482	.503	3/0, 7W, Alum. Alloy 3/0, AWAC 6/1 3/0, 6/1	50	46	46	.146	3	Orange

Right-hand lay standard

EXPLANATORY NOTES:

- (1) Rated Holding Strengths are listed on the next page.
- (2) Nominal Conductor size indicates one of various conductors within each range. Refer to the next page for additional conductor sizes interchangeable with the same conductor splice. Consult PLP for sizes not shown.
- (3) AWAC and Copperweld are registered trademarks of the Copperweld Co.

Conductor Splice – Aluminum

RATED HOLDING STRENGTHS					
Holding strengths of the applied splices are shown in pounds. Percentage of conductor RBS shown in parentheses.					
Catalog Number	Size	ACSR	All-Aluminum	Aluminum Alloy	AWAC®
LS-0106	#6		#6, 7W 555 lbs. (100%)		
LS-0108	#6	#6, 6/1 702 lbs. (60%)		#6, 7W 1,050 lbs. (100%)	
LS-0112	#4		#4, 7W 875 lbs. (100%)		
LS-0114	#4	#4, 6/1 1,098 lbs. (60%) #4, 7/1 1,374 lbs. (60%)		#4, 7W 1,670 lbs. (100%)	
LS-0115	#3		#3, 7W 1,023 lbs. (100%)		
	#4				#4, 5/2 2,790 lbs. (100%)
LS-0116	#3			#3, 7W 2,150 lbs. (100%)	
LS-0118	#2		#2, 7W 1,335 lbs. (100%)		
LS-0119	#3				#3, 5/2 3,500 lbs. (100%)
	#2				#2, 6/1 1,590 lbs. (60%)
LS-0120	#2	#2, 6/1 1,674 lbs. (60%) #2, 7/1 2,115 lbs. (60%)		#2, 7W 2,655 lbs. (100%)	
LS-0121	#1		#1, 7W 1,625 lbs. (100%)		
LS-0122	#1				#1, 6/1 1,986 lbs. (60%)
LS-0123	#1	#1, 6/1 2,088 lbs. (60%)		#1, 7W 3,420 lbs. (100%)	
LS-0124	#1				#1, 5/2 5,450 lbs. (100%)
	1/0		1/0, 7W 1,970 lbs. (100%)		
LS-0125	1/0	1/0, 6/1 2,568 lbs. (60%)		1/0, 7W 4,230 lbs. (100%)	1/0, 6/1 2,448 lbs. (100%)
LS-0127	2/0		2/0, 7W 2,480 lbs. (100%)		
LS-0129	2/0	2/0, 6/1 2,940 lbs. (55%)		2/0, 7W 5,055 lbs. (100%)	
LS-0130	3/0		3/0, 7W 3,005 lbs. (100%)		
LS-0131	3/0	3/0, 6/1 3,671 lbs. (55%)		3/0, 7W 6,365 lbs. (100%)	3/0, 6/1 3,333 lbs. (55%)

Right-hand lay standard

EXPLANATORY NOTES:

- (1) Refer to General Recommendations at the beginning of this section for explanation of "Rated Holding Strength".
- (2) For sizes or strandings not shown, consult PLP.
- (3) Refer to the Splice: ACSR F. T. section for an alternate product with higher Rated Holding Strength on ACSR type conductors.
- (4) AWAC and Copperweld are registered trademarks of the Copperweld Co.



Conductor Splice – Aluminum

For use on:
ACSR, All-Aluminum
Aluminum Alloy
AWAC® Conductor

Catalog Number	Diameter Range (Inches)		Nominal Conductor Size	Units	Wt./ Lbs.	Length (Inches)	Rod Diameter (Inches)	No. of Subsets	Color Code
	Min.	Max.		Per Carton					
LS-0133	.522	.544	3/0, AWAC 5/2 4/0, 7W All-Alum.	50	66	51	.167	3	Black
LS-0134	.545	.567	4/0, 7W Alum. Alloy 4/0, 6/1	25	33	52	.167	3	Red
LS-0135	.568	.594	250, 19W-37W All-Alum. 4/0, AWAC 15/4 266.8, 7W-19W-37W All-Alum.	25	48	61	.182	3	Blue
LS-0136	.595	.618	266.8, 18/1	25	50	63	.182	3	Purple
LS-0137	.619	.644	266.8, 26/7 300, 19W-37W All-Alum.	25	58	67	.182	3	Yellow
LS-0138	.645	.671	300, 18/1 336.4, 19W-37W All Alum.	25	66	69	.204	3	Brown
LS-0139	.672	.700	300, 26/7 - 30/7 336.4, 18/1 - 36/1 350, 19W-37W All-Alum.	25	68	70	.204	3	Orange

Right-hand lay standard

EXPLANATORY NOTES:

- (1) Rated Holding Strengths are listed on the next page.
- (2) Nominal Conductor size indicates one of various conductors within each range. Refer to the next page for additional conductor sizes interchangeable with the same conductor splice. Consult PLP for sizes not shown.
- (3) For an example of applied overall diameter see "O.D. CALCULATIONS" at the beginning of this section.

Conductor Splice – Aluminum

RATED HOLDING STRENGTHS					
Holding strengths of the applied splices are shown in pounds. Percentage of conductor RBS shown in parentheses.					
Catalog Number	Size	ACSR	All-Aluminum	Aluminum Alloy	AWAC®
LS-0133	3/0				3/0, 5/2 9,660 lbs. (100%)
	4/0		4/0, 7W 3,790 lbs. (100%)		
LS-0134	4/0	4/0, 6/1 4,631 lbs. (55%)		4/0, 7W 8,025 lbs. (100%)	4/0, 6/1 4,059 lbs. (55%)
LS-0135	4/0				4/0, 15/4 7,560 lbs. (70%)
	250MCM		250, 19W 4,510 lbs. (100%) 250, 37W 4,860 lbs. (100%)		
	266.8MCM		266.8, 7W 4,775 lbs. (100%) 266.8, 19W 4,800 lbs. (100%) 266.8, 37W 5,185 lbs. (100%)		
LS-0136	266.8MCM	266.8, 18/1 5,130 lbs. (75%)			
LS-0137	266.8MCM	266.8, 26/7 5,625 lbs. (50%)		266.8, 19W 10,610 lbs. (100%)	
	300MCM		300, 19W 5,300 lbs. (100%) 300, 37W 5,830 lbs. (100%)		
LS-0138	300MCM	300, 18/1 5,768 lbs. (75%)			
	336.4MCM		336.4, 19W 5,940 lbs. (100%) 336.4, 37W 6,420 lbs. (100%)		
LS-0139	300MCM	300, 26/7 6,325 lbs. (50%) 300, 30/7 7,715 lbs. (50%)			
	336.4MCM	336.4, 18/1 6,469 lbs. (75%) 336.4, 36/1 5,732 lbs. (75%)			
	350MCM		350, 19W 6,180 lbs. (100%) 350, 37W 6,680 lbs. (100%)		

Right-hand lay standard

EXPLANATORY NOTES:

- (1) Refer to General Recommendations at the beginning of this section for an explanation of "Rated Holding Strength"
- (2) For sizes or strandings not shown, consult PLP.
- (3) Refer to the Splice: ACSR F. T. Section for an alternate product with higher rated holding strength on ACSR-type conductors.
- (4) AWAC and Copperweld are registered trademarks of the Copperweld Co.



Conductor Splice – Aluminum

**For use on:
ACSR, All-Aluminum
Aluminum Alloy**

Catalog Number	Diameter Range (Inches)		Nominal Conductor Size	Units	Wt./ Lbs.	Length (Inches)	Rod Diameter (Inches)	No. Of Subsets	Color Code
	Min.	Max.		Per Carton					
LS-0140	.701	.729	336.4, 26/7 336.4, 19W Alum. Alloy 397.5, 19W-37W All-Alum. 400, 19W-37W All-Alum.	15	62	77	.250	3	Green
LS-0141	.730	.760	336.4, 30/7 397.5, 18/1	15	64	79	.250	3	Black
LS-0142	.761	.792	397.5, 26/7 397.5, 19W Alum. Alloy 450, 19W-37W All-Alum.	15	74	83	.250	3	Purple
LS-0143	.793	.825	477, 18/1 - 36/1 477, 19W-37W All-Alum. 500, 19W-37W All-Alum.	3	18	84	.250	3	Red
LS-0145	.851	.886	477, 26/7 556.5, 18/1 - 36/1 556.5, 19W-37W All-Alum.	3	23	99	.250	4	Orange

Right-hand lay standard

EXPLANATORY NOTES:

- (1) Rated Holding Strengths are listed on the next page.
- (2) Nominal Conductor size indicates one of various conductors within each range. Refer to the next page for additional conductor sizes interchangeable with the same conductor splice. Consult PLP for sizes not shown.
- (3) For an example of applied overall diameter see "O.D. CALCULATIONS" at the beginning of this section.

Conductor Splice – Aluminum

RATED HOLDING STRENGTHS				
Holding strengths of the applied splices are shown in pounds. Percentage of conductor RBS shown in parentheses.				
Catalog Number	Nominal Conductor Size	ACSR	All-Aluminum	Aluminum Alloy
LS-0140	363.4	336.4, 26/7 7,025 lbs. (50%)		336.4, 19W 12,830 lbs. (100%)
	397.5		397.5, 19W 6,880 lbs. (100%) 397.5, 37W 7,305 lbs. (100%)	
	400		400, 19W 6,928 lbs. (100%) 400, 37W 7,350 lbs. (100%)	
LS-0141	336.4	336.4, 30/7 8,520 lbs. (50%)		
	397.5	397.5, 18/1 7,530 lbs. (75%) 397.5, 36/1 6,555 lbs. (75%)		
LS-0142	397.5	397.5, 26/7 8,095 lbs. (50%)		397.5, 19W 13,617 lbs. (90%)
	450		450, 19W 7,630 lbs. (100%) 450, 37W 8,110 lbs. (100%)	
LS-0143	477	477, 18/1 8,903 lbs. (75%) 477, 36/1 7,740 lbs. (75%)	477, 19W 8,090 lbs. (100%) 477, 37W 8,600 lbs. (100%)	
	500		500, 19W 8,480 lbs. (100%) 500, 37W 9,100 lbs. (100%)	
	477			477, 19W 6,371 lbs. (90%)
LS-0145	477	477, 26/7 9,715 lbs. (50%)		
	550		550, 37W 9,720 lbs. (100%) 550, 61W 9,440 lbs. (90%)	
	556.5	556.5, 18/1 10,388 lbs. (75%) 556.5, 36/1 8,850 lbs. (75%)	556.5, 19W 9,440 lbs. (100%) 556.5, 37W 9,830 lbs. (100%)	

Right-hand lay standard

EXPLANATORY NOTES:

- (1) Refer to General Recommendations at the beginning of this section for explanation of "Rated Holding Strength".
- (2) For sizes or strandings not shown, consult PLP.
- (3) Refer to the Splice: ACSR F. T. Section for an alternate product with higher rated holding strength on ACSR-type conductors.
- (4) AWAC and Copperweld are registered trademarks of the Copperweld Co.



Conductor Splice – Aluminum

**For use on:
ACSR, All-Aluminum
Aluminum Alloy**

Catalog Number	Diameter Range (Inches)		Nominal Conductor Size	Units	Wt./ Lbs.	Length (Inches)	Rod Diameter (Inches)	No. Of Subsets	Color Code
	Min.	Max.		Per Carton					
LS-0146	.887	.929	605, 36/1 636, 37W-61W All-Alum.	3	31	105	.310	3	Orange
LS-0147	.930	.968	636, 18/1 - 36/1 666.6 - 36/1	3	36	108	.310	4	Brown
LS-0148	.969	1.008	636, 54/7 - 26/7 666.6, 54/7 715.5, 36/1	3	37	111	.310	4	Yellow
LS-0149	1.009	1.050	795, 36/1 795, 37W-61W All-Alum.	3	39	121	.310	4	Green

Right-hand lay standard

EXPLANATORY NOTES:

- (1) Rated Holding Strengths are listed on the next page.
- (2) Nominal Conductor size indicates one of various conductors within each range. Refer to the next page for additional conductor sizes interchangeable with the same conductor splice. Consult PLP for sizes not shown.
- (3) For an example of applied overall diameter see "O.D. CALCULATIONS" at the beginning of this section.

Conductor Splice – Aluminum

RATED HOLDING STRENGTHS				
Holding strengths of the applied splices are shown in pounds. Percentage of conductor RBS shown in parentheses.				
Catalog Number	Nominal Conductor Size	ACSR	All-Aluminum	Aluminum Alloy
LS-0146	500	500, 30/7 12,225 lbs. (50%)		
	556.5	556.5, 26/7 11,200 lbs. (50%)		556.5, 19W 19,080 lbs. (90%)
	605	605, 36/1 9,600 lbs. (75%)		
	636		636, 37W 11,240 lbs. (100%) 636, 61W 10,520 lbs. (100%)	
LS-0147	605	605, 30/7 12,050 lbs. (50%) 605, 54/7 11,250 lbs. (50%)		
	556.5	556.5, 30/7 13,600 lbs. (50%)		
	636	636, 18/1 11,873 lbs. (75%) 636, 36/1 10,088 lbs. (75%)		
	666	666.6, 36/1 10,575 lbs. (75%)		
	700		700, 37W 12,370 lbs. (100%) 700, 61W 11,570 lbs. (100%)	
LS-0148	636	636, 26/7 12,500 lbs. (50%)		
	636	636, 54/7 11,180 lbs. (50%)		636, 37W 21,690 lbs. (90%)
	715	715.5, 36/1 11,175 lbs. (75%)	715.5, 37W 12,640 lbs. (100%) 715.5, 61W 11,835 lbs. (100%)	
	750		750, 37W 2,990 lbs. (100%) 750, 61W 12,160 lbs. (100%)	
LS-0149	795	795, 36/1 12,405 lbs. (75%)	795, 37W 13,770 lbs. (100%) 795, 61W 12,900 lbs. (100%)	
	800		800, 37W 13,850 lbs. (100%) 800, 61W 12,970 lbs. (100%)	

Right-hand lay standard

EXPLANATORY NOTES:

- (1) Refer to General Recommendations at the beginning of this section for explanation of "Rated Holding Strength".
- (2) For sizes or strandings not shown, consult PLP.



Conductor Splice – Aluminum

**For use on:
ACSR, All-Aluminum
Aluminum Alloy**

Catalog Number	Diameter Range (Inches)		Nominal Conductor Size	Units	Wt./ Lbs.	Length (Inches)	Rod Diameter (Inches)	No. of Subsets	Color Code
	Min.	Max.		Per Carton					
LS-0150	1.051	1.091	874.5, 36/1 874.5, 37W-61W All-Alum.	3	45	127	.310	4	Black
LS-0151	1.092	1.136	795, 54/7 954, 37W-61W All-Alum.	3	59	137	.365	4	Purple
LS-0152	1.137	1.183	954, 36/1-45/7 1,033.5, 37W-61W All-Alum.	3	62	141	.365	4	Red
LS-0153	1.184	1.232	1,033.5, 36/1-45/7 1,113, 61W All-Alum.	3	63	143	.365	4	Blue
LS-0155	1.300	1.353	1,272, 45/7 1,272, 61W All-Alum.	3	101	165	.436	4	Yellow

Right-hand lay standard

EXPLANATORY NOTES:

- (1) Rated Holding Strengths are listed on the next page.
- (2) Nominal Conductor size indicates one of various conductors within each range. Refer to the next page for additional conductor sizes interchangeable with the same conductor splice. Consult PLP for sizes not shown.
- (3) For an example of applied overall diameter, see "O.D. CALCULATIONS" at the beginning of this section.

Conductor Splice

RATED HOLDING STRENGTHS				
Holding strengths of the applied splices are shown in pounds. Percentage of conductor RBS shown in parentheses.				
Catalog Number	Nominal Conductor Size	ACSR	All-Aluminum	Aluminum Alloy
LS-0150	715.5	715.5, 26/7 14,050 lbs. (50%)		
	795	795, 45/7 11,450 lbs. (50%)		
	874.5	874.5, 36/1 13,425 lbs. (75%)	874.5, 37W 14,830 lbs. (100%) 874.5, 61W 14,200 lbs. (90%)	
LS-0151	795	795, 54/7 14,250 lbs. (50%) 795, 26/7 15,600 lbs. (50%)		795, 37W 27,135 lbs. (90%)
	900	900, 45/7 12,700 lbs. (50%)	900, 37W 15,270 lbs. (100%) 900, 61W 14,310 lbs. (90%)	
	954		954, 37W 16,180 lbs. (100%) 954, 61W 15,175 lbs. (90%)	
LS-0152	874.5	874.5, 54/7 15,700 lbs. (50%)		
	900	900, 54/7 16,515 lbs. (50%)		
	954	954, 36/1 14,640 lbs. (75%) 954, 45/7 13,450 lbs. (50%)		
	1,000		1,000, 37W 16,960 lbs. (100%) 1,000, 61W 15,900 lbs. (90%)	
	1,033.5		1,033.5, 37W 17,530 lbs. (100%) 1,033.5, 61W 16,430 lbs. (90%)	
LS-0153	954	954, 54/7 17,100 lbs. (50%)		954, 37W 32,780 lbs. (90%)
	1,033.5	1,033.5, 36/1 15,825 lbs. (75%) 1,033.5, 45/7 14,450 lbs. (50%)		
	1,113		1,113, 61W 17,690 lbs. (90%)	
LS-0155	1,272	1,272, 45/7 17,700 lbs. (50%)	1,272, 61W 19,800 lbs. (90%)	

Right-hand lay standard

EXPLANATORY NOTES:

- (1) Refer to General Recommendations at the beginning of this section for explanation of "Rated Holding Strength"
- (2) For sizes or strandings not shown, consult PLP.



Conductor Splice

**For use on:
AWAC® Conductor**

Aluminum								
Catalog Number	Conductor Size		Units	Wt./Lbs.	Length (Inches)	Rod Diameter (Inches)	No. of Subsets	Color Code
	AWAC	Outside Diameter (Inches)	Per Carton					
LS-0185	#4 AWAC 4/3	.281	50	21	33	.121	3	Green
LS-0186	#3 AWAC 4/3	.316	50	27	36	.136	3	Purple
LS-0187	#2 AWAC 5/2	.330	50	24	36	.121	3	Green
LS-0188	#2 AWAC 4/3	.355	50	35	40	.146	3	Purple
LS-0189	#1 AWAC 4/3	.398	50	50	45	.167	3	Red
LS-0190	1/0 AWAC 5/2	.416	50	40	44	.136	3	Orange
LS-0191	1/0 AWAC 4/3	.447	50	61	50	.167	3	Brown
LS-0192	2/0 AWAC 5/2	.467	50	49	47	.146	3	Orange
LS-0193	2/0 AWAC 4/3	.502	50	41	55	.182	3	Black
LS-0194	3/0 AWAC 4/3	.564	50	55	59	.204	3	Yellow

Aluminum-Clad Steel								
Catalog Number	Conductor Size		Units	Wt./Lbs.	Length (Inches)	Rod Diameter (Inches)	No. of Subsets	Color Code
	AWAC	Outside Diameter (Inches)	Per Carton					
LS-5112	#4 AWAC 3/4	.307	50	34	30	.102	3	Purple
LS-5113	#4 AWAC 2/5 #3 AWAC 3/4	.340 .344	50	46	33	.114	3	Blue
LS-5114	#3 AWAC 2/5 #2 AWAC 3/4	.382 .386	50	67	38	.128	3	Brown
LS-5115	#2 AWAC 2/5 #1 AWAC 3/4	.429 .434	25	55	50	.144	3	Green
LS-5116	#1 AWAC 2/5 1/0 AWAC 3/4	.482 .487	25	75	55	.162	3	Red
LS-5117	1/0 AWAC 2/5 2/0 AWAC 3/4	.541 .547	10	48	67	.183	3	Green

Right-hand lay standard

EXPLANATORY NOTES:

- (1) Conductor Splices for AWAC stranded 6/1, selected sizes stranded 5/2 and 5/4, not appearing above, can be found earlier in this section.
- (2) Rated Holding Strengths are listed on the next page.
- (3) Consult PLP for sizes, strandings, or lay direction not shown.
- (4) For an example of applied overall diameter see O.D. CALCULATIONS at the beginning of this section.
- (5) AWAC and Copperweld are registered trademarks of the Copperweld Co.

Conductor Splice

RATED HOLDING STRENGTHS								
Holding strengths of the applied splices are shown in pounds. Percentage of conductor RBS shown in parentheses.								
Catalog Number	AWAC® SIZES							
	#4	#3	#2	#1	1/0	2/0	3/0	4/0
LS-0185	#4, 4/3 4,190 lbs. (100%)							
LS-5112	#4, 3/4 6,130 lbs. (100%)							
LS-5113	#4, 2/5 8,960 lbs. (100%)							
LS-0186		#3, 4/3 5,260 lbs. (100%)						
LS-5113		#3, 3/4 7,700 lbs. (100%)						
LS-5114		#3, 2/5 11,300 lbs. (100%)						
LS-0119			#2, 6/1 1,590 lbs. (100%)					
LS-0187			#2, 5/2 4,370 lbs. (100%)					
LS-0188			#2, 4/3 6,600 lbs. (100%)					
LS-5114			#2, 3/4 9,690 lbs. (100%)					
LS-5115			#2, 2/5 13,500 lbs. (100%)					
LS-0189				#1, 4/3 8,100 lbs. (100%)				
LS-5115				#1, 3/4 11,200 lbs. (100%)				
LS-5116				#1, 2/5 16,500 lbs. (100%)				
LS-0190					1/0, 5/2 6,580 lbs. (100%)			
LS-0191					1/0, 4/3 9,680 lbs. (100%)			
LS-5116					1/0, 3/4 13,800 lbs. (100%)			
LS-5117					1/0, 2/5 19,500 lbs. (100%)			
LS-0192						2/0, 5/2 8,030 lbs. (100%)		
LS-0193						2/0, 4/3 11,900 lbs. (100%)		
LS-5117						2/0, 3/4 16,400 lbs. (100%)		
LS-0194							3/0, 4/3 14,200 lbs. (100%)	

Right-hand lay standard

EXPLANATORY NOTES:

- (1) Conductor Splices for AWAC stranded 6/1 or selected sizes stranded 5/2, not appearing above, can be found earlier in this section.
- (2) Refer to General Recommendations at the beginning of this section for explanation of "Rated Holding Strength".
- (3) Consult PLP for sizes, stranding or lay direction not shown.
- (4) AWAC is a registered trademark of the Copperweld Co.



ACSR Full Tension Splice

NOMENCLATURE

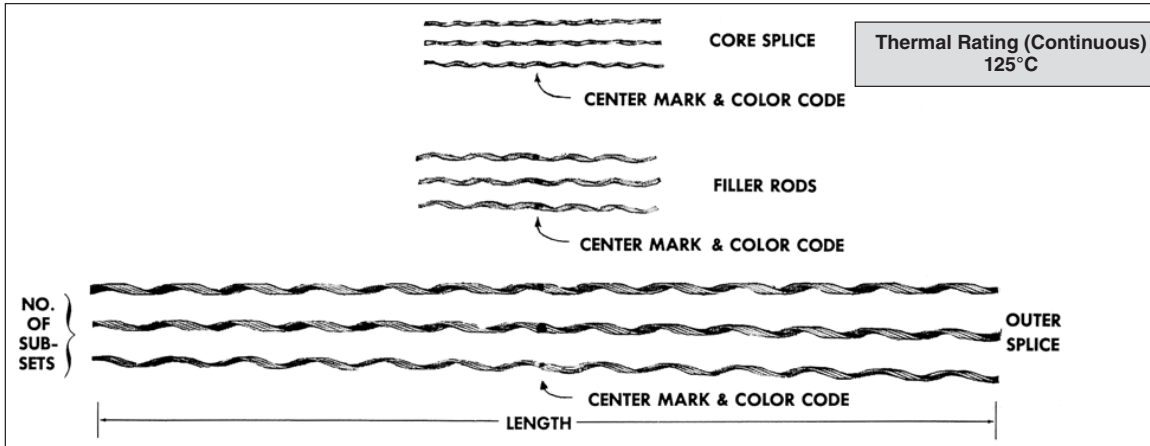

Sub-Sets: Individual rods assembled into groups of two, three, or four.

Core Splice: Galvanized steel, sub-setted and gritted.

Filler Rods: Aluminum alloy, sub-setted, or single rods, not gritted. Filler Rods are not required for selected sizes corresponding to tabular information on catalog pages.

Outer Splice: Aluminum alloy, sub-setted and gritted.

Center Mark: Establishes recommended alignment of rods during application.

Color Code and Length: Assist in identification of conductor size, corresponding to tabular information appearing on catalog pages.

Identification Tape: Shows catalog number, nominal sizes.

GENERAL RECOMMENDATIONS

SPLICE: ACSR FT. is designed as a three component assembly generally for Sub-EHV applications. Full Tension Splices are available for EHV applications. Contact PLP for details.



The Core Splice is applied after removal of the aluminum strands down to the steel core.

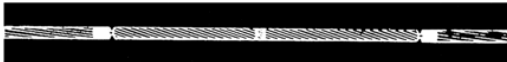

Filler rods, when required, are applied over the Core Splice to re-establish the original outside diameter of the conductor.



The Outer Splice is identical in design to the Conductor Splice (earlier in this section) except for the overall length.

JOINING: This splice will hold the full rated breaking strength of, and provide better conductivity than, an equal length of unspliced ACSR conductor.

RESTORATIVE-REPAIR: *Splice: ACSR FT.* will restore original conductivity and full rated breaking strength to ACSR conductor. This splice is recommended when damage to the core itself is suspected.

Other PREFORMED™ products with restorative-repair capabilities are *Armor Rods, Line Guards, Splice Shunt,* and *ARMOR-GRIP® Suspension: for Line Repair.*

RATED HOLDING STRENGTH: In arriving at “Rated Hold Strength,” actual results of tests on unweathered conductor are studied, and consideration is given to dimensional tolerances for the sizes encompassed.

APPLICATION-INSPECTION: All conductors, new or weathered, must be thoroughly scratch-brushed until bright and clean. Immediately thereafter, an industry accepted inhibitor (compatible with the product) should be applied before installing the product.

(Continued)

ACSR Full Tension Splice

GENERAL RECOMMENDATIONS CONTD.

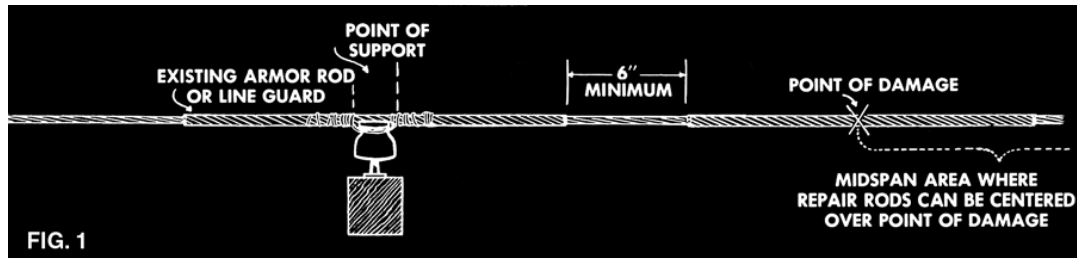

FIG. 1

When centered over the point of damage, the ends of the *Splice: ACSR FT.* should not be positioned closer than 6 inches to existing *Armor Rods* or *Line Guards*. The restorative-repair function of this splice should be limited to damage located out in the "Midspan Area" or at the "Point of Support" (see Fig. 1).

TAPPING: Tapping over a *Splice: ACSR FT.* is permissible. Whenever a tapping clamp will be installed over a splice, it is imperative that the conductor be scratch brushed and an inhibitor be used. The outer surface of the splice should be thoroughly scratch brushed to remove any oxides and glue which may be present. Inhibitor should then be applied to the area beneath the tap itself.

DESIGN MODIFICATIONS

Armor Splice

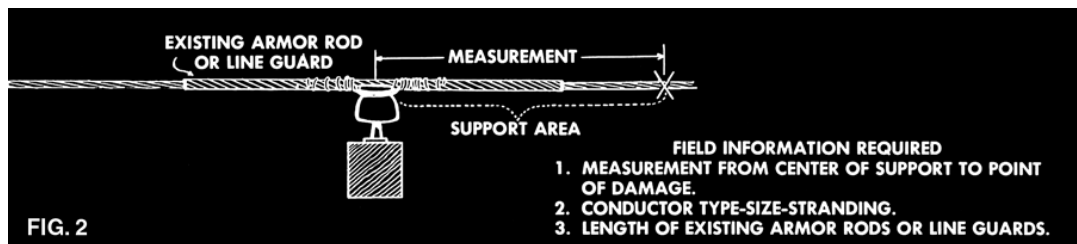

FIG. 2

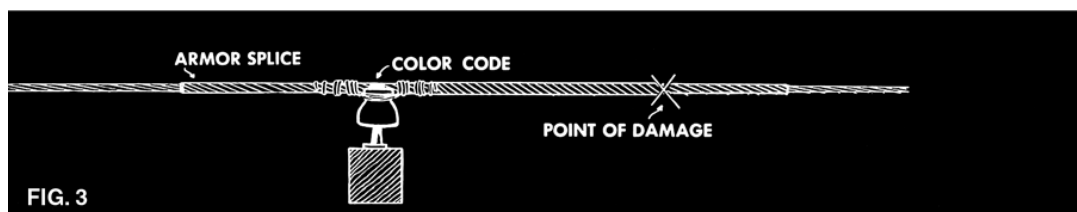

FIG. 3

The *Armor Splice* combines the features of both *Armor Rods* and *Conductor Splices*, which are described in their respective catalog sections. The *Armor Splice* should be considered when damage occurs in the "support area," or where installation would locate the ends of repair rods within 6 inches of existing rods.

Upon receipt of the field information specified in Figure 2, PLP will furnish the correct Catalog Number. The *Armor Splice* is custom designed to assure that when the color code mark is centered at the support point, a continuous length will extend beyond the area of damage. (See Figure 3)

O.D. CALCULATIONS

Applied overall diameter computed as follows:
Conductor O.D. can be found in the Conductor Chart, General Information Section.

Rod Diam.	.121" x 2 = .242"
Conductor Diam.	+ .398"
Total Applied O.D.	<u>.640"</u>



ACSR Full Tension Splice

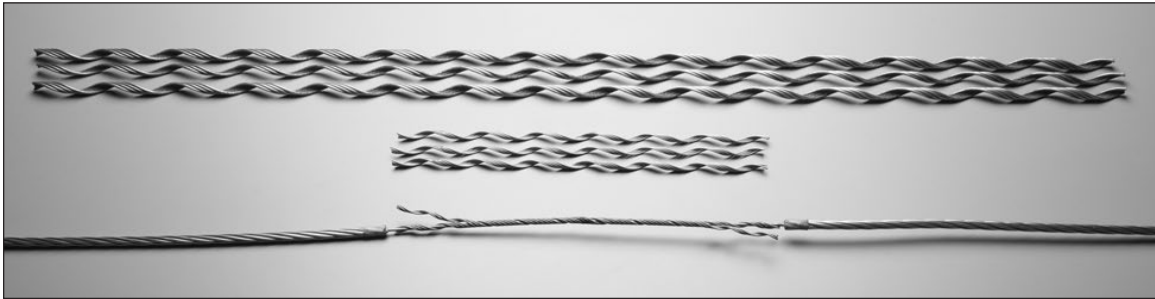

For use on: ACSR

Catalog Number	ACSR Conductor Size	Units	Wt./Lbs.	Outer Splice		Rod Diameter (Inches)	Color Codes		
		Per Carton		Length (Inches)	No. of Subsets		Core	Filler	Outer
FTS-5100	#4, 6/1	100	34	35	3	.094	Black	None	Orange
FTS-5101	#4, 7/1	100	34	35	3	.094	Black	None	Orange
FTS-5102	#2, 6/1	100	58	44	3	.102	Black	None	Red
FTS-5103	#2, 7/1	100	66	45	3	.102	Black	None	Red
FTS-5104	1/0, 6/1	50	80	52	3	.121	Black	Black	Yellow
FTS-5105	2/0, 6/1	50	65	55	3	.136	Black	Black	Blue
FTS-5108	3/0, 6/1	25	38	59	3	.146	Black	Black	Orange
FTS-5110	4/0, 6/1	25	56	67	3	.167	Black	Black	Red
FTS-5106	101.8, 12/7	25	40	65	3	.136	Black	None	Blue
FTS-5107	110.8, 12/7	25	50	69	3	.136	Black	None	Green
FTS-5109	134.6, 12/7	10	68	75	3	.167	Black	None	Purple
FTS-5111	266.8, 26/7	10	40	91	3	.182	Black	None	Yellow
FTS-5112	336.4, 18/1	10	40	87	3	.204	Black	Black	Blue
FTS-5113	336.4, 26/7	10	65	103	3	.250	Black	Black	Green
FTS-5114	336.4, 30/7	10	70	108	3	.250	Black	Black	Orange
FTS-5115	397.5, 26/7	5	40	110	3	.250	Black	Black	Purple
FTS-5116	477, 24/7	5	40	113	3	.250	Black	Black	Blue
FTS-5117	477, 26/7	5	48	120	4	.250	Black	Black	Blue
FTS-5118	556.5, 26/7	3	44	129	3	.310	Black	Black	Green
FTS-5119	636, 24/7	3	48	132	4	.310	Black	Black	Yellow
FTS-5120	636, 26/7	3	50	134	4	.310	Black	Black	Yellow
FTS-5121	795, 45/7	3	52	153	4	.310	Black	Black	Blue
FTS-5122	795, 26/7	3	78	158	4	.365	Black	Black	Orange
FTS-5123	1,272, 45/7	3	133	203	4	.463	Black	Black	Yellow

Right-hand lay standard

EXPLANATORY NOTES:

- (1) ACSR Conductor Sizes should be used only with Catalog Numbers shown.
- (2) Rated Holding Strengths are 100% of the conductor rated breaking strength (RBS).
- (3) Contact PLP for sizes or strandings not shown.

THERMOLIGN® Splice

NOMENCLATURE

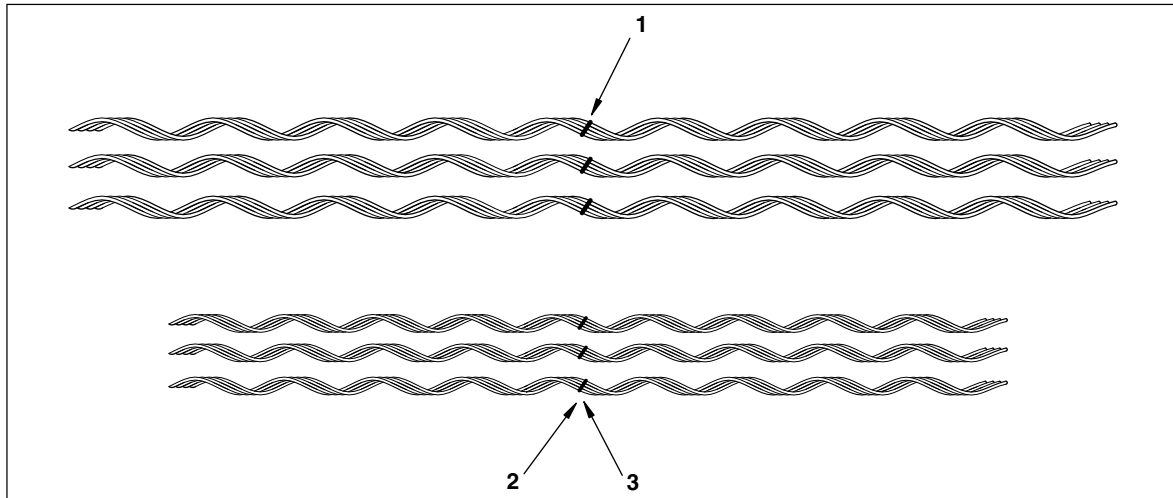

1. Inner Rods, Multiple Subsets (Aluminum Alloy)
2. Outer Rods, Multiple Subsets (Aluminum Alloy)
3. Center Mark & Color Code

GENERAL RECOMMENDATIONS

The THERMOLIGN Splice is intended for use on ACSS/AW and ACCR (not for use on conductors with trapezoidal outer strands). The design allows for continuous conductor operating temperatures up to 250°C.

THERMOLIGN Splices are intended for use on ACSS/AW and ACCR conductors only. For ACSS/TW, THERMOLIGN Splices are approved for use on General Cable and Southwire® conductors only. For 3M ACCR/TW and Southwire C7/TW conductors, please contact PLP for details.

GENERAL SPECIFICATIONS

Holding strength: 95% or more of the conductor rated breaking strength (RBS).

FEATURES AND BENEFITS

- No compression press and dies required – installation time is minimal
- Simple two layer design – no need to separately expose and splice core

Thermal Rating (Continuous)
250°C



THERMOLIGN® Splice

**For use on:
ACSS/AW, ACSS/TW* and ACCR** (Round Wire)**



Catalog Number	Diameter Range		Nominal Cond. (kcmil)	Length Inches		Color Code
	Min.	Max.		Inner Rods	Outer Rods	
TLSP-0100	0.720" (18.3mm)	0.720" (18.3mm)	336.4	118	108	Blue
TLSP-0101	0.741" (18.8mm)	0.752" (19.1mm)	336.4, 397.5	119	109	Brown
TLSP-0102	0.772" (19.6mm)	0.783" (19.3mm)	397.5	121	111	Pink
TLSP-0103	0.806" (20.5mm)	0.823" (20.9mm)	397.5, 477	124	114	Green
TLSP-0104	0.846" (21.5mm)	0.860" (21.8mm)	477	131	121	Red
TLSP-0105	0.883" (22.4mm)	0.900" (22.9mm)	477	133	123	Purple
TLSP-0106	0.901" (22.9mm)	0.914" (23.2mm)	556.5	135	125	Yellow
TLSP-0107	0.927" (23.5mm)	0.930" (23.6mm)	556.5	136	126	Orange
TLSP-0108	0.953" (24.2mm)	0.962" (24.4mm)	556.5, 605	146	136	Black
TLSP-0109	0.963" (24.5mm)	0.977" (24.8mm)	605, 636	147	137	Blue
TLSP-0110	0.990" (25.1mm)	0.994" (25.2mm)	605, 636	149	139	Brown
TLSP-0111	1.000" (25.4mm)	1.019" (25.9mm)	636, 666	151	141	Pink
TLSP-0112	1.036" (26.3mm)	1.063" (27.0mm)	715.5, 795	152	142	Green
TLSP-0113	1.081" (27.4mm)	1.092" (27.7mm)	715.5, 795	154	144	Red
TLSP-0114	1.108" (28.1mm)	1.140" (29.0mm)	795	159	149	Black
TLSP-0115	1.162" (29.5mm)	1.175" (29.8mm)	954	162	152	Purple
TLSP-0116	1.196" (30.4mm)	1.212" (30.8mm)	954, 1033.5	163	153	Yellow
TLSP-0117	1.240" (31.5mm)	1.259" (32.0mm)	1033.5, 1113	165	155	Orange
TLSP-0118	1.290" (32.8mm)	1.302" (33.1mm)	1113, 1192.5	171	161	Black
TLSP-0119	1.338" (34.0mm)	1.345" (34.2mm)	1192.5, 1272	174	164	Blue
TLSP-0120	1.380" (35.1mm)	1.386" (35.2mm)	1272, 1351.5	177	167	Red
TLSP-0121	1.420" (36.1mm)	1.427" (36.2mm)	1351.5, 1431	181	171	Purple
TLSP-0122	1.465" (37.2mm)	1.466" (37.2mm)	1431	183	173	Yellow
TLSP-0123	1.492" (37.9mm)	1.505" (38.2mm)	1510.5, 1590	185	175	Orange
TLSP-0124	1.540" (39.1mm)	1.544" (39.2mm)	1590	188	178	Green

* For ACSS/TW, THERMOLIGN Splices are approved for use on General Cable and Southwire® conductors only.

** For 3M ACCR/TW and Southwire C7/TW conductors, please contact PLP for details.

Splice/Dead-end Shunt

NOMENCLATURE

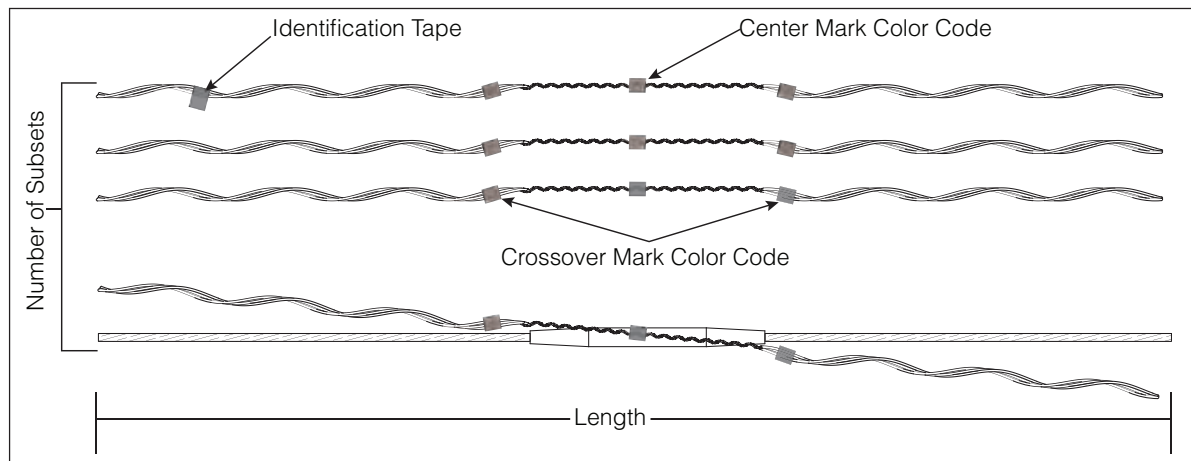

Subsets:

Individual rods assembled and gritted into groups (subsets), corresponding to tabular information appearing on catalog page.

Center Mark:

Establishes proper alignment of subsets centered on affected splice.

Color Code and Length:

Assists in identification of conductor size, corresponding to tabular information appearing on catalog page.

Identification Tape:

Shows catalog number, nominal sizes.

Application/Crossover Mark:

Indicates location where subsets wrap/apply on the conductor on either side of the splice.



GENERAL RECOMMENDATIONS

The Splice Shunt is designed to restore electrical conductivity and a portion of the mechanical strength to compression splices. The Dead-end Shunt restores electrical conductivity between the conductor in the span and the jumper loop.

In addition to using a Shunt for repair of faulty compression fittings, it can be used to reinforce and reduce the temperature of existing compression fittings for increasing the capacity (uprating) of a line.

Thermal Rating (Continuous)
125°C ACSR, AAC, AAAC
250°C ACSS, ACCR

FEATURES AND BENEFITS

- Rods are sub-setted into groups for ease of application
- Rods are made of high strength, high conductivity, aluminum alloy
- Center section is "cabled" tightly to pass over a splice or around a dead-end/terminal assembly
- Conductive grit on inner surface of rods assure electrical contact with cleaned conductor surface.

APPLICATIONS

- ACSR (50% to 100% of RBS holding strength)
- AAC & AAAC (100% of RBS holding strength)
- ACSS, ACSS/TW, ACCR (50% to 100% of RBS holding strength)



Splice/Dead-end Shunt

Catalog Number	Conductor Range (in)	Nominal Conductor Size	Wire Size	Rods per Set (subsets)	Length (in)	Splice Length (in)	Color Code	EHV
SDES-0001	0.701 - 0.729	397.5 19 str AAC	0.250	10(2-2-3-3)	108	20	Green	
SDES-0002	0.730 - 0.760	336.4 30/7 ACSR	0.250	10(2-2-2-2-2)	123	30	Black	
SDES-0003	0.761 - 0.792	397.5 kcmil 26/7 ACSR	0.250	11(3-4-4)	125	30	Purple	
SDES-0004	0.793 - 0.825	477 kcmil 18/1 ACSR	0.250	11(2-3-3-3)	122	30	Red	
SDES-0005	0.826 - 0.850	477 kcmil 24/7 ACSR	0.250	11(3-4-4)	138	30	Black	
SDES-0006	0.851 - 0.886	477 kcmil 26/7 ACSR	0.250	12(3-3-3-3)	138	32	Black	
SDES-0007	0.887 - 0.929	556.5 kcmil 26/7 ACSR	0.310	10(2-2-3-3)	145	32	Orange	
SDES-0008	0.918 - 0.968	605 kcmil 24/7 ACSR	0.310	11(2-2-2-2-3)	148	32	White	
SDES-0009	0.969 - 1.008	636 kcmil 26/7 ACSR	0.310	11(2-3-3-3)	151	34	Yellow	
SDES-0010	1.009 - 1.050	795 kcmil 36/1 ACSR	0.365	10(2-2-3-3)	168	34	Green	
SDES-0011	1.051 - 1.091	795 kcmil 45/7 ACSR	0.365	10(2-2-3-3)	187	34	Black	
SDES-0012	1.092 - 1.136	795 kcmil 26/7 ACSR	0.365	11(2-2-2-2-3)	183	40	Green	Y
SDES-0013	1.137 - 1.183	954 kcmil 45/7 ACSR	0.365	11(2-3-3-3)	187	40	Red	Y
SDES-0014	1.184 - 1.232	1033.5 kcmil 45/7 ACSR	0.436	10(2-2-3-3)	216	42	Blue	Y
SDES-0015	1.233 - 1.299	1033.5 kcmil 54/7 ACSR	0.436	10(2-2-2-2-2)	218	42	Green	Y
SDES-0016	1.300 - 1.353	1192 kcmil 45/7 ACSR	0.436	11(2-3-3-3)	220	45	Yellow	Y
SDES-0017	1.382 - 1.387	1272 kcmil 54/19 ACSR	0.436	11(2-3-3-3)	237	45	Brown	Y
SDES-0018	1.410 - 1.467	1600 AAAC	0.436	11(2-3-3-3)	219	45	Yellow	Y
SDES-0019	1.468 - 1.528		0.436	12(3-3-3-3)	228	45	White	Y
SDES-0020	1.504 - 1.545	1590 kcmil 45/7 ACSR	0.365	14(2-3-3-3-3)	226	45	White	Y
SDES-0021	1.592 - 1.657	1780 kcmil 84/19 ACSR	0.468	12(3-3-3-3)	261	45	Purple	Y
SDES-0022	1.740 - 1.810	2156 kcmil 84/19 ACSR	0.365	16(2-2-3-3-3-3)	250	45	Purple	Y
SDES-0023	1.811 - 1.870	2492 kcmil 54/37 ACAR	0.496	12(3-3-3-3)	288	45	Purple	Y

NOTES:

- Special Shunts can be designed and produced for longer splice lengths (contact PLP for details)
- For larger conductors special Dead-end Shunts can be produced with a shorter length for applications to the jumper loop (contact PLP for details)
- It is possible to create a Dead-end Shunt Assembly with an additional formed-wire dead-end applied over the shunt and connected to the dead end hardware to provide a portion of the mechanical strength, of the compression dead-end (contact PLP for details)



CUSHION-GRIP® Suspension

NOMENCLATURE

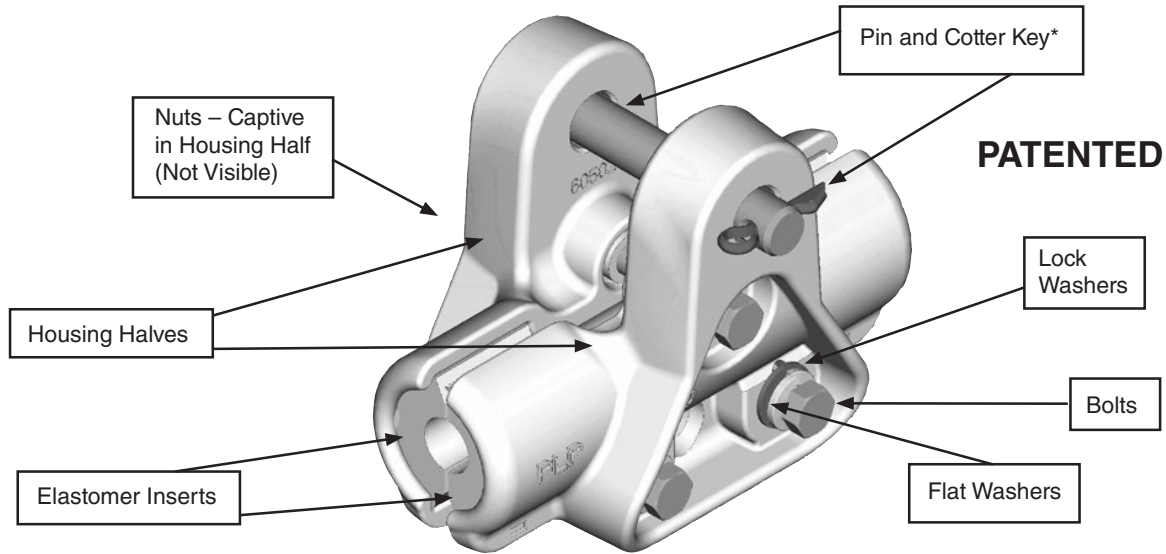

GENERAL RECOMMENDATIONS

CUSHION-GRIP Suspensions are intended for use on all aluminum based conductors, and are designed to reduce the static and dynamic stresses at the support point so that the conductor is protected against the effects of oscillations. The conductor is cushioned by field proven, integral elastomer inserts, which guard against abrasion, wear, and fatigue.

The level of protection provided by the CUSHION-GRIP Suspension is comparable to a bolted clamp over armor rods. This equates to a reduction in bending strain as high as 50% as compared to bare conductor in a bolted clamp. This reduction in bending strain can be directly related to an increase in overall conductor life. The standard CUSHION-GRIP Suspension is designed for up to 125°C continuous conductor operation (150°C two hour emergency) and the CGS-HT version can be used for applications with continuous conductor operating temperatures up to 200°C (225°C two hour emergency).

Thermal Rating (Continuous)
Standard 125°C
HT Version 200°C

Features and Benefits:

- The CUSHION-GRIP Suspension is shipped assembled with no loose parts. All fasteners are factory installed to eliminate lost hardware in the field.
- Labor Savings – To install the CUSHION-GRIP Suspension simply spread the body halves, place over the conductor, and tighten bolts.
- Integral Cushions – minimize conductor bending stresses at critical entry locations.
- Compatible with standard attachment hardware.
- Designed for EHV applications – corona free in bundled 345 kV applications.
- Easy Hot Stick application – Lower captive fasteners act as hinge to facilitate hot stick application.

VERTICAL ULTIMATE LOAD. The vertical ultimate load of the CUSHION-GRIP Suspension is listed in the table on the next page.

SLIP LOAD. When initially installed, the CGS Clamp has a slip load that ranges between 10% to 15% of the conductor's rated breaking strength (RBS).

LINE ANGLE. The maximum recommended line angle for a CUSHION-GRIP Suspension is 30° as a single suspension and 60° in a double configuration utilizing a yoke plate.

* Can be supplied with a bolt/nut/cotter in place of the suspension pin and cotter.

CUSHION-GRIP® Suspension

Catalog Number Range	Conductor Range Inches (mm)		Nominal Conductor Size	Height Inches (mm)	Width Inches (mm)		Length Inches (mm)	Weight Pounds (kg)	Standard Carton Quantity	Vertical Ultimate Load
	Min.	Max.			Min.	Max.				
CGS-1095	0.312 (7.9)	0.608 (15.4)	#2-4/0	4.85 (123 mm)	0.80 (9 mm)	1.20 (30 mm)	6.5 (165)	2.5 (1.1 kg)	10 units	15,000 lbs. (67 kN)
CGS-1096	0.609 (15.5)	0.883 (22.4)	266.8-477	5.30 (135 mm)	3.30 (84 mm)	3.85 (98 mm)	6.85 (169 mm)	4.00 (1.8 kg)	3 units	25,000 lbs. (111 kN)
CGS-1097	0.884 (22.5)	1.196 (30.4)	556.5-954	6.00 (152 mm)	3.30 (84 mm)	3.85 (98 mm)	7.55 (192 mm)	5.5 (2.5 kg)	3 units	
CGS-1098	1.197 (30.4)	1.545 (39.2)	1033.5-1590	6.25 (159 mm)	3.30 (84 mm)	3.85 (98 mm)	8.60 (218 mm)	6.7 (3.0 kg)	3 units	
CGS-1120	1.546 (39.2)	1.569 (39.8)		7.60 (183 mm)	3.90 (99.8 mm)	4.40 (111.8 mm)	9.20 (234 mm)	9.5 (4.3 kg)	3 units	30,000 lbs (136 kN)
CGS-1121	1.570 (39.8)	1.639 (41.6)	1780; 84/19							
CGS-1122	1.640 (41.7)	1.707 (43.3)								
CGS-1123	1.708 (43.4)	1.77 (45.0)	2156; 84/19 & 72/7							
CGS-1124	1.772 (45.0)	1.833 (46.5)	2312; 76/19							
CGS-1125	1.834 (46.6)	1.892 (48.0)								
CGS-1126	1.893 (48.1)	1.948 (49.5)								
CGS-1127	1.949 (49.5)	2.001 (50.8)								

NOTES: For high temperature (HT) version add HT to the catalog number (Example - CGS -1096-HT).

Add CE, YC, or SE to catalog number to include Clevis Eye, Y-Clevis Eye or Socket Eye
(Example: CGS1096SE or CGS-1096HTSE).

For bolt, nut & cotter pin in place of pin, add BNK to catalog number (Examples: CGS-1096-BNK, CGS-1096HTBNK).



CUSHION-GRIP® Suspension

DIMENSIONAL TABLES

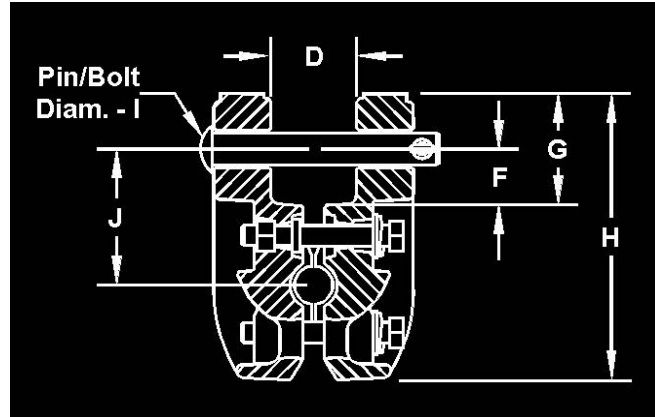
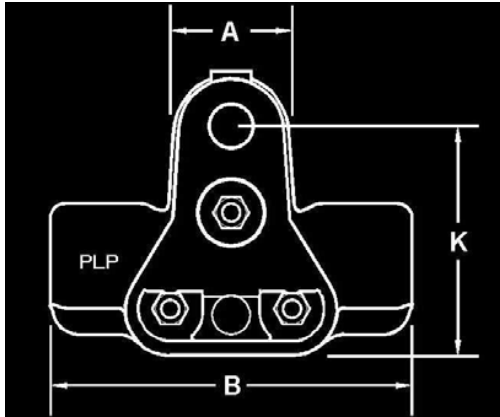

Conductor Range – Inches (mm)		Dimensions – Inches (mm)									
		A	B	D		F	G	H	I	J	K
Min.	Max.			Min.	Max.						
0.312 (7.9)	0.608 (15.4)	2.00 (51)	6.5 (165)	0.80 (20.3)	1.20 (30.5)	1.00 (25.4)	2.00 (51)	4.85 (123)	5/8 (15.9)	2.40 (61)	3.85 (98)
0.609 (15.5)	0.883 (22.4)	2.25 (57)	6.85 (174)	1.15 (29.2)	1.70 (43.2)	1.05 (26.6)	2.00 (51)	5.30 (135)	5/8 (15.9)	2.60 (66)	4.30 (109)
0.884 (22.5)	1.196 (30.4)	2.25 (57)	7.55 (192)	1.15 (29.2)	1.70 (43.2)	1.05 (26.6)	2.00 (51)	6.00 (152)	5/8 (15.9)	2.70 (69)	5.00 (127)
1.178 (29.9)	1.545 (39.2)	2.25 (57)	8.60 (218)	1.15 (29.2)	1.70 (43.2)	1.10 (27.9)	2.10 (53.5)	6.25 (159)	5/8 (15.9)	2.90 (74)	5.24 (133.4)
1.546 (39.2)	2.001 (50.8)	2.50 (63.5)	9.20 (234)	1.25 (32.8)	1.80 (45.7)	1.25 (32.8)	2.50 (63.5)	7.60 (193)	5/8 (15.9)	3.50 (89)	6.35 (161.3)

See diagram above for CGS dimensions for assistance in choosing the appropriate mating hardware part numbers.

CGS HARDWARE & FITTINGS

Shown below are the Clevis Eye (1), Y-Clevis Eye (2), Socket Eye (3), Socket Clevis (4), Yoke Plate (5), Vertical Bundle Links (6) and Hold-Down Shackles (7) that can be used in conjunction with the CUSHION-GRIP Suspension.

NOTE: See Section 8 – Transmission Line String Hardware for detailed dimensions of these components.

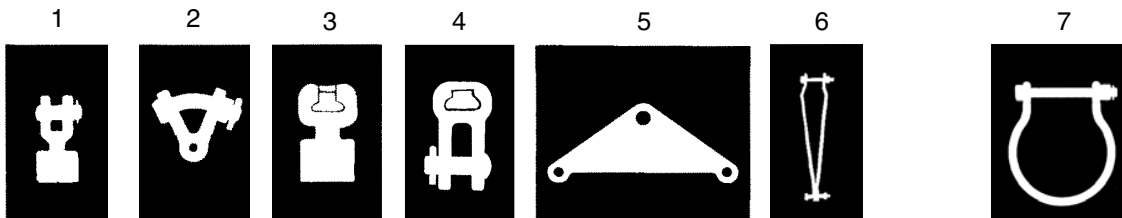

1	2	3	4	5	6	7
CE-5105 CE-5259 (for CGS-1095)	YC-5209 YC-5206 (for CGS-1095)	SE-5152 (for CGS-1095) SE-5156 (for use with CGS-1096, 1097, 1098) SE-5157 (for CGS-1120-1128)	SC-5194	YP-5907	VBL-MS-11244 (12") VBL-MS-11302 (18")	

Conductor Range	Hughes Brothers	Hubbell
0.609" – 1.196"	1888.5	88016 – 2000
1.197" – 1.545"	1888.8	88018 – 2000
1.546" – 2.052"	1888.8	N/A

CUSHION-GRIP® Suspension

For use on:
Galvanized Steel Strand



Catalog Number	Conductor Range Inches (mm)		Nominal Conductor Sizes	H	D		B		Standard Carton Quantity	Vertical Ultimate Load
	Min.	Max.		Height Inches (mm)	Width Inches (mm)		Length Inches (mm)	Weight Pounds (Kg)		
					Min.	Max.				
CGS-1095G	.312 (7.9)	.608 (15.5)	5/16"-1/2"	4.62 (117)	.80 (20.3)	1.20 (30.5)	5.5 (140)	5 (2.2)	3	20,000 lbs (84 KN)

DIMENSIONAL TABLES

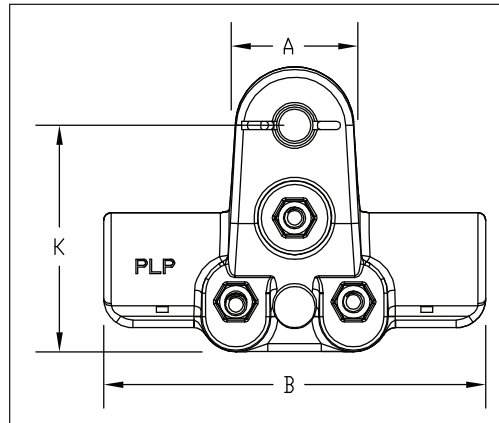
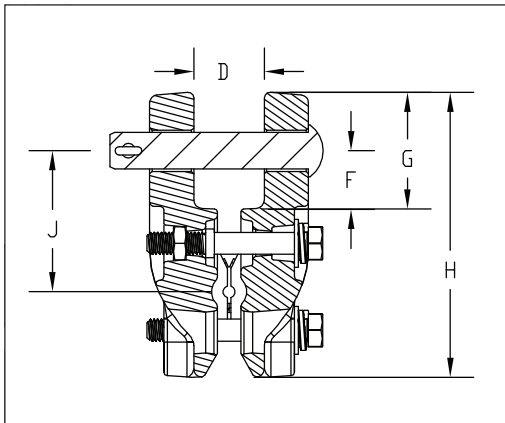

Dimensions – Inches (mm)									Material
A	B	D	F	G	H	I	J	K	
2.00 (50.8)	5.48 (139.2)	1.10 (27.94)	0.98 (24.89)	1.98 (50.30)	4.62 (117.34)	.625 (15.87)	2.40 (60.96)	3.62 (91.95)	Ductile Iron

CGS HARDWARE & FITTINGS

1



CE-5261

2



YC-5207

3



SE-5152

NOTE: See section 8 – Transmission Line String Hardware for detailed dimensions of these components.

Overhead Shield Wire Repair Rods

NOMENCLATURE

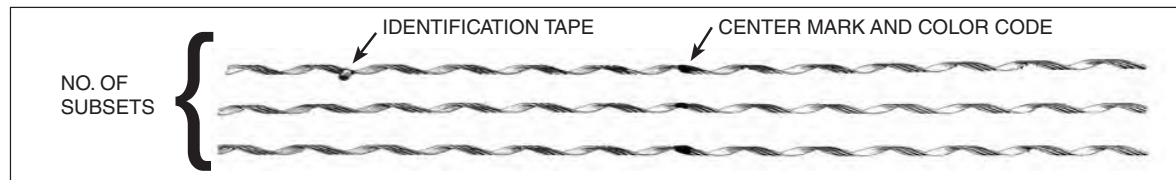

Subsets: Individual aluminum clad steel rods assembled into groups. The bore is coated with conductive grit.

Center Mark: Establishes recommended alignment of rods during application.

Color code: Provides identification for application of OHSW size that corresponds to tabular information appearing on catalog page.

Identification Tape: Shows catalog number, nominal sizes.

GENERAL INFORMATION

Repair rods for overhead shield wire are designed to restore 100% of both the mechanical strength and electrical conductivity **when the number of broken wires do not exceed 50% of the total number of wires.**

Repair rods can be used at the support structures or within the span. **Overhead shield wire repair rods can not be used as a full tension splice.**

For Galvanized Steel OHSW (left hand lay)

Catalog Number	OHSW Size inches	Length Inches	Rod Diameter inches	Number of Subsets	Color Code
OHSW-0102	3/16	35	0.086	2	Red
OHSW-0103	7/32	37	0.086	2	Green
OHSW-0104	1/4	45	0.086	2	Yellow
OHSW-0105	9/32	49	0.086	2	Blue
OHSW-0106	5/16	53	0.100	3	Black
OHSW-0107	3/8	62	0.119	3	Orange
OHSW-0108	7/16	72	0.138	3	Green
OHSW-0109	1/2	81	0.159	3	Blue
OHSW-0110	9/16	90	0.188	4	Yellow
OHSW-0111	5/8	103	0.204	4	Black
OHSW-0112	3/4	119	0.241	4	Orange
OHSW-0113	7/8	142	0.288	4	Green

For Aluminum-Clad Steel OHSW (left hand lay)

Catalog Number	OHSW Range Inches	Nominal Sizes(s)	Length Inches	Rod Diameter Inches	Number of Subsets	Color Code
OHSW-2102	.174-.181	3# 12	26	0.081	2	Orange
OHSW-2108	.219 - .220	3# 10	33	0.102	2	Green
OHSW-2110	.237 - .247	3# 9	34	0.102	2	Yellow
OHSW-2113	.270 - .280	3# 8	38	0.102	3	Blue
OHSW-2116	.303 - .313	3# 7	41	0.102	3	Black
OHSW-2119	.337 - .349	7# 9; 3# 6	45	0.114	3	Yellow
OHSW-2122	.380 - .394	7# 8; 3# 5	51	0.128	3	Orange
OHSW-2125	.427 - .442	7# 7	65	0.144	3	Green
OHSW-2128	.475 - .494	7# 6	72	0.162	3	Blue
OHSW-2129	.495 - .515	19# 10	74	0.162	3	Orange
OHSW-2131	.535 - .555	7# 5	78	0.162	3	Black



Optical Ground Wire Repair Rods

NOMENCLATURE

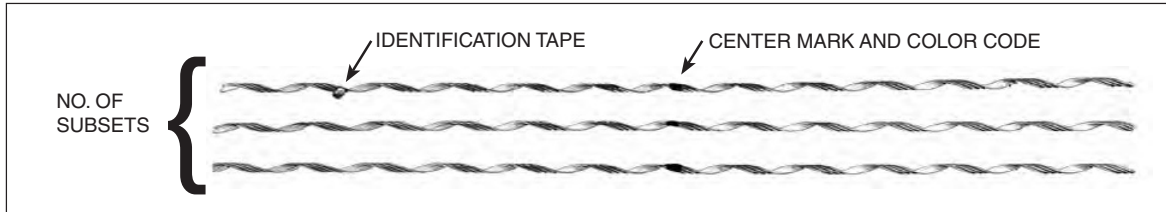

Subsets:

Individual aluminum clad steel rods assembled into groups. The bore is coated with conductive grit.

Color Code:

Provides identification for application of OPGW size that corresponds to tabular information appearing on catalog page.

Center Mark:

Establishes recommended alignment of rods during application.

Identification Tape:

Shows catalog number, nominal sizes.

GENERAL RECOMMENDATIONS

FIBERLIGN Repair Rods are designed as a single-component, outer layer assembly for use on OPGW and are intended for repair of the outer mechanical strand members on an OPGW cable. **This is not an optical repair product.**

These OPGW Repair Rods are not designed or tested as splices for use on all-metal overhead shield wire and are not intended for that application.

Restorative Repair:

These Repair Rods will provide varying levels of mechanical and electrical repair depending upon the specific construction, stranding and material of the OPGW.



The extent of mechanical damage that the product can repair for single layer OPGW is up to 50% of the cable rated strength. The 50% rating is established by PLP based on repair rod performance. Contact the OPGW cable manufacturer to verify the extent of damage that the specific cable design can survive without jeopardizing the performance of the fiber optic elements. If the cable manufacturer limits the repair level to less than 50%, limit the use of the repair rod to the lower level for that specific cable. Consult PLP for further details.

Lay direction of the Repair Rods should be the same as the outer strands of the OPGW. Left-hand lay is standard, consult PLP for right-hand lay designs.

Repair Rods					
Catalog Number	Diameter Range (inch)	Diameter Range (mm)	Length (inch)	Length (mm)	Color Code
3600100	.354-.385	9-10	45	1143	Red
3600101	.386-.422	10-11	48	1219	Black
3600102	.423-.460	11-12	50	1270	Orange
3600103	.461-.505	12-13	54	1372	Green
3600104	.506-.550	13-14	61	1549	Blue
3600105	.551-.602	14-15	65	1651	Yellow
3600106	.603-.660	15-17	70	1778	Brown
3600107	.661-.719	17-18	74	1880	Purple
3600108	.720-.785	18-20	80	2032	Pink
3600109	.786-.850	20-22	86	2184	Red
3600110	.851-.933	22-24	94	2388	Black
3600111	.934-1.020	24-26	102	2591	Orange

Left-hand lay standard



PREFORMED
LINE PRODUCTS

World Headquarters
660 Beta Drive
Cleveland, Ohio 44143

Mailing Address:
P.O. Box 91129
Cleveland, Ohio 44101

Telephone: 440.461.5200
Fax: 440.442.8816
Web Site: www.preformed.com
E-mail: inquiries@preformed.com

© 2017 Preformed Line Products
Printed in U.S.A.
EN-TM-1000-5
08.17.1H