

APPLICATION PROCEDURE & SAFETY CONSIDERATIONS **PREFORMED LINE PRODUCTS**

ARMOR-GRIP® Suspension



NOVEMBER 1996

Completely read and understand this procedure before applying product. Special attention should be given to the Safety Considerations located on the last page. We advise the reader to review those considerations now, and then again during the general review of this procedure.

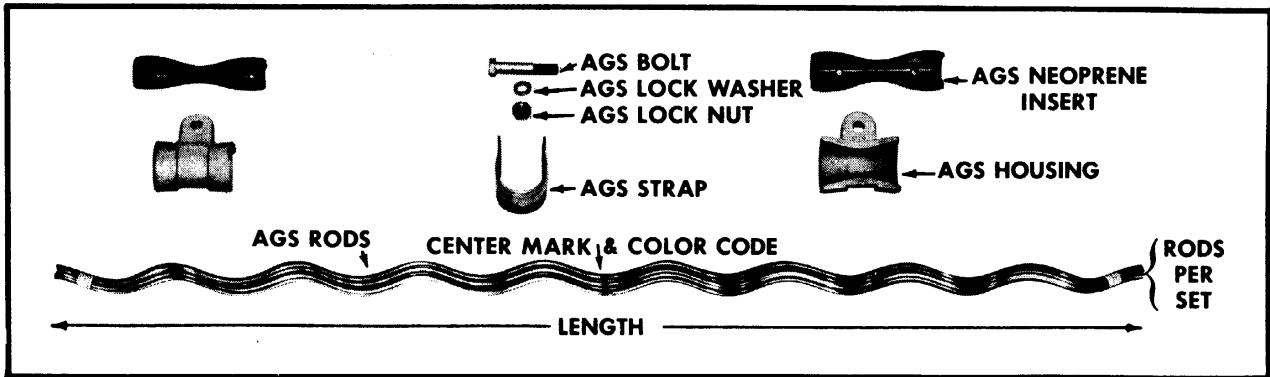

1. ARMOR-GRIP® Suspension nomenclature.



2. Plumb insulator string and mark conductor at center of sheave. Use felt marking pen or lumber crayon; do not scratch conductor. Lift the conductor beyond the ends of the rods to allow enough clearance for the application.

3. Align center marks of AGS Neoprene Inserts with center mark on conductor and tape in place with a thin layer of tape.

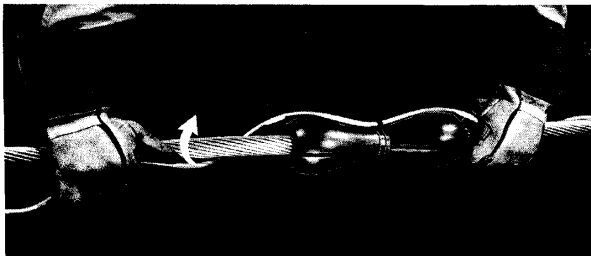

4. Center the AGS Rod on the insert. Apply sufficient length of rod (approximately two wraps) so that it will stay on the conductor.

DO NOT DISTORT RODS.

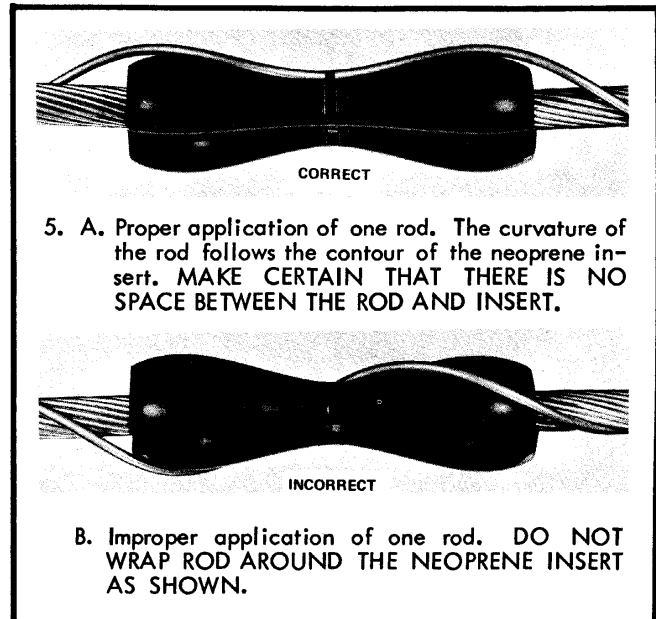

6. Apply all remaining rods evenly around neoprene insert. MAKE SURE THAT NO RODS ARE CROSSED. Each AGS Rod can be applied completely, or all rods can be applied partially as shown above. Make sure that all rod ends are snapped into place.

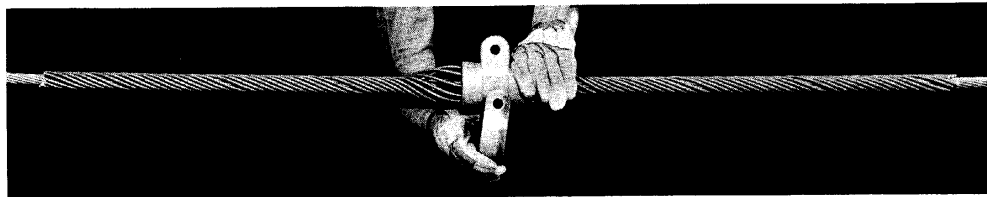

7. Place the two halves of the AGS Housing on either side of the center assembly. Slide the AGS Strap into position and with the heel of the hand tap firmly into place.

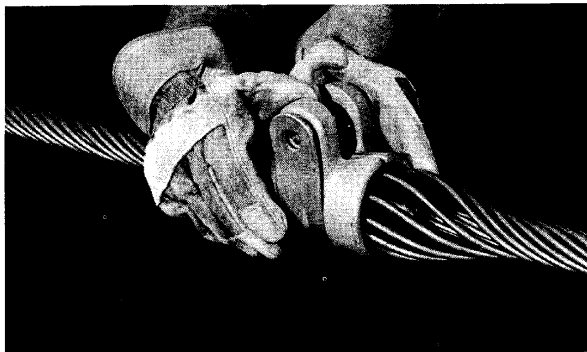

8. Spread the ears of the housing and tap strap into place again. This will align the holes so that the bolt may be inserted easily.

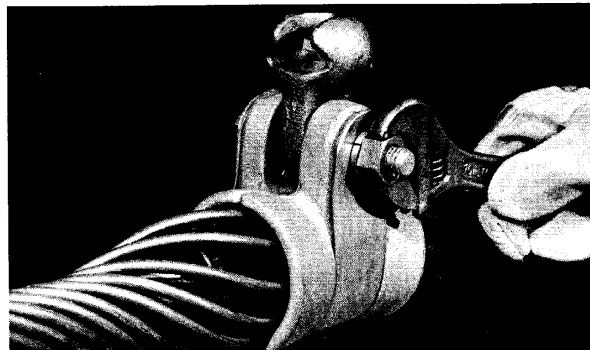

9. Tighten the nut until the lock washer becomes almost flat. DO NOT OVER-TIGHTEN. DO NOT SQUEEZE EARS OF AGS HOUSING AGAINST FITTING.

GENERAL NOTES

1. ARMOR-GRIP® Suspension Rods are precision devices. To insure a tight assembly, they should be stored and handled carefully. To prevent distortion and damage, they should be installed as illustrated.
2. ARMOR-GRIP® Suspension Rods are NOT interchangeable with standard Armor Rods.
3. On some sizes of ARMOR-GRIP® Suspension there will appear to be enough gap between rods to apply an additional rod... BUT... all AGS Rods are packed in sets. Apply only the number of rods in the set.
4. Maximum line angle of deviation:
 - a. The single support ARMOR-GRIP® Suspension may be used on line angles up through 30°.
 - b. Use the double support ARMOR-GRIP® Suspension for line angles between 30° and 60°. Consult the Factory for an engineering recommendation regarding this application.
5. ARMOR-GRIP® Suspension Rods are factory matched; do not intermix rods from different sets.
6. Do not reverse rods end to end in any one set; that is, do not flip end over end.
7. The alignment of the rods should be maintained within 2 inches for voltages of 230 KV and lower; for 345 KV and above, the alignment of the ends of the rods should be maintained within ¾-inch.

SAFETY CONSIDERATIONS

1. This application procedure is not intended to supersede any company construction or safety standards. This procedure is offered only to illustrate safe application for the individual. **CAUTION: FAILURE TO FOLLOW THESE PROCEDURES AND RESTRICTIONS MAY RESULT IN PERSONAL INJURY OR DEATH.**
 2. The rods of this product are intended for a single (one-time) use and for the specified application. However, the hardware components may be reused as desired if in good condition. **CAUTION: DO NOT REUSE RODS OR MODIFY THIS PRODUCT UNDER ANY CIRCUMSTANCES.**
 3. This product is intended for use by trained craftspeople only.
- This product **SHOULD NOT BE USED** by anyone who is not familiar with and trained in the use of it.
4. When working in the area of energized lines with this product, **EXTRA CARE** should be taken to prevent accidental electrical contact.
 5. For **PROPER PERFORMANCE AND PERSONAL SAFETY** be sure to select the proper size PREFORMED™ product before application.
 6. PREFORMED products are precision devices. To insure proper performance, they should be stored in cartons under cover and handled carefully.

PREFORMED LINE PRODUCTS 

P.O. Box 91129, Cleveland, Ohio 44101 • 440.461.5200 • www.preformed.com • e-mail: inquiries@preformed.com

SP2062-1

Litho in U.S.A.

NOTES

1. ALL DIMENSIONS IN MILLIMETRES.
2. TOLERANCES UNLESS OTHERWISE STATED:-
 - a. HOLE DIAMETRE ±0.5mm
 - b. LINEAR DIMS. UP TO 30mm ±1.5mm
 - c. LINEAR DIMS. OVER 30mm ±5% UP TO A MAX. OF 5mm.
3. BRACKETED DIMENSIONS DO NOT AFFECT INTERCHANGEABILITY OR COUPLING AND ARE FOR GUIDANCE ONLY.
4. MATERIAL TO AS1154 GALVANIZING TO AS/NZS 4680
5. IDENTIFICATION MARKINGS:- AS SHOWN

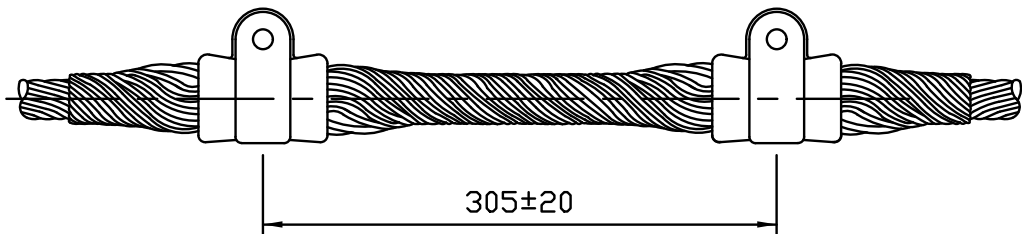

ITEM	PART No.	DESCRIPTION	REQ.D	MATERIAL
1	AGSH-60234-18	AGS HOUSING	4	ALUM. ALLOY
2	AGSS-65051-18	AGS STRAP	2	ALUM. ALLOY
3	AGSR-5804	AGS RODS Ø4.62	10/SET	ALUM. ALLOY
4	AGNI-55003	AGS INSERT	4	NEOPRENE
5	GCB-16093	M16 BOLT	2	GAL. STEEL
6	GHN-16-8	M16 NUT	2	GAL. STEEL
7	GSW-16	M16 SPRING WASHER - GAL	2	GAL. STEEL
8	SP-HPA	SPLIT PIN - HUMPBACK	2	STAIN. STEEL

Ø14.3	7/4.75 AAAC	BLACK	IODINE
Ø	STRANDING	AGS COLOUR CODE	NAME
CONDUCTOR DETAILS			

DOUBLE ROD LENGTH=1450±100

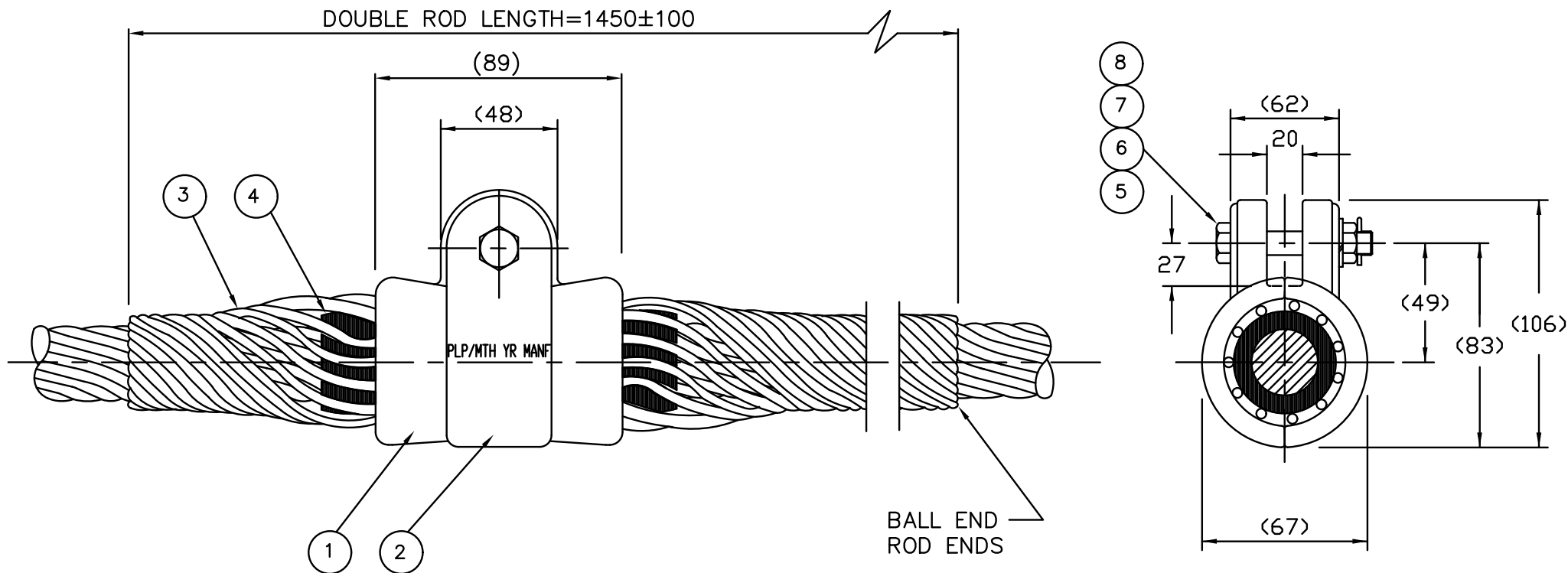

A	T	D	17/02/94	B	CC	08/06/05
CHK	DM	18/02/94	CHK			
INITIAL ISSUE		A6796				
DSC NO.A0282						

THIS DRAWING IS THE EXCLUSIVE PROPERTY OF PREFORMED LINE PRODUCTS (AUSTRALIA). REPRODUCTION THEREOF IS PROHIBITED AND IS TO BE USED ONLY WITH THE EXPRESSED PERMISSION OF THE COMPANY

PART No: AGS-5804	
ARMOR GRIP SUSP	
RANGE: 14.10 - 14.59	
PASSED	DATE



PREFORMED LINE PRODUCTS (AUSTRALIA) PTY. LTD.

SCALE	N.T.S.	DRAWING NUMBER	023-088-RD
-------	--------	----------------	------------

ARMOR-GRIP Suspension



General Recommendations

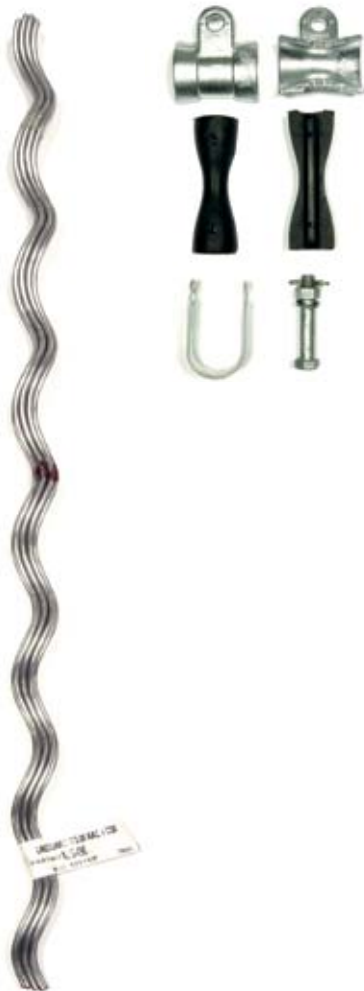

The Preformed Armor-Grip Suspension unit is intended for use on all material types and conductor constructions. Designed to reduce the static and dynamic stresses at the support point so that the conductor is protected against the effects of conductor motion. It also protects the conductor in the support area against impulse and power flash-over arcing.

The Preformed Armor-Grip Suspension is superior to bolted alternating combinations for protecting conductors from bending, compression stress and abrasion.

Line Repairs:

Where a conductor has been damaged by a bolted clamp, The Preformed Armor-Grip Suspension can be used in the repair. All Armor-Grip Suspensions can be applied over Preformed type armor rods to restore and extend the life of the conductor.

Line Angle:

The maximum recommended line angle for a single support AGS is 30°. For angles between 30° and 60°, the Armor-Grip Suspension Double Assembly is recommended.

For Application Procedures, visit the PLP website.
www.preformed.com.au

SAFETY CONSIDERATIONS

- This product is intended for a single (one-time) use and for the specified application, although it may be re-applied twice for retensioning within 90 days from initial installation.
- Do not modify this product in any way.
- This product is intended for use by qualified linesmen only.
- When working in the area of energised line with this product, extra care should be taken to prevent accidental electrical contact.
- For proper performance and personal safety, be sure to select the proper size PREFORMED™ products before application.
- PREFORMED™ products are precision devices. To ensure proper performance, they should be stored in cartons under cover and handled carefully.

ARMOR-GRIP Suspension



AGS 8 Series for AAC, AAAC, ACSR



Part Number (Single Unit)	Part Number (Double Unit)	Conductor Diameter Range (mm)	Colour Code
AGS-8097	AGS-8797	6.90 - 7.19	Blue
AGS-8098	AGS-8798	7.20 - 7.49	Red
AGS-8099	AGS-8799	7.50 - 7.69	Blue
AGS-8100	AGS-8800	7.70 - 7.99	Brown
AGS-8101	AGS-8801	8.00 - 8.29	White
AGS-8102	AGS-8802	8.30 - 8.69	Orange
AGS-8103	AGS-8803	8.70 - 8.99	Black
AGS-8104	AGS-8804	9.00 - 9.49	Red
AGS-8105	AGS-8805	9.50 - 9.89	Orange
AGS-8106	AGS-8806	9.90 - 10.29	Blue
AGS-8107	AGS-8807	10.30 - 10.59	Brown
AGS-8108	AGS-8808	10.60 - 10.99	Green
AGS-8109	AGS-8809	11.00 - 11.39	Black
AGS-8110	AGS-8810	11.40 - 11.89	White
AGS-8111	AGS-8811	11.90 - 12.19	Green
AGS-8112	AGS-8812	12.20 - 12.80	Blue

Note: 80 and 81 are single units, 87 and 88 are double units, 8 Series use a 16 mm bolt and a pressed metal housing with aluminium rods.

Double AGS Suspension is used where the turning angle is greater than 30° and up to 60°. A triangular Yoke Plate is used with Double AGS.



ARMOR-GRIP Suspension

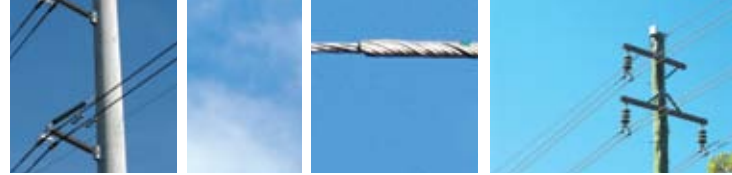

AGS 5 Series AAC, AAAC, ACSR



AGS-51

Part Number (Single Unit)	Part Number (Double Unit)	Conductor Diameter Range (mm)	Colour Code
AGS-5102	AGS-5802	13.48 - 13.77	Green
AGS-5103	AGS-5803	13.78 - 14.09	Brown
AGS-5104	AGS-5804	14.10 - 14.59	Blue
AGS-5105	AGS-5805	14.60 - 15.09	Red
AGS-5106	AGS-5806	15.10 - 15.39	Orange
AGS-5107	AGS-5807	15.40 - 15.79	Purple
AGS-5108	AGS-5808	15.80 - 16.39	Orange
AGS-5109	AGS-5809	16.40 - 17.09	Black
AGS-5110	AGS-5810	17.10 - 17.59	Blue
AGS-5111	AGS-5811	17.60 - 18.09	Yellow
AGS-5112	AGS-5812	18.10 - 18.59	Black
AGS-5113	AGS-5813	18.60 - 19.09	Black
AGS-5114	AGS-5814	19.10 - 19.59	White
AGS-5115	AGS-5815	19.60 - 20.19	Orange
AGS-5116	AGS-5816	20.20 - 20.99	Brown
AGS-5117	AGS-5817	21.00 - 21.49	Red
AGS-5118	AGS-5818	21.50 - 22.09	Blue
AGS-5119	AGS-5819	22.10 - 22.69	Green
AGS-5120	AGS-5820	22.70 - 23.09	Orange
AGS-5121	AGS-5821	23.10 - 23.39	Yellow
AGS-5122	AGS-5822	23.40 - 23.79	Black
AGS-5123	AGS-5823	23.80 - 24.39	White
AGS-5124	AGS-5824	24.40 - 25.09	Purple
AGS-5125	AGS-5825	25.10 - 25.54	Orange
AGS-5126	AGS-5826	25.55 - 25.99	Purple

For use on: ACSR, AAC, AAAC compacted all aluminium and compacted ACSR. Conductors above 12.8 mm in diameter. Right-hand lay standard. 51 Series are single, 58 Series are double.

Note: Contact PLP for required bolt size. Available in M16, M18 and M20

Double AGS Suspension is used where the turning angle is greater than 30° and up to 60°. A triangular Yoke Plate is used with Double AGS.



AGS-58