



A **PREFORMED** LINE PRODUCTS COMPANY



FiberRoad

20  
/  
21

# PRODUCT CATALOGUE



OPTICAL DISTRIBUTION BOXES



DATA CABINETS

micostel.com

30

ANNIVERSARY  
1990-2020

# SOLUTIONS for METROPOLITAN network

## WIDE RANGE OF PRODUCT PORTFOLIO

FROM HIGH STANDARD  
TO ORIGINAL  
CLIENT SOLUTIONS

**MICOS Telcom** based in Czech Republic focuses on development and production of solutions for telecommunications and data networks. As of April 1st, 2019 MICOS Telcom partnered with **Preformed Line Products (PLP)**, a worldwide designer, manufacturer and supplier of fiber optic and copper splice closures, high-speed cross-connect devices and high-quality cable anchoring/control hardware, established in 1947. Together the combined forces of PLP and MICOS Telcom have strengthened their position as one of the worlds leading suppliers of passive elements for optical networks and critical infrastructure. Our global team **now operates facilities in 19 different countries, supporting customers in over 140 different countries.**

The following MICOS Telcom portfolio contains **more than 1000 items**, each developed and produced in the EU. We strive to fully optimize solutions to meet the high standards our global telecommunications and power distribution customers expect. Look for future catalogues which will contain the combined product offering of our expanded product line. For product details online, visit [www.micostelcom.com](http://www.micostelcom.com) or [www.preformed.com](http://www.preformed.com)





## **SOLUTIONS AND PRODUCTS**

MICOS TELCOM offers a convenient connection of integrated solutions with a wide range of compatible products for builders and operators of data and telecommunications networks.

## **MICOS TELCOM PRODUCT PORTFOLIO**

- Optical distribution boxes
- Street cabinets
- ODF's & ODB's
- Optical closures
- Overground pillars
- High density cabinets
- Racks and data cabinets
- Optical mini sockets & modules
- Optical accessories (glands, splice trays, splitters etc.)



## **INNOVATIONS, DEVELOPMENT, MANUFACTURING, SERVICES**

An important benefit for our customers is a concentration of research and development located together with our own production facility. We are able to offer special and completely new technical solutions according to customer's requirements, from product development and prototyping to testing and putting into operation.

Our production facility exploits modern technological equipment for metal and plastics processing, as well as long-standing expertise of skilled workers.

Not only manufacturing of the boxes can be offered but the range of services can be extended by assembling optical distributors i.e. mounting of optical connectors with pigtailed and fiber optic bundling.



## **WHAT WE OFFER? WHY TO COOPERATE?**

- Completing your portfolio of products and gain competitive advantage with MICOS unique and fully certified products.
- Direct cooperation with a renowned producer, which has its own development department.
- Production capacity for manufacturing of all production range parts and unit production of prototypes and samples.
- Flexibility to solve specific requirements and possibility to develop completely new tailor-made products exactly according to given specifications.
- Know-how, technical consultation, assistance and support for project of any scope.

### SOLUTIONS for METROPOLITAN network



1. **ORM 4**  
Module ODF

2. **ORM 2**  
High density cabinet

3. **ORU 1 MUC**  
Underground chamber

4. **MUC 315**  
Underground chamber large

5. **ORU 8 SDF SIS**  
Fiber distribution Hub (FDH)

6. **ORM 16 SDF SIS**  
Fiber distribution pillar

7. **ORU 3 SIS**  
Fiber distribution pillar

8. **URM SH 48S**  
Wall mounted optical distribution box

9. **MUC 250 SL 24 S**  
Underground chamber medium

DISTRIBUTION BOX	INDOOR USE	OUTDOOR USE	MAX. CAPACITY OF OPTICAL SPLICES	MAX. CAPACITY OF OPTICAL CONNECTORS SC/LC	PAGE
<b>▶ OPTICAL DISTRIBUTION BOXES FOR INDOOR OR OUTDOOR USE</b>					0 10–0 xx
ORM 1	●		4	2/4	0 10
ORM 2	●		6	2/4	0 11
COYOTE® FTP	●		4	2/4	0 11
MTeH MINI	●		14	10/20	0 12
MTeH EASY	●		24	12/24	0 14
MTeH UNI	●		48	24/48	0 16
ORM 3 FA	●	●	12/24/36		0 20
ORM 3 L/2 / ORM 3 L/4	●	●	12/12	2/4 / 4/4	0 21
ORM 3 SL 12S / ORM 3 SH 24S	●	●	12/24		0 21
RISER KABEL	●	●			0 23
ORM 4 / ORM 8	●	●	6/12	4/4 / 8/8	0 24
ORM 5	●	●	12	4/8	0 25
COYOTE® STP – JR					0 26
COYOTE® STP – MD					0 27
URM SL 12C / URM SL 12C M	●	●	12/12	12/12	0 28
URM SH 24C / URM SH 24C M	●	●	12	12	0 29
URM SH 48S	●	●	24/48		0 29
URM LL 24C M	●	●	12/24	12/24	0 29
URM LL 48S	●	●	48/96/144		0 29
URM LH 48C M	●	●	24/48/72	24/48	0 30
URM LH 48C UNI	●	●	24/48/72	24/48	0 30
URM LH 16 SDF	●	●	24	16/16	0 30
URM LH 96S	●	●	48/96/144		0 31
URM LH 144S	●	●	48/96/144		0 31
ORM 16 SDF / ORM 16 SDF SIS	●	●	24	18/18	0 32
SNM 48 SIS / SNM 72 VS SIS / SNM 144 VS SIS	●	●	48/72/144		0 33
MDP OZ 144/288/432S		●	144/288/432		0 34
MDP OZ 24/48, MDP OZ 48/96, MDP OZ 72/144		●	96/192/288	24/48/96 / 72/144	0 35
ORM 96/144 F	●	●	144	96/144	0 36
MDB FA 144/192/288S	●	●	144/192/288		0 37
MDB FA 24/48, MDB FA 48/96, MDB FA 72/144	●	●	48/96/144	24/48 / 48/96 / 72/144	0 38
MODB 48	●		48	48	0 39
POR 48	●		48	24/48	0 39
ORU 1, 2, 3 / ORU 1, 2, 3 SIS	●	●	144 / 576 / 864		0 40
ORU 1 SDF SIS / ORU 5 SDF SIS	●	●	128/384	64/288	0 41
ORU 9 SDF SIS	●	●	288	144/288	0 42
ORU 9D SDF SIS	●	●	600	300/612	0 43
ORU 8 SDF SIS	●	●	504/1008	480/960	0 44
FDH 288 / FDH 288 SIS	●	●	624	312/624	0 45
FIBREGUARD™					0 46
SAFeTNET					0 47
MUC 160 / MUC 250		●	12 / 24		0 50
MUC 315B		●	96	18/36	0 51
MUC 425B		●	192		0 52
MUC 600B		●	384		0 52
ACCESSORIES FOR UNDERGROUND CHAMBER					0 53
MUC CUBE 320		●			0 54
MUC 400		●			0 55
MUC600		●			0 56
<b>▶ OPTICAL DISTRIBUTION BOXES FOR DATA CABINETS</b>					0 57–0 62
ORMP 1U/2U	●		24/48	24/48	0 57
ORSM 4/6	●		72/144 / 36/72	72/144	0 58
Splitter panel 1U/2U	●			37/65	0 59
ORMPV 1U/2U/3U	●		36/96		0 60
ORMPM 3U/144	●		144	144/ –	0 61
ACCESSORIES for ORMPM					0 62
<b>▶ HIGH-CAPACITY OPTICAL DISTRIBUTION BOXES</b>					0 63–0 70
ORSM 1 / ORSM 2	●		864	864/1728	0 63
ORS 1/300 / ORS 1/600	●		1920	1920/ –	0 64
ORS 2/300 / ORS 2/600	●		960	960/1920	0 64
ACCESSORIES for ORS					0 66
ORSL EE	●		3168	2112/3168	0 67
ORSL AP 300 / ORSL AP 600	●				0 68
MNORS	●	●	480/672	480/672	0 69
rDSLAM 450M / rDSLAM 900D		●			0 70
<b>▶ MICRO DUCT SYSTEM</b>					0 71
<b>▶ CUSTOMER SOLUTIONS</b>					0 72
<b>▶ ACCESSORIES   ▶ FIBEROAD   ▶ UNIVERSAL ACCESSORIES   ▶ ACCESSORIES FOR ORM 1</b>					0 73–0 85
<b>▶ PREVIOUS GENERATION OF MICOS BOXES</b>					0 86–0 89
ORM 24   ORM 24 VS   ORM 12(24) SIS, ORM 24 VS SIS   ORU 1 MUC					0 86
SOP 36 VS   ORU 6 MRS   POR 12   ORMPTR 1.5U/2U					0 87
ORM SNP 4U   ORM 32 SDF, ORM 32 SDF SIS   SOP 12 (24)   MEDIA BOX					0 88
HDC 480/864   ORM 48/72/96 VSR, ORM 48/72/96 VSR SIS   SNM 288 VS, SNM 288 VS SIS					0 89
<b>▶ CLEAN ASSEMBLY ROOM</b>					0 90
<b>▶ EXAMPLES OF INSTALLATIONS</b>					104–106

# FTTH RISER SOLUTION WITH FLOOR BOX | INDOOR SOLUTION

Using the Riser cable as a vertical distribution in the buildings is nowadays one of the most popular ways of constructing FTTH, and namely due to its easy installation. It is that simple cutting out working windows on the cable in the places where necessary and then pulling out the fibers.

In FTTH RISER solution based on floor distribution boxes, after installing one cable to 12 apartments, 12 fibers are terminated on SC/APC adapters. Connecting customers then goes very quickly, without the necessity of splicing, just by mere placing a patchcord between the floor box and the customer's premises.

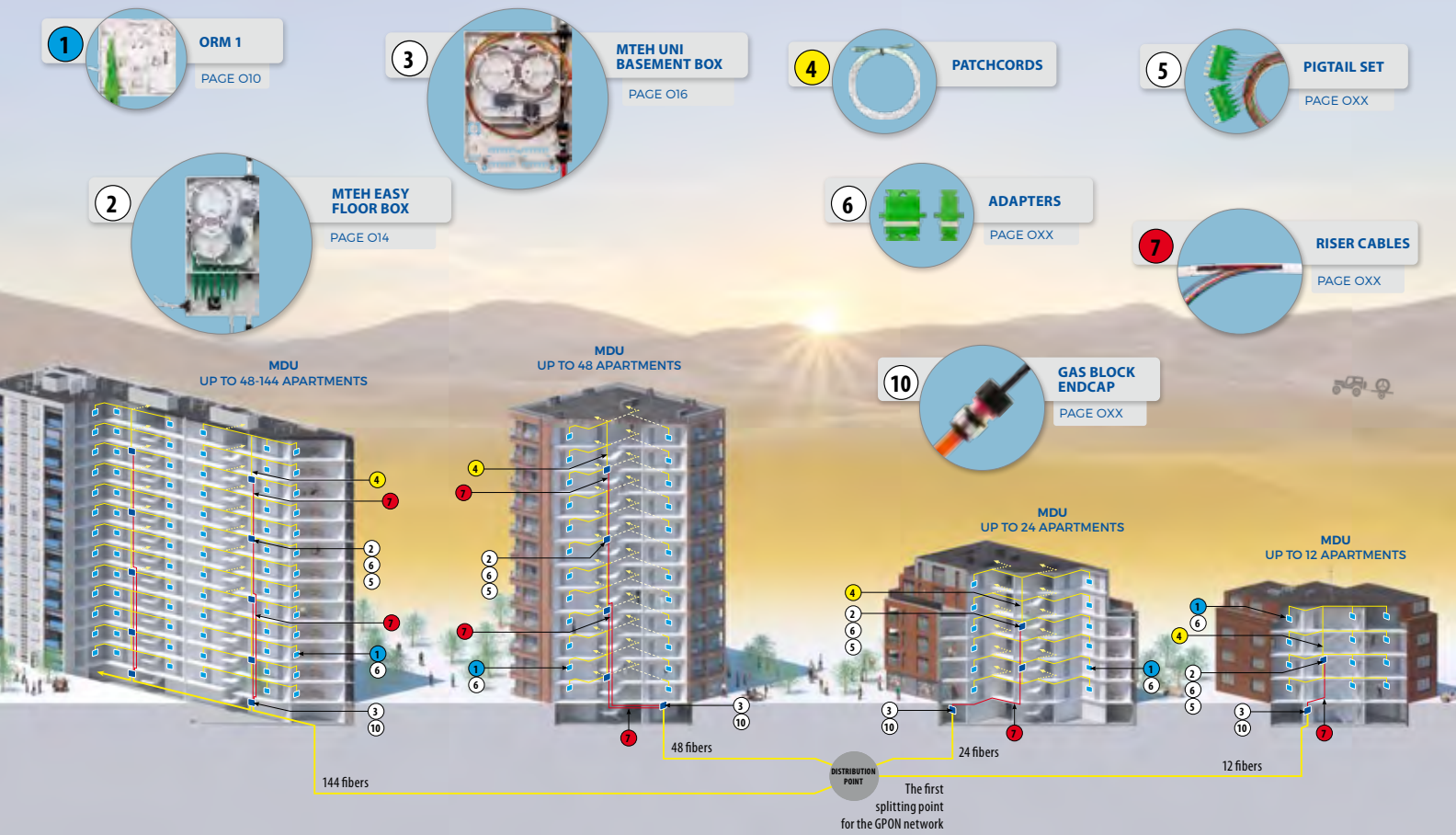

## ▶ PRODUCTS IN THE SOLUTION

Name	Catalog page
ORM 1	Page 010
MTeH EASY	Page 014
MTeH UNI	Page 016
Patchcords, pigtails and adapters	Page Oxx
Riser cable	Page Oxx
Gas block	Page Oxx

## ▶ YOU CAN SEE DETAIL SOLUTION IN THE WEBSITE

▶ <https://www.micostelcom.com/micos-ftth-riser-solution-with-floor-box>



INTERACTIVE PDF

# FTTH GPON SPLICELESS SOLUTION | INDOOR SOLUTION

GPON is one of the most used technologies in FTTH networks, it is so due to the effective use of fibers and ports of the active equipment. GPON networks today allow achieving the splitter ratio of 1:128 and splitting in two, sometimes in three points of the network.

FTTH GPON spliceless solution from MICOS gives an idea of designing the inbuilding distribution network structure by means of floor boxes without the necessity to splice the fibers. The inbuilding optical distribution network can be built without the need of the qualified labour force and the expensive equipment

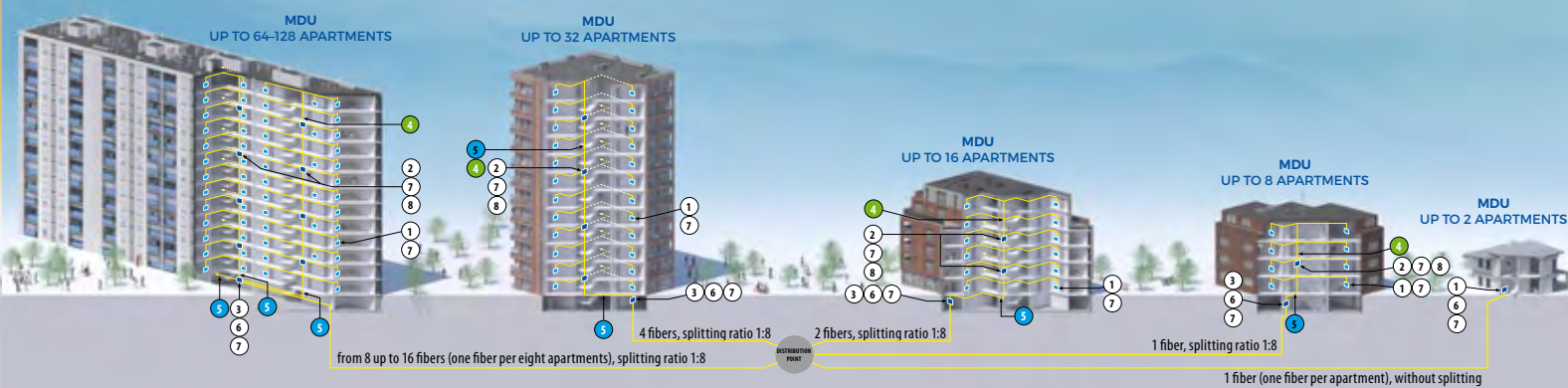
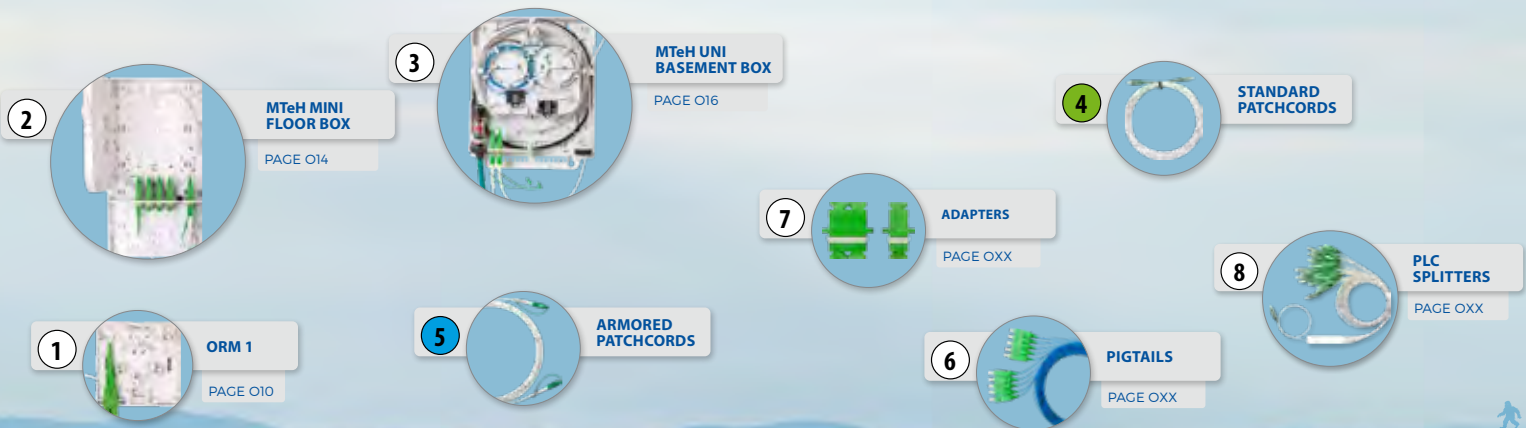

## ▶ PRODUCTS IN THE SOLUTION

Name	Catalog page
ORM 1	Page 010
MTeH MINI	Page 014
MTeH UNI	Page 016
Pigtails, adapters and splitters	Page Oxx

## ▶ YOU CAN SEE DETAIL SOLUTION IN THE WEBSITE

▶ <https://www.micostelcom.com/micos-ftth-gpon-spliceless-solutions>



INTERACTIVE PDF

# FTTH FACADE SOLUTION | OUTDOOR SOLUTION

FTTH facade solution offers a way of a simple installation of the optical infrastructure which fully eliminates construction works inside the buildings. The solution is suitable especially for two-storey houses.

ORM 3 FA can be used both for splicing the feeder cable and gradual connecting the subscribers. The horizontal cable distribution is being installed on the facade by using cable clips. This cable is being worked the same way like a standard riser cable inside the buildings.

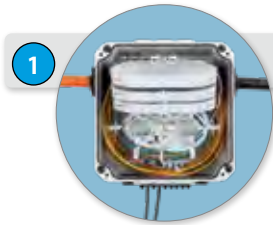

**1** ORM 3 FA TRANSITION BOX  
PAGE OXX

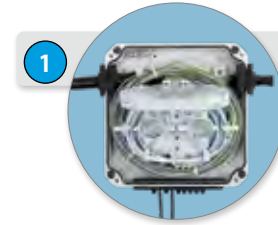

**1** ORM 3 FA END BOX  
PAGE OXX

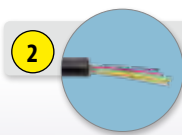

**2** FACADE CABLES  
PAGE OXX



**3** DROB CABLES

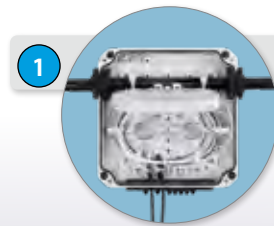

**1** ORM 3 FA DISTRIBUTION BOX  
PAGE OXX



**4** OUTDOOR CLIPS

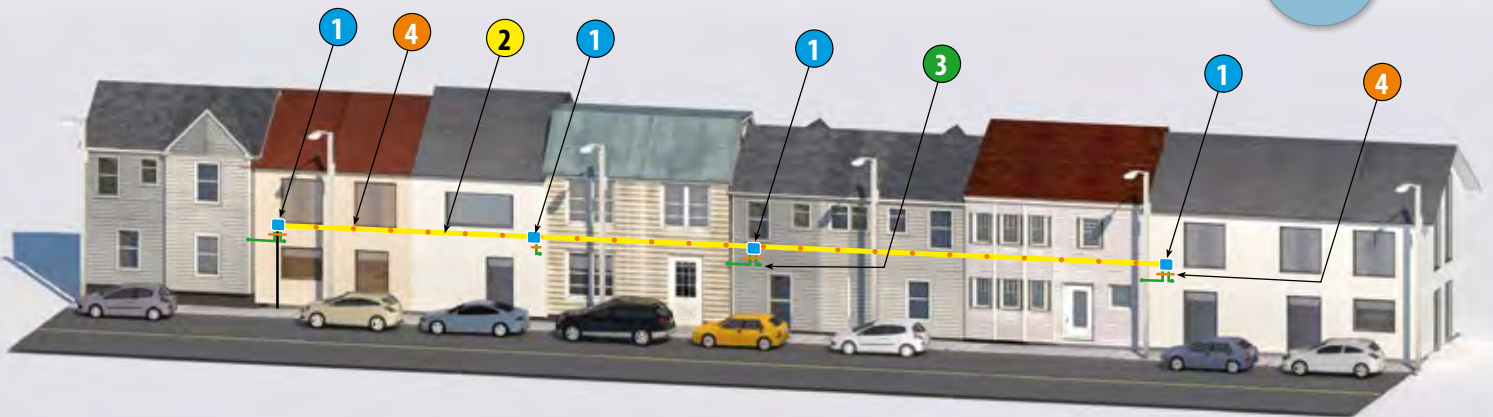

## ▶ PRODUCTS IN THE SOLUTION

Name	Catalog page
ORM 3 FA	Page Oxx
Facade cables	Page Oxx

## ▶ YOU CAN SEE DETAIL SOLUTION IN THE WEBSITE

▶ <https://www.micostelcom.com/micos-ftth-facade-solution>



INTERACTIVE PDF



The installation of the network under the ground is among the most widely used solutions in the construction of FTTx networks, especially for its durability and invisibility. Duct systems are used for the construction as they facilitate the construction itself and the subsequent installation of cables. The blowing of the cables can be performed gradually and modified according to the network requirements with no additional costs of ground work. At the network distribution points, there are ground chambers installed with boxes allowing connection of fibres in various configurations.

Micos FTTx underground solution offers a comprehensive approach to the mutual compatibility of all elements in the network. It shows the use of the chambers, ducts and cables on actual examples of the connection of the central office from the metropolitan network, to large housing units or family houses. The solution is intended for operators, installers and designers who can use it as a model when designing a network.

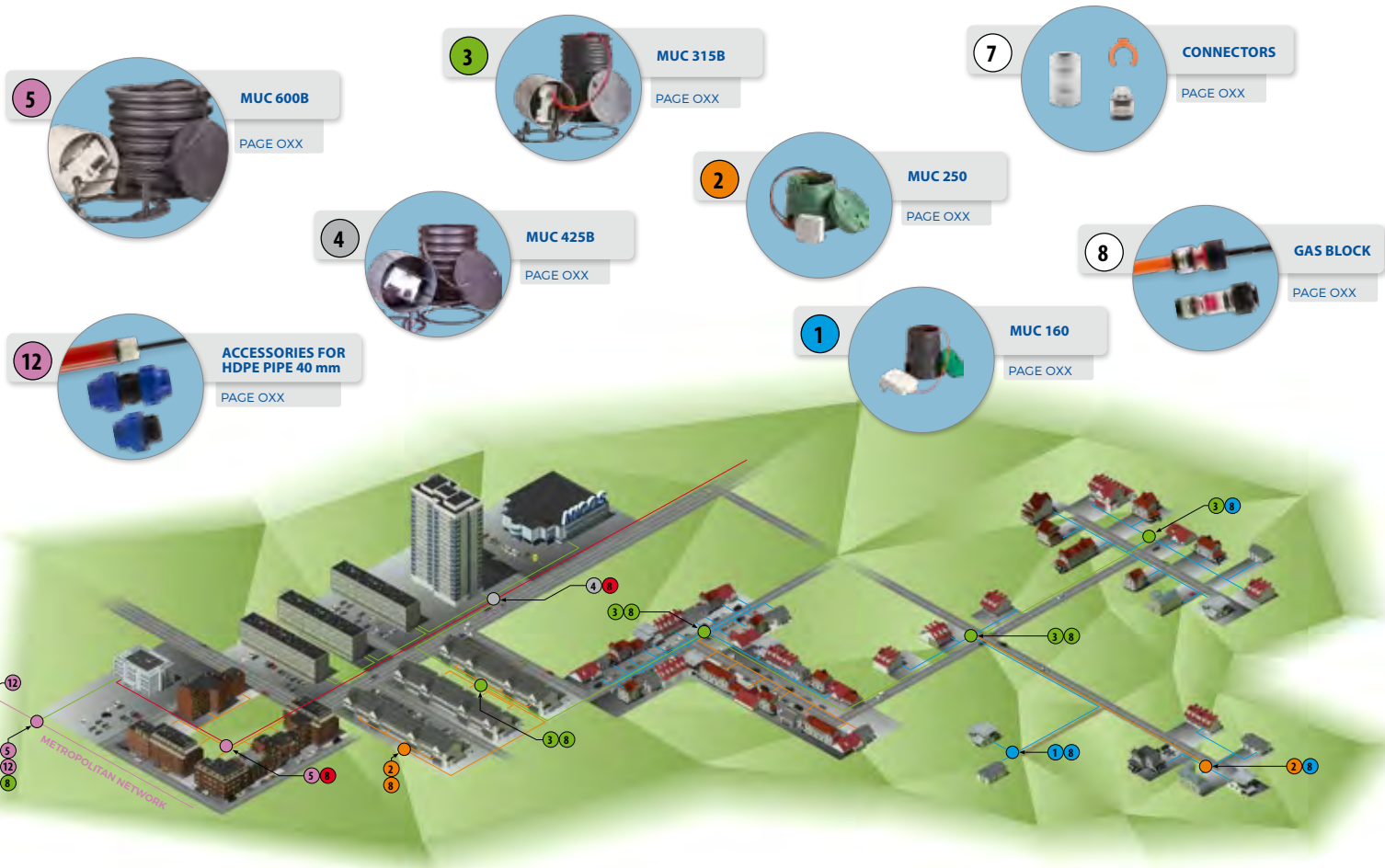

**5** **MUC 600B**  
PAGE OXX

**3** **MUC 315B**  
PAGE OXX

**7** **CONNECTORS**  
PAGE OXX

**4** **MUC 425B**  
PAGE OXX

**2** **MUC 250**  
PAGE OXX

**8** **GAS BLOCK**  
PAGE OXX

**12** **ACCESSORIES FOR HDPE PIPE 40 mm**  
PAGE OXX

**1** **MUC 160**  
PAGE OXX

### PRODUCTS IN THE SOLUTION

Name	Catalog page
MUC 600 B	Page 010
MUC 425 B	Page 014
MUC 315 B	Page 016
MUC 250	Page Oxx
MUC 160	Page Oxx
Gas block, connectors and accessories	Page Oxx

### YOU CAN SEE DETAIL SOLUTION IN THE WEBSITE

▶ <https://www.micostel.com/micos-fttx-underground-solutions>



INTERACTIVE PDF

FibeRoad system is designed for optical fiber networks of all types. For the use in distribution boxes, street cabinets or high capacity cabinets. It allows for all configurations of fiber distribution and direct patching within the stacking system. Ideal for GPON networks.

The FibeRoad solution provides the review of all items of the system and products, in which it is installed. The solution shall serve as directions to product descriptions with detailed information.

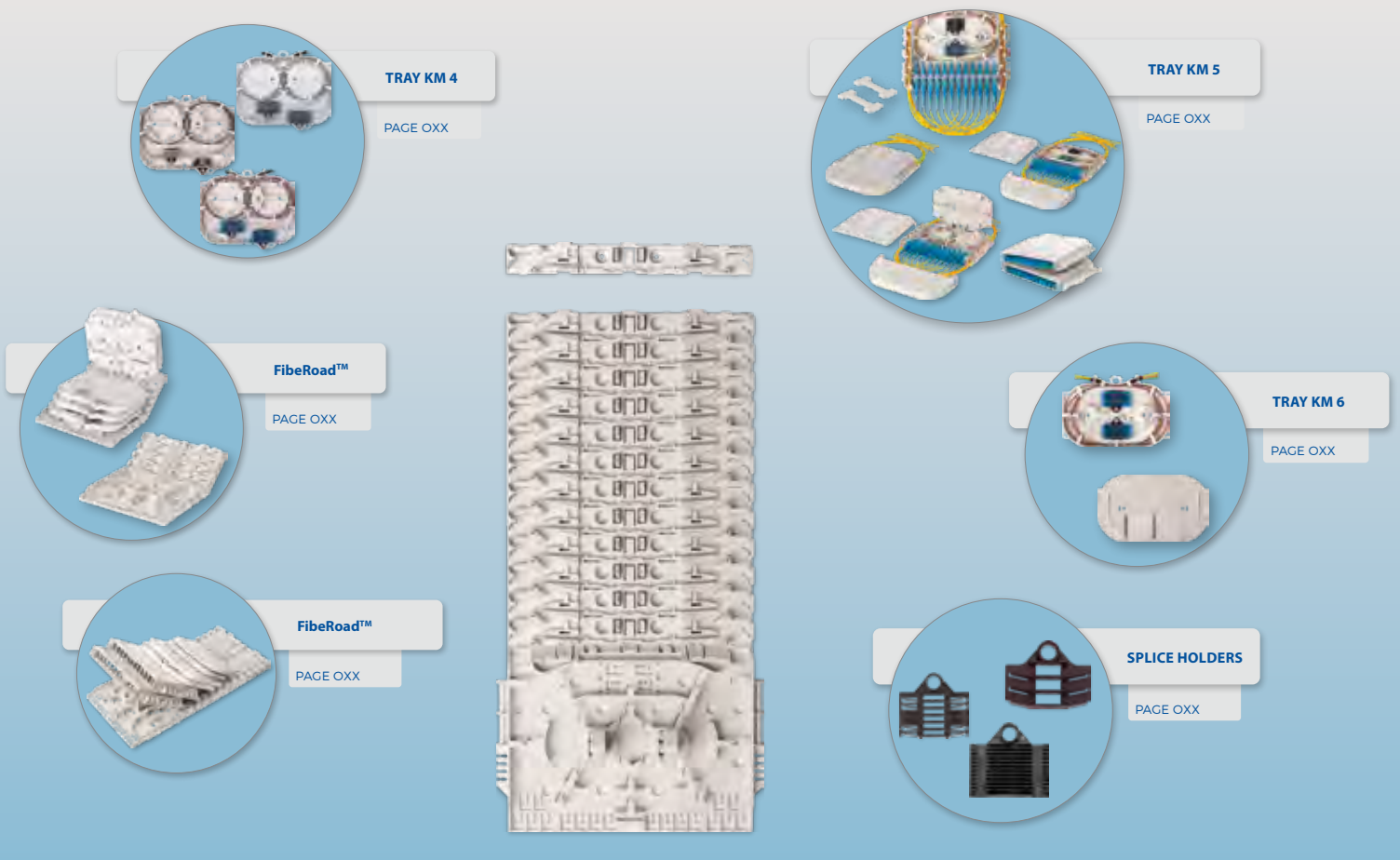

### ▶ PRODUCTS IN THE SOLUTION

Name	Catalog page
FibeRoad™	Page 0xx
Tray KM 4	Page 0xx
Tray KM 5	Page 0xx
Tray KM 6	Page 0xx
Splice holders	Page 0xx

### ▶ YOU CAN SEE DETAIL SOLUTION IN THE WEBSITE

▶ <https://www.micostelcom.com/micos-fiberoad-solution>



INTERACTIVE PDF

The optical socket ORM1 is designed for termination of an optical network via 2–4 optical fibers in a customer terminal point. It can be connected to a PC, different peripheral equipment or to another equipment via optical patchcords. It is designed for indoor wall mounting.

- ▶ Capacity of 4 optical connectors
- ▶ Connector holder SC simplex or LC duplex
- ▶ Maximum capacity is 4 optical splices, heat shrink, RECORD splice, Fiberlock
- ▶ Attractive design for indoor usage
- ▶ Installing on a surface or flush-mounting box
- ▶ Simple optical management
- ▶ Direct fiber termination by a connector
- ▶ Standard socket dimensions
- ▶ Input possibility of fiber with connector
- ▶ Use for fibers G.657
- ▶ Possibility of pre-assembled ftth socket to minimize installation time at the customer (cable FLAT DROP 2 × 3.1 mm)

### TECHNICAL SPECIFICATIONS

Inputs	From all sides or from the bottom part, diameter up to 6 mm
Outputs	From the front for 2 pcs of SC or LC adapters
Coverage degree	IP 30 or IP 54 (with rubber enclosure) to EN 60529
Colour	White RAL 9003
Material	ABS
Dimensions	81 × 81 × 25 mm with short cover 81 × 116 × 25 mm with extended cover
Weight	0,08 kg (short and extended cover)

### RECOMMENDED ACCESSORIES

Other accessories on the pages 074

### ORDER CODES

Order Code	Name
85H4.00/0000F	ORM 1 (with short and extended cover)
On request	FTTH ORM 1 Pre-assembled

For other variants, please, contact our sales department.  
Pre-installed versions available upon request.

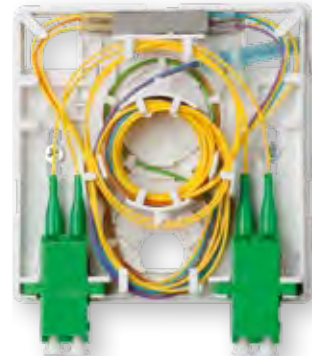

### TECHNICAL SPECIFICATIONS CABLE

Dimensions	2 mm × 3.1 mm
Strength member	Steel/FRP/KFRP
Material	Flame retardant polyethylene
Color	White
Maximum pulling tension (IEC794-1)	Long time 30N , Short time 60N
Crush resistance (IEC794-1)	Long time 300N , Short time 1000N
Temperature operation and storage	-20°C to +60 °C
Weight	8 kg/km



▶ The ORM 2 is designed for the termination of 2 to 4 optical fibers in a customer terminal point or for interconnection of optical cables. It can be connected to a PC, different peripheral equipment or to another equipment via optical patchcords. The distributor is designed for indoor wall mounting. Inputs and outputs can vary by used panels.

- ▶ Capacity 4 optical connectors
- ▶ Connector holder SC simplex, SC duplex, ST, FC, E2000, LC
- ▶ Maximum capacity is 6 optical splices
- ▶ Direct fiber termination by a connector
- ▶ Easy assembly
- ▶ Wall-mounted
- ▶ Coverage degree IP 20
- ▶ Use for fibers G.652d, G.657

### ▶ TECHNICAL SPECIFICATIONS

Inputs	Micro duct ø 5 mm Micro duct ø 3 mm Optical cable maximum ø 5 mm
Outputs	Adapters SC simplex, SC duplex, ST, FC, E2000, LC
Coverage degree	IP 20 to EN 60529
Impact protection degree	IK 04 to EN 50102
Colour	Light grey RAL 7035
Material	ABS
Dimensions	140 × 109 × 23 mm
Weight	0.1 kg



### ▶ ORDER CODES

Order Code	Name
8523.20/0000F	ORM 2

Pre-installed versions available upon request.

▶ NEW

▶ The Fiber-Optic Terminal Point - FTP is designed for protecting and accommodating internal fiber optic splices in homes, offices or apartments. The FTP is designed for indoor wall mounting and it is easily installed on walls without the use of special tools.

- ▶ Capacity of 2 adapters for subscriber output and 5 drop wire inputs
- ▶ Capacity of 2 splices in tray (by mechanical or fusion)
- ▶ Designed for pre-connectorized system to store fiber jumper
- ▶ Fiber inputs ports through the back of the base
- ▶ Can be easily installed on any flat vertical wall
- ▶ The tray design allows for perfect routing and control of fibers
- ▶ Use for fibers G.652d, G.657

### ▶ TECHNICAL SPECIFICATIONS

Inputs	3 × max. 5 mm
Outputs	2 × SC or LCD adapters
Colour	White
Material	ABS
Dimensions	108 × 80 × 28 mm
Weight	0.09 kg

### ▶ ORDER CODES

Order Code	Name
On request	FTP



# RISER CABLE

## INDOOR OPTICAL CABLE

Riser cable is installed in vertical shafts inside buildings with multiple floors. Window cut on the riser cable is needed on each floor. Take out requested fiber from the cable and then pull the fiber through the transportation tube 5/3,5 with the rope directly to customer premises when service is required.

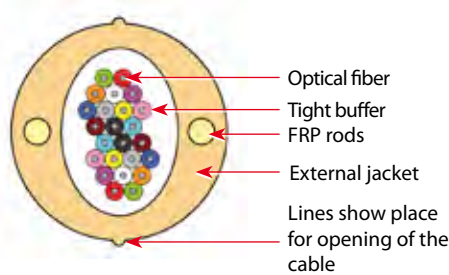

### TECHNICAL SPECIFICATIONS

Fiber counts (G.657A2)	12F	24F
Cable diameter (LSZH)	8,5 ± 0,5 mm	10 ± 0,5 mm
Cable weight	Cca 75.0 kg/km	Cca 95.0 kg/km
Min. bend radius (load)	5× cable diameter	5× cable diameter
Min. bend radius (no load)	10× cable diameter	10× cable diameter
Tensile strength	500N	500N
Crush resistance	1000 N/100 mm	1000 N/100 mm
Temperature - storage	-40 °C to +70 °C	-40 °C to +70 °C
Temperature - installation	0 °C to +75 °C	0 °C to +75 °C
Temperature - operation	-45 °C to +60 °C	-45 °C to +60 °C

### ORDER CODES

Order Code	Name
HT0001	Riser cable 12F
HT0002	Riser cable 24F
852W.00/000BF	Riser box – white

### RISER BOX

It is used for branching individual fibers from the riser cable into customer drop microducts 5/3.5 mm ending in the FTTH mini socket.

- ▶ Max. number of outgoing microducts 8 pcs
- ▶ Fixation of cable and microducts using electrician cable ties
- ▶ The size of the branch window in the riser box max 10 cm
- ▶ Riser box is designed for indoor use only
- ▶ Dimensions 180 × 41 × 20 mm

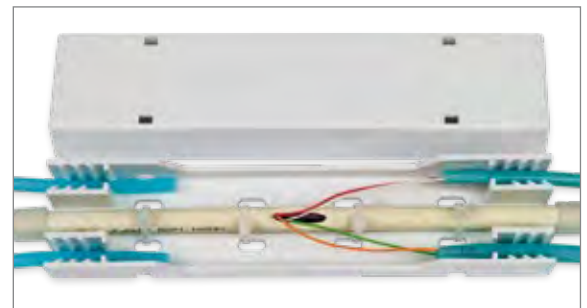

# RISER CABLE

## OUTDOOR OPTICAL CABLE

Riser outdoor cable is to be installed on the building facades with cable clips. This cable is being worked the same way like a standard riser cable inside the buildings. Black colour (UV stable)

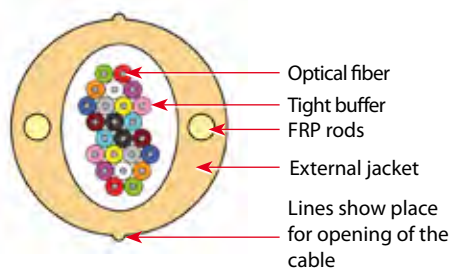

### TECHNICAL SPECIFICATIONS

Fiber counts (G.657A2)	24F
Cable diameter (LSZH)	10.5 ± 0.4 mm
Cable weight	91.3 kg/km
Min. bend radius (load)	5× cable diameter EN 60794-1-21-E11a
Min. bend radius (no load)	10× cable diameter EN 60794-1-21-E11b
Tensile strength	400N to EN 60794-1-21-E1
Crush resistance	80N to EN 60794-1-21-E3
Temperature – storage	-30 °C to +50 °C EN 60794-1-22-F1
Temperature – installation	-30 °C to +50 °C EN 60794-1-22-F1
Temperature – operation	-50 °C to +50 °C EN 60794-1-22-F1

### ORDER CODES

Order Code	Name
710342	Riser cable outdoor 24F
85BX.00/0100F	ORM 3 FA 12S
85BX.05/0000F	ORM 3 FA Extension set 12S

### ORM 3 FA

ORM 3 FA is an outdoor box designed for facades. The in-line solution with divisible grommets allows riser cable pass-through installation any time.

- ▶ Maximum capacity up to 36 splices
- ▶ Express port 2× 7–9 mm and 9× 2–5 mm
- ▶ Coverage degree IP54 to EN 60529
- ▶ Impact protection degree IK10 to EN 50102



NEW

GPON READY

MTeH MINI is a simple optical distribution box for the installation inside the buildings. Suitable as a floor box in larger buildings or as the main distribution box in buildings with no more than 8 flats. Vertical riser cable can be installed inside the box. Suitable for Gpon networks with pre-installed splitter. Box has separated section with hinged cover for individual access to adapters.

- ▶ Possibility to use for splicing or patching
- ▶ Capacity up to 10 SC simplex or SC duplex in a separate section
- ▶ Holder for 2 splices in the bottom of the box
- ▶ Possibility to place a TS 12 holder for 12 splices (max. 14 splices)
- ▶ Premoulded holes in the bottom for routing the cable through the wall
- ▶ Separate section for connecting customers
- ▶ Inputs for drop cables with the diameter up to 5mm from all sides
- ▶ Possibility to install vertical mid-span cable
- ▶ Possibility to use PLC splitters 1:8 or 2× 1:4 (small format)
- ▶ Screw lock
- ▶ Suitable solution for GPON networks
- ▶ For fiber G.657

## USE

- ▶ MTeH MINI is a compact size distribution box for the inner premises on the wall or for placing in the technical channels in multi-storey buildings. Connecting customers by less experience technician with limited access to inner splicing section.
- ▶ The user entries are on sides of the box and are designed to accommodate ducts or cables with max. of 5 mm diameter. An additional fixation by means of cable ties. Left entry points of the box are suitable for riser cable going through and standard cables.
- ▶ The box contains the holder for two heat-shrinks, suitable for splicing the splitter input. Extra splice holder for 12 splices can be additional placed into dedicated area.
- ▶ Premoulded breakouts at bottom of the box can be used for duct which is going through the wall.
- ▶ The box depth of 40 mm makes it suitable for internal vertical distribution in laths size 40×40 mm.
- ▶ The box contains plugs for the user outputs which can be broken off by segments as needed.

## TECHNICAL SPECIFICATIONS

Inputs Main cable	2× 1–14 mm
Outputs User cables	16× 1–5 mm
Coverage degree	IP 20 to EN 60529
Impact protection degree	IK 08 to EN 50102
Self-extinguishing degree	V0 according UL 94
Material	PC/ABS
Color	White RAL 9003
Dimensions (H×W×D)	150 × 140 × 40 mm
Weight	0.2 kg

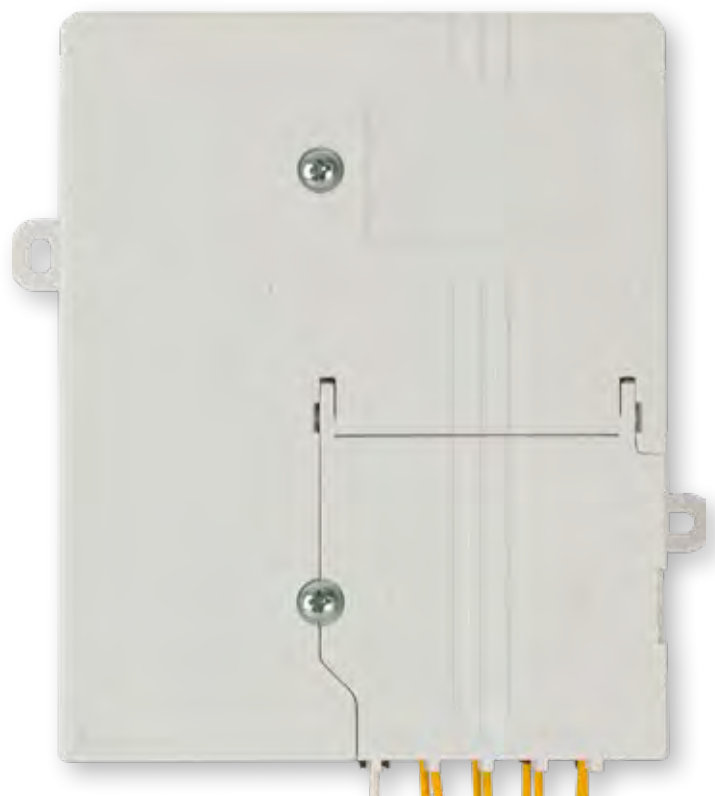

# MTeH MINI | INDOOR DISTRIBUTION BOX

**NEW** **GPON READY**

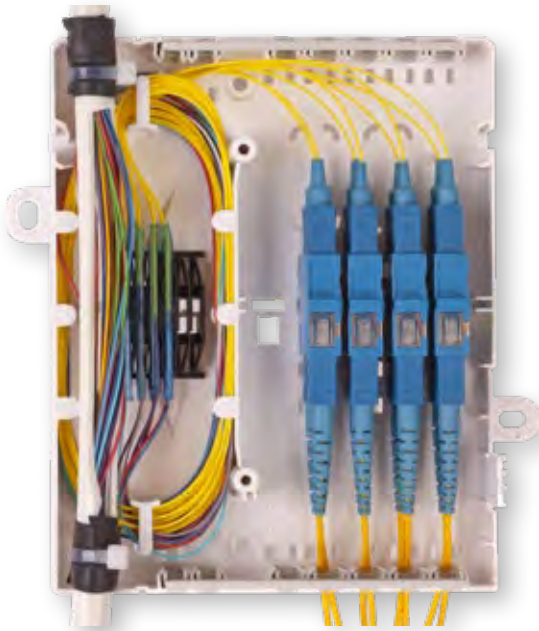

Solution with the riser cable (8 fibers terminated)

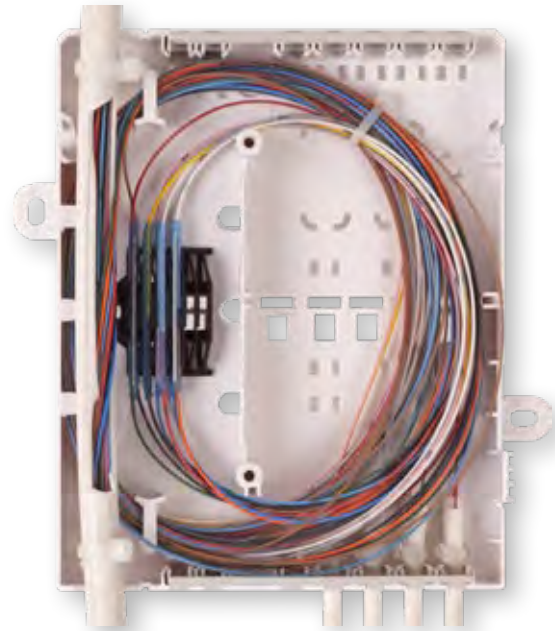

Solution with riser cable (splicing only)

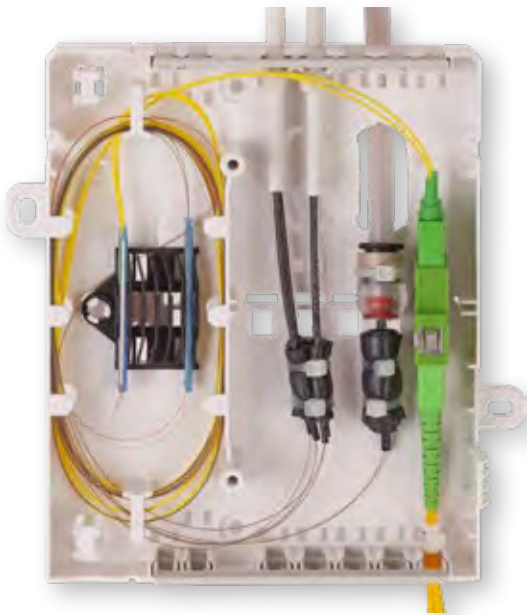

Combination of entry through the wall and connection the customers



Splice less solution with PLC splitter 1:8  
(splitter input goes into left adapter)

## ORDER CODES

Order codes	Name
85GR.00/0000F	MTeH MINI

For other variants, please, contact our sales department

# MTeH EASY | INDOOR DISTRIBUTION BOX

GPON READY

MTeH EASY is designed as a simple distribution box for indoor installation. Is destined especially for FTTH networks. MTeH EASY can be used for storage of pre-connectorized cable or blown cable which can be spliced after request of the customer. It could be used as distribution point in small building facility, or as floor box.

- ▶ Easy installation
- ▶ Wide portfolio of accessories
- ▶ Flat base with mounting holes
- ▶ Space for cable reserve before connecting customer
- ▶ Possibility to use the box for splicing or patching
- ▶ Two positions for adaptor plate
- ▶ Capacity up to 6× SC duplex, or 6× LC quad
- ▶ Graduated rubber bushing for cable Ø 3–10 mm (on each side)
- ▶ Breakable outputs on back side (connection through the wall directly to customer)
- ▶ Possibility to use loop-through cable
- ▶ Splice tray KM 4 (max. capacity 24 splices)
- ▶ 4× splice tray KM 3 (max. capacity 48 splices for fibres G.657)
- ▶ Possibility to place PLC splitter



Slack box



## TECHNICAL SPECIFICATIONS

Bushings	Graduated bushing (3–10 mm)
Coverage degree	IP20 to EN 60529
Self-extinguishing degree	V2 to UL 94
Impact protection degree	IK 5 to EN 50102
Material	ABS – Halogen free, flame retardant (V2)
Colour	White, RAL 9003
Dimensions	205 × 157 × 60 mm
Weight	0.350 kg

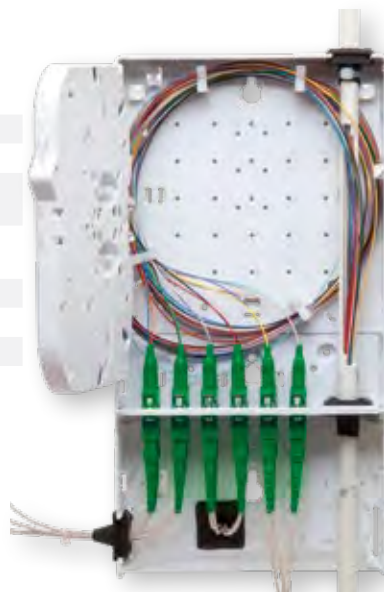

MTeH EASY 24S/12C with adapter cover

YouTube



MTeH EASY 48S



# MTeH EASY | INDOOR DISTRIBUTION BOX

GPON READY

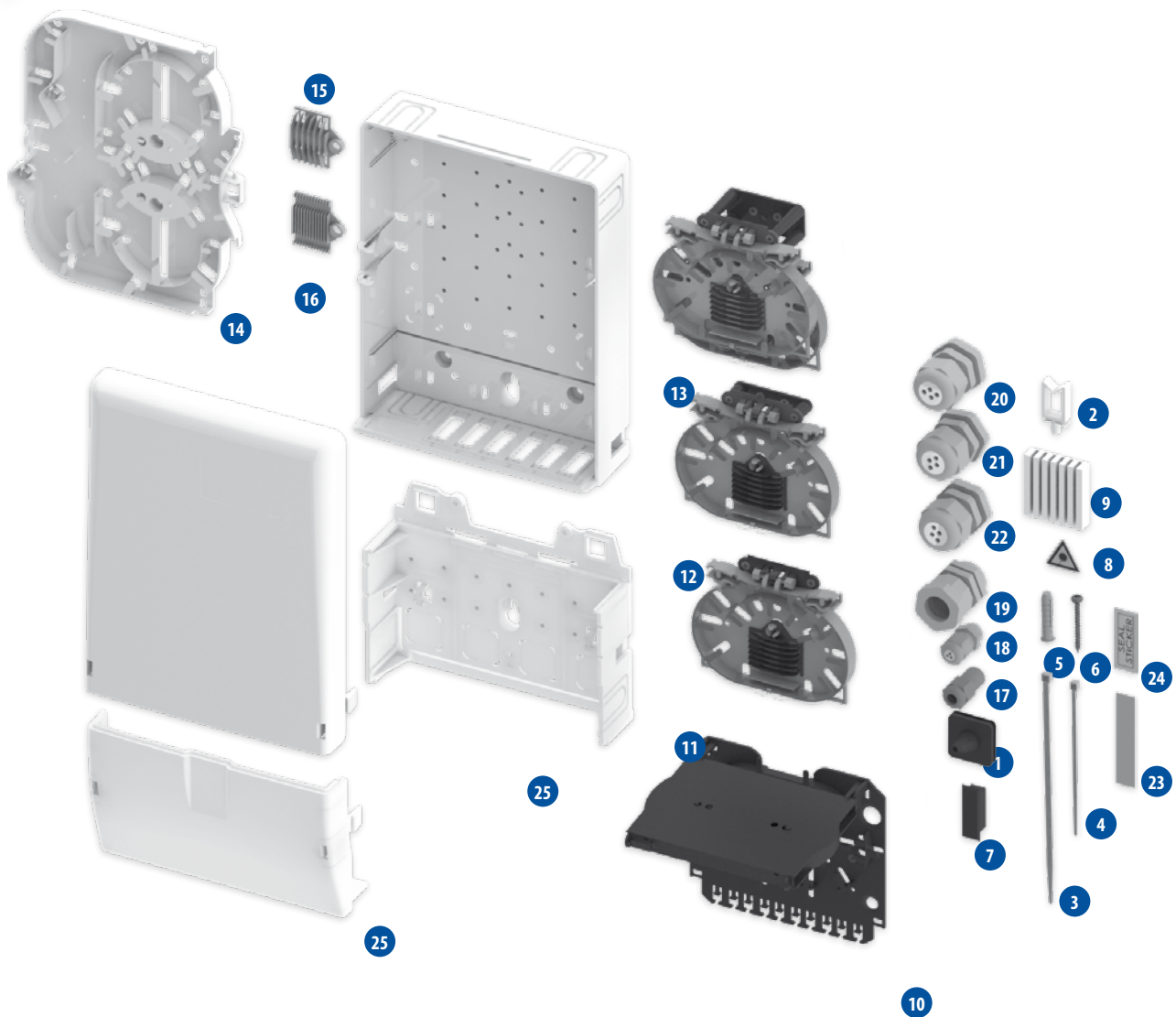

## OPTIONAL ACCESSORIES

Order Code	Name	Position
85SP.02/1000	Graduated bushing (3–10 mm)	1
325800	Cable holder	2
018400	Cable tie PVC 3.6 × 150	3
490594	Cable tie PVC 2.5 × 100	4
490903	Dowel 6 mm	5
490904	Screw 4 × 30	6
CN0061	Plug duplex	7
276900	Laser sticker	8
8541.35/BALOF	Rubber splice holder CTS12	9
85BV.31/0000F	KM 2 + management	10
85BV.29/0010F	Splice tray KM 3 with hinge	11
85BV.29/001RF	Splice tray KM 3 with hinge and reduction	12
85BV.29/002RF	Splice tray KM 3 with hinge and reduction	13

Order Code	Name	Position
85BV.32/0000F	Splice tray KM 4 with lid	14
85M9.16/0000	Splice holder TS 12	15
85M9.17/0000	Splice holder K 12	16
85BV.25/000TF	PG7 (2.5–6.5 mm)	17
85BV.25/0MVLF	PG 7, (3 × 1.6–2.6mm)	18
301100	PG 16 (8–16 mm)	19
8580.67/000MF	PG 16 HI/SEZ (2 × 3 mm)	20
8580.68/000MF	PG 16 HI/SEZ (4 × 3 mm)	21
8580.66/000MF	PG 16 HI/SEZ (4 × 5 mm)	22
492779	Double-sided tape 60 × 12 mm	23
85AX.06/0000	Seal sticker 40 × 15 mm	24
85AX.15/0000F	Base and adapters cover	25

For other variants, please, contact our sales department.

## ORDER CODES

Order Code	Name
85AX.00/0000F	MTeH EASY – Slack box
85AX.00/0002F	MTeH EASY 24S/12C
85AX.00/0003F	MTeH EASY 48S

For other variants, please, contact our sales department.

GPON READY

MTeH UNI is designed to be very versatile optical distribution box, which can realize a wide range of configurations and interconnect the fibers in many ways. Wall box is suitable primarily as a distribution point in FTTH networks. Box includes two types of connector panel and two large splice trays KM 4.

- ▶ Easy installation
- ▶ Removable cover
- ▶ Cable reserves brackets
- ▶ Cable management
- ▶ Ability to splice in the bottom of the box
- ▶ Optional splicing or splitter boxes
- ▶ Possibility to use the box for splicing or patching
- ▶ Removable connector panel for 12× SC simplex, 12× SC duplex, 12× LCD or 12× LCQ
- ▶ Connector plate protected with a cover
- ▶ Gradual bushing  $\varnothing$  3–14 mm
- ▶ Input for 12 microducts up to  $\varnothing$  7 mm
- ▶ Preparation for the side entrance of Wall rails
- ▶ Optional wall through installation
- ▶ Mid-span access
- ▶ 2× splice tray KM 4 – total capacity 48 splices
- ▶ Maximum capacity 72 splices using splice section in the bottom of the box
- ▶ Duplex adapter point to connect PLC splitter
- ▶ Coverage degree IP 20
- ▶ For outdoor version see page 030 (URM LH 48C UNI)

YouTube



EN 1



EN 2



## TECHNICAL SPECIFICATIONS

Bushings	Graduated bushing (3–14 mm)
Coverage degree	IP20 to ČSN EN 60529
Self-extinguishing degree	V2 to UL 94
Impact protection degree	IK 7 to EN 50102
Material	ABS – Halogen free, flame retardant (V2)
Colour	White, RAL 9003
Dimensions	340 × 235 × 60 mm
Weight	0.8 kg

**GPON READY**

Examples of installation

MTeH UNI 12× SC



Box for splicing



MTeH UNI 48× LC

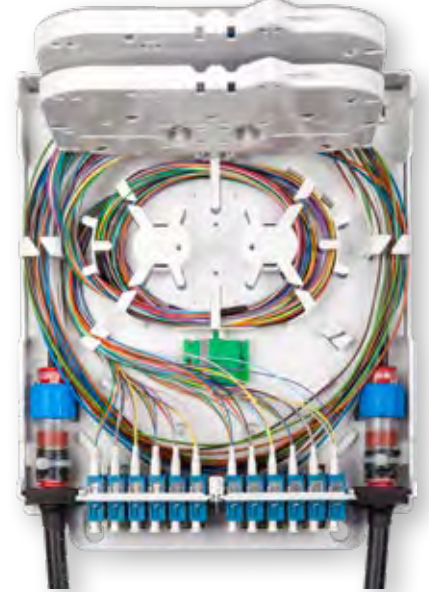

Example of PLC splitter installation  
Příklad instalace PLC splitteru

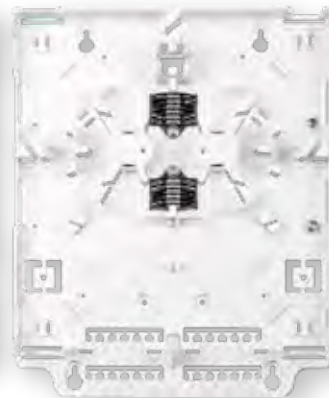

Example of extra splice tray holder  
Příklad s extra držáky svárů

## OPTIONAL ACCESSORIES

Order Code	Name
85M9.16/0000	Splice holder TS 12
85M9.17/0000	Splice holder K 12
85SP.02/0000	Graduated bushing (3–14 mm)

For other variants, please, contact our sales department.

## ORDER CODES

Order Code	Name
85AV.00/0001F	MTeH UNI

For other variants, please, contact our sales department.

The ORM 3 line of distribution boxes is designed for the placement of optical connectors and splices both indoors and outdoors. The distribution box may be complemented by a simple bracket, which enables it to be post-mounted. To increase the capacity the extension frame and second tray for splices can be used.

- ▶ Easy assembly
- ▶ Wall-mounted or post-mounted
- ▶ Use for fibers G.657
- ▶ Fixation of input/output cables
- ▶ Lid is fixed with screws



## TECHNICAL SPECIFICATIONS

Coverage degree	IP 54 to EN 60529 / IEC 529
Self-extinguishing degree	V0 to UL 94
Impact protection degree	IK10 to EN 50102
Solar radiation (UV)	EN 60068-2-5
Colour	Light grey RAL 7035
Material	PC/ABS
Material bushings	PA6, TPV / ENSOFT
Dimensions	
– ORM 3 L/2(4)	136 × 136 × 46 mm
– ORM 3 SL 12S	136 × 136 × 46 mm
– ORM 3 SH 24S	136 × 136 × 64 mm
– ORM 3 FA	136 × 136 × 46 / 64 / 84 mm
Weight	0.4 kg / 0.6 kg

## ORDER CODES ACCESSORIES

Order Code	Name	
85K3.11/BAL0F	Post Brackets	1
85BV.16/0000F	Mnx frame-set	2

## ORM 3 FA

GPON READY 5G READY

ORM 3 FA is designed for façades. The in-line solution permits the passage of an outdoor riser cable that runs along the façade. The necessary fibers are pulled out of the cable, as is the case with conventional riser cables inside the building. For drop cables there is a separate bushing for up to 11 cable entries. The box contains fiber management and a splice tray for 12 splices. If necessary, the box can be expanded by an extension frame and additional second trays to increase the splicing capacity to 36.

- ▶ Capacity of 12/24/36 optical splices
- ▶ Possibility to place PLC splitter
- ▶ In-line solution for outdoor riser cable 2× Dividable rubber bushing (10–13 mm)
- ▶ Express port (2× 7–9 mm) and (9× 2–5 mm)
- ▶ Possible overcoated

## ORDER CODES

Order Code	Name
85BX.00/0100F	ORM 3 FA 12S
85BX.05/0000F	ORM 3 FA EXTENSION SET 12S

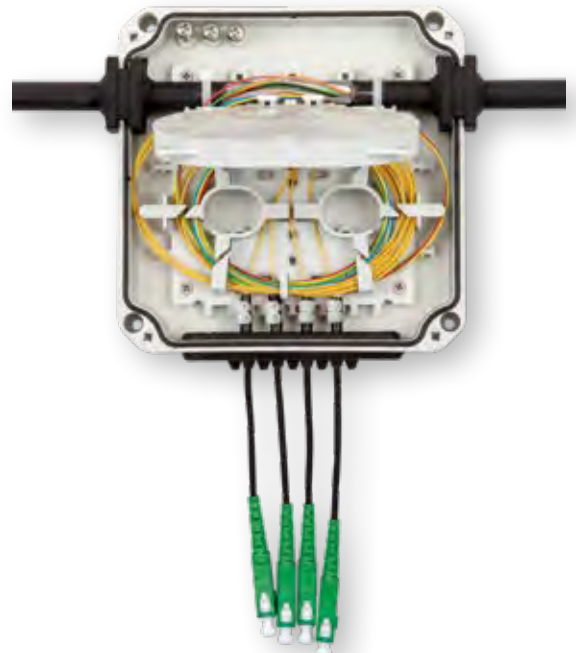

YouTube



# ORM 3 L/2

# ORM 3 L/4

▶ GPON READY ▶ 5G READY

- ▶ Capacity of 2 / 4 optical connectors
- ▶ Connector holder SC simplex/duplex
- ▶ Bushings 1× PG7 (3–6.5 mm), 2× Dividable rubber bushing (2× 1–3 mm)
- ▶ Placement of optical fiber reserve, length 1 m



ORM 3 L/2

ORM 3 L/4

## ▶ ORDER CODES

Order Code	Name
85K3.40/0000F	ORM 3L/2
85K3.50/0000F	ORM 3L/4

# ORM 3 SL 12S

# ORM 3 SH 24S

▶ GPON READY ▶ 5G READY

- ▶ Capacity of 12/24 optical splices
- ▶ Integrated fibre management
- ▶ 1×/2× KM 3 splice tray for the placement of optical splices
- ▶ Bushings Express port (2× 7–9 mm) and (9× 2–5 mm)
- ▶ Placement of optical fiber reserve, length 3 m
- ▶ Possibility of PLC splitter placement
- ▶ 1 × universal rubber bushing (for express port and individual inputs/outputs)
- ▶ 2×  $\varnothing$  to 10 mm and 8×  $\varnothing$  to 5 mm



ORM 3 SL 12S

ORM 3 SH 24S

## ▶ ORDER CODES

Order Code	Name
85K3.60/0000F	ORM 3 SL 12S
85K3.70/0000F	ORM 3 SH 24S

GPON READY

5G READY

The ORM 4(8) optical distribution box is designed for the placement of 4 optical (duplex) connectors both indoors and outdoors. The distribution box may be complemented by a simple bracket, which enables it to be post-mounted.

- ▶ Capacity of 4/8 optical connectors
- ▶ Connector holder SC simplex, ST, FC, E2000, LC/ LC duplex, E2000 compact, SC duplex
- ▶ Placement of optical fiber reserve, length 1 m
- ▶ PG bushings
- ▶ Lockable lid
- ▶ Easy assembly
- ▶ Wall-mounted, post-mounted
- ▶ Coverage degree IP 54

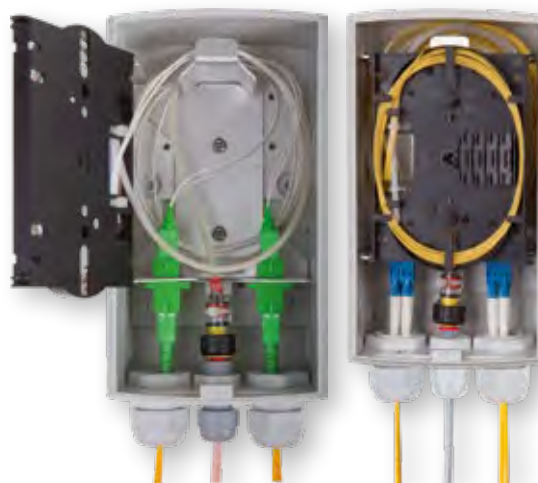

ORM 4

ORM 8



POST BRACKET

### TECHNICAL SPECIFICATIONS

Bushings	2× PG16 (2/4×3 mm); 1× PG9 (4–8 mm)
Coverage degree	IP 54 to EN 60529
Self-extinguishing degree	V0 to UL 94
Impact protection degree	IK 10 to EN 50102
Solar radiation (UV)	EN 60068-2-5
Change of temperature	-40 °C/+70 °C according to EN 60068-2-14
Colour	Light grey RAL 7035
Material – distribution box	PC/ABS
Material – bushings	PA6
Material – metallic parts	Aluminium
Material – pillar	Stainless steel
Dimensions	185 × 103 × 73 mm
Weight	0.6 kg

### RECOMMENDED ACCESSORIES

- Post Brackets page 066
- Base plate with a cover
- Other accessories on the pages 067–075

### ORDER CODES

Order Code	Name
8520.00/0000NBQ0125P--	ORM 4 holder 4× E2000, SC
8520.20/0000NBQ0125P--	ORM 8 holder 4× LC duplex
8520.20/0000NBQ1425P--	ORM 8 holder 4× SC duplex
8520.20/0000NBQ1525P--	ORM 8 holder 4× E2000 compact
8545.00/0000F	Base plate and cover
8170.71/0000F	Post bracket

For other variants, please, contact our sales department.  
Pre-installed versions available upon request.

GPON READY

5G READY

Lockable optical distribution box ORM 5 is designed for indoor/outdoor wall installation at the customers' premises or as a separate pillar. The box is suitable mainly in FTTH network to terminate optical fibres on the internal/outdoor walls of the buildings mainly in suburban areas with lower household density (family houses, low household count residential buildings or offices). Additionally, the box can play the role of the floor distribution box in multidwelling units.

- ▶ Simple wall installation
- ▶ Easy access due to hinged removable cover
- ▶ Lockable cover (optional)
- ▶ Coverage degree IP 54
- ▶ Gradual cable gland located in the lower wall for the cables with the outside diameters between 3 and 14 mm
- ▶ Gradual cable gland located in the bottom for the cables with the outside diameters between 3 and 10 mm (for the wall through installations)
- ▶ Pre-fabricated holes in the bottom for the wall through patchcord installation
- ▶ 4 prefabricated holes for dividable bushing capable to seal up to 2 patchcords or heavy duty subscriber cables
- ▶ Can accommodate up to 4× SC or 2× E2000, eventually 8× LC connectors and pigtails
- ▶ Splice cassette supporting up to 12 heat-shrink or crimp fusion splice protective sleeves or mechanical splices (up to 4 pieces).
- ▶ Ready to accommodate Gas block for the microtubes with various outside diameters (5, 7, 10, 12 and 14 mm) at the input of the box



## TECHNICAL SPECIFICATIONS

Bushings – right part	1× Gradual bushing (3–14 mm) for incoming cable
Bushings – left part	4× Dividable rubber bushing (2× 1–3 mm) or 4× Gradual bushing (3–14 mm)
Bushings – bottom (wall through)	Gradual bushing (3–10 mm) for incoming cable
Coverage degree	IP 54 to EN 60529
Impact protection degree	IK 10 to EN 50102
Solar radiation (UV)	EN 60068-2-5
Change of temperature	-40 °C/+70 °C according to EN 60068-2-14
Color	Light grey RAL 7035
Material	PC+ABS
Material – pillar	Stainless steel
Dimensions	235 × 156 × 45 mm
Weight	0.5 kg

## ORDER CODES

Order Code	Name
85SP.00/0000F	ORM 5
85BV.01/0000F	Lock for ORM 5
85E0.97/00R5F	Post Bracket for ORM 5

For other variants, please, contact our sales department.  
Pre-installed versions available upon request.

YouTube



POST BRACKET FOR ORM 5

# COYOTE® STP – JR | OPTICAL SPLICE CLOSURE











NEW GPON READY 5G READY

The COYOTE® STP-JR (Service Termination Point) is a small closure which provides an alternative to traditional network interface devices, while offering much greater application flexibility. The robust latch system, paired with an integrated overmolded cover, allows for quick re-entry and creates a secure seal over a wide range of cable profiles. The closure could be installed indoors or outdoors on a pedestal, wall or pole.

- ▶ Maximum capacity 4 drop cables
- ▶ Maximum capacity 12 splices
- ▶ Maximum capacity of adapter is 2× SC
- ▶ Possibility of PLC splitter placement (max. length 40 mm)
- ▶ Applications below grade, direct buried, pole/wall mount, and pedestal mount
- ▶ Supports up to 2 single or multi-hole bushings covering a cable  $\varnothing$  2.4 mm–14 mm
- ▶ Re-enterable and reusable
- ▶ Designed to the TELCORDIA GR-771-CORE standard
- ▶ Constructed with UV stabilized, flame retardant material



## STP-JR BUSHINGS

	Solid / Plug
	4.3–5.6 mm Round Cable
	5.6–6.9 mm Round Cable
	6.9–5.1 mm Round Cable
	8.1–9.4 mm Round Cable
	9.4–10.7 mm Round Cable
	10.7–11.9 mm Round Cable
	11.9–14.0 mm Round Cable
	4× 2.4–3.2 mm Round Drop Cable
	4× 3.8 mm Round Drop Cable

## TECHNICAL SPECIFICATIONS

Bushings	2× Multi-Hole
Coverage degree	IP 68
Self-extinguishing degree	V0 to UL 94 – 5VA Rated
Solar radiation (UV)	EN 60068-2-5
Colour	Grey
Material	Polycarbonate
Dimensions	200 × 125 × 49 mm



NEW

GPON READY







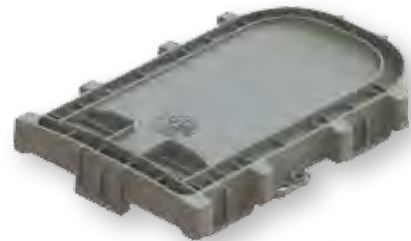



5G READY

The COYOTE® STP-MD is a compact splice closure which supports straight splice, splice to drop/branch and internal connectivity applications. Ideal for applications in the FTTX distribution network for splice applications 24 fibers or less and connectivity solutions. Ideal product for blown fiber cable and microtube cable applications. Also supports use of traditional buffer tube cables.

- ▶ Maximum capacity 8 drop cables
- ▶ Maximum capacity 24 splices
- ▶ Maximum capacity of adapter is 4× SC
- ▶ Possibility of PLC splitter placement (max. length 40 mm)
- ▶ If splitter installed, splice count drops to 21 single fusion splices
- ▶ Applications below grade, direct buried, pole/wall mount, and pedestal mount
- ▶ Supports up to 4 single or multi-hole bushings covering a cable  $\varnothing$  2.4–14 mm
- ▶ Re-enterable and reusable
- ▶ Designed to the TELCORDIA GR-771-CORE standard
- ▶ Constructed with UV stabilized, flame retardant material



### STP-JR BUSHINGS

	Solid / Plug
	4.3–5.6 mm Round Cable
	5.6–6.9 mm Round Cable
	6.9–5.1 mm Round Cable
	8.1–9.4 mm Round Cable
	9.4–10.7 mm Round Cable
	10.7–11.9 mm Round Cable
	11.9–14.0 mm Round Cable
	4× 2.4–3.2 mm Round Drop Cable
	4× 3.8 mm Round Drop Cable

### TECHNICAL SPECIFICATIONS

Bushings	4× single or multi-hole for cable with $\varnothing$ 2.4–14 mm
Coverage degree	IP 68
Self-extinguishing degree	V0 to UL 94 – 5VA Rated
Solar radiation (UV)	EN 60068-2-5
Colour	Grey
Material	Polycarbonate
Dimensions	200 × 125 × 70 mm

The URM line optical distribution boxes are suitable both for internal and external application and could be wall or pole-mounted. The URM line consists of four box sizes (SL, SH, LL, LH). The boxes can be configured with a range of fiber organizer systems to support splice, distributed splitter and drop applications using traditional cable, blown fiber cable, pushable drop cable technology or micro-tube cable.

- ▶ Splicing capacity up to 144 heat shrink splices
- ▶ Cross-connect capacity up to 48 optical connectors
- ▶ Hinged lockable door
- ▶ 4 different sizes SL, SH, LL and LH
- ▶ Robust plastic design (IK10)
- ▶ Water and dust protected (IP54)

#### TECHNICAL SPECIFICATIONS

Coverage degree	IP 54 to EN 60529
Self-extinguishing degree	V0 to UL 94
Impact protection degree	IK 10 to EN 50102
Solar radiation (UV)	EN 60068-2-5
Change of temperature	-40 °C/+70 °C according to EN 60068-2-14
Colour	Light grey RAL 7035
Material	PC/ABS
<b>Dimensions</b>	
– URM SL	216 × 154 × 68 mm
– URM SH	216 × 154 × 90 mm
– URM LL	350 × 250 × 68 mm
– URM LH	350 × 250 × 90 mm

#### ORDER CODES

Order Code	Name
85E0.97/0000F	Post Brackets



POST BRACKETS

## URM SL 12C / URM SL 12C M

5G READY

- ▶ Maximum capacity is 12× LC (plastic holder) or possibility to install an aluminium adapter holder for 12× SC simplex
- ▶ Integrated fibre management + 1× KM 3 splice tray for the placement of optical splices
- ▶ Bushings 1× PG9 (5–8.5 mm), 6× Dividable rubber bushing (2× 1–3 mm)
- ▶ Use for fibers G.657

#### ORDER CODES

Order Code	Name
85RP.00/0000F	URM SL 12C
85RP.20/0000F	URM SL 12C M



URM SL 12C

URM SL 12C M

## URM SL 24S

GPON READY 5G READY

- ▶ Maximum capacity is 24 optical splices
- ▶ Integrated fibre management + 2x KM 3 splice tray for the placement of optical splices
- ▶ Bushings 4× PG9 (5–8.5 mm)
- ▶ Possibility of PLC splitter placement
- ▶ Fixation of input/output cables
- ▶ Use for fibers G.657

#### ORDER CODES

Order Code	Name
85RN.00/0000F	URM SL 24S

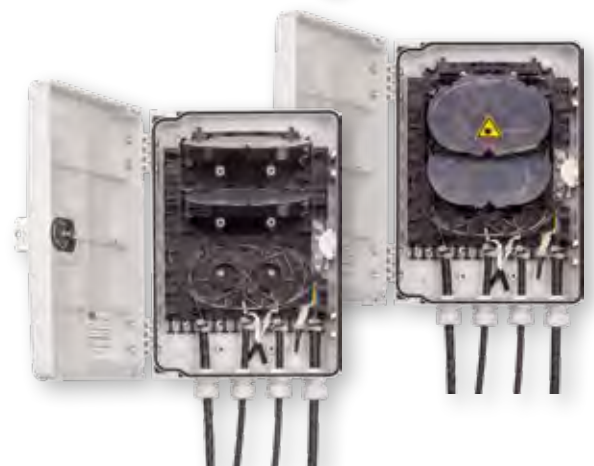

# URM SH 24C / URM SH 24C M

5G READY

- ▶ Maximum capacity of adapters is 12× SC/DX /6× LC quad
- ▶ Integrated fibre management + 2× KM 3 splice tray for the placement of optical splices
- ▶ Bushings 1× PG13.5 (8–12 mm); 12× Dividable rubber bushing (2× 1–3 mm)
- ▶ Possibility of PLC splitter placement
- ▶ Use for fibers G.657

## ORDER CODES

Order Code	Name
85RP.10/0000F	URM SH 24C
85RP.45/0000F	URM SH 24C M



URM SH 24C  
URM SH 24C M

# URM SH 48S

GPON READY 5G READY

- ▶ Maximum capacity is 48 optical splices
- ▶ Integrated fibre management + 4x KM 3 splice tray for the placement of optical splices
- ▶ Bushings 4× PG9 (5–8.5 mm)
- ▶ Possibility of PLC splitter placement
- ▶ Fixation of input/output cables
- ▶ Use for fibers G.657

## ORDER CODES

Order Code	Name
85RN.10/0000F	URM SH 48S



# URM LL 24C M

GPON READY 5G READY

- ▶ Maximum capacity of adapters is 12× LC duplex, 12× SC duplex or 24 SC simplex
- ▶ 2× KM 1 splice tray for the placement of optical splices
- ▶ Bushings 2× PG13.5 (8–12 mm); 12× Dividable rubber bushing (2× 1–3 mm)
- ▶ Possibility of PLC splitter placement
- ▶ Use for fibers G.652d and G.657

## ORDER CODES

Order Code	Name
85RR.05/0000F	URM LL 24C M



# URM LL 48S

GPON READY 5G READY

- ▶ Maximum capacity is 48 optical splices
- ▶ Integrated fibre management + 4× KM 3 splice tray for the placement of optical splices
- ▶ Bushings 4× PG13.5 (8–12 mm)
- ▶ Possibility of PLC splitter placement
- ▶ Fixation of input/output cables
- ▶ 4× cable eye for placement of cable reserves
- ▶ Holders of tension element
- ▶ Use for fibers G.657

## ORDER CODES

Order Code	Name
85RQ.00/0000F	URM LL 48S



# URM LH 48C M

5G READY

- ▶ Maximum capacity of adapters is 48x SC simplex
- ▶ 2x EC2 splice tray for the placement of optical splices
- ▶ Bushings 2x PG16 (8–16 mm); 2x PG29 (24x3 mm)
- ▶ Possibility of PLC splitter placement
- ▶ Use for fibers G.652d and G.657

## ORDER CODES

Order Code	Name
852L.30/0000F	URM LH 48C M



# URM LH 48C UNI

GPON READY 5G READY

- ▶ Maximum capacity of adapters is 12x SC simplex or 12x SC duplex or 12x LC duplex or 12x LC QUAD
- ▶ 2x KM 4 splice tray for the placement of optical splices
- ▶ Bushings 2x PG13.5 (8–12 mm); 24x Dividable rubber bushing (2x 1–3 mm)
- ▶ Possibility of PLC splitter placement
- ▶ Use for fibers G.652d and G.657

## ORDER CODES

Order Code	Name
85FR.55/0000F	URM LH 48C UNI



# URM LH 16 SDF

GPON READY 5G READY

The optical distribution box URM LH 16 SDF is designed for splicing, connectors connection and placing the splitter 1:8, 1:16. The box is ideal for FTTx applications.

- ▶ Capacity of 16 optical connectors
- ▶ Connector holder LC duplex, SC duplex
- ▶ Extra 2 optional adapter positions for connecting the input optical cable with splitter, or for measurement over one fiber outgoing from the splitter
- ▶ 1–2 KM 1 optical splice trays for splices placing
- ▶ 2x space for routing of incoming and outgoing fibers
- ▶ Express port
- ▶ Use for fibers G.652d and G.657

## ORDER CODES

Order Code	Name
85DE.00/0000F	URM LH 16 SDF



# URM LH 96S

GPON READY 5G READY

- ▶ Maximum capacity is 96 optical splices
- ▶ Integrated fibre management + 8× KM 3 splice tray for the placement of optical splices
- ▶ Bushings 4× PG13.5 (8–12 mm)
- ▶ Possibility of PLC splitter placement
- ▶ Fixation of input/output cables
- ▶ 4× cable eye for placement of cable reserves
- ▶ Holders of tension element
- ▶ Use for fibers G.657

## ORDER CODES

Order Code	Name
85RQ.10/0000F	URM LH 96S



# URM LH 144S

GPON READY 5G READY

- ▶ Maximum capacity is 144 optical splices
- ▶ 6× EC2 splice tray for the placement of optical splices
- ▶ Bushings 4× PG16 (8–16 mm)
- ▶ Possibility of PLC splitter placement
- ▶ Fixation of input/output cables
- ▶ 4× cable eye for placement of cable reserves
- ▶ Holders of tension element
- ▶ Use for fibers G.652d and G.657

## ORDER CODES

Order Code	Name
85RQ.20/0000F	URM LH 144S



# ORM 16 SDF ORM 16 SDF SIS

OPTICAL DISTRIBUTION BOX/PILLAR

GPON READY

5G READY

The optical distribution box ORM 16 SDF / 16 SDF SIS is designed for splicing, connectors connection and placing the splitter 1:8, 1:16. The box is ideal for FTTx applications.

- ▶ Capacity of 16 optical connectors
- ▶ Connector holder SC simplex, SC duplex
- ▶ Possibility of pillar version or on the pole
- ▶ Extra 2 optional adapter positions for connecting the input optical cable with splitter, or for measurement over one fiber outgoing from the splitter.
- ▶ 1–2 KM 1 optical splice trays for splices placing
- ▶ 2× space for routing of incoming and outgoing fibers
- ▶ Optical connector holder 8× SC/DX + 1× SC/ SX



POST BRACKETS



## TECHNICAL SPECIFICATIONS

Bushings	2× PG13.5 (8–12 mm); 1× PG29 (24×3 mm)
Coverage degree	IP 54 to EN 60529
Self-extinguishing degree	V0 to UL 94
Impact protection degree	IK 10 to EN 50102
Solar radiation (UV)	EN 60068-2-5
Change of temperature	-40 °C/+70 °C according to EN 60068-2-14
Colour	Light grey RAL 7035
Material – distribution box	PVC, PC/ABS
Material – bushings	PA6, TPE-S
Material – metallic parts	Aluminium
Dimensions	319 × 205 × 118 / 1747 × 290 × 209 mm
Weight	2/11 kg

## RECOMMENDED ACCESSORIES

- Splice trays
- Splice holders
- Post Brackets

Other accessories on the pages 066–075

## ORDER CODES

Order Code	Name
8588.70/0000F	ORM 16 SDF with optical connector holder 8×SC/DX + 1×SC/SX
8588.80/SI00F	ORM 16 SDF SIS with optical connector holder 8×SC/DX + 1×SC/SX
8286.10/2000F	Post Brackets

For other variants, please, contact our sales department.  
Pre-installed versions available upon request.

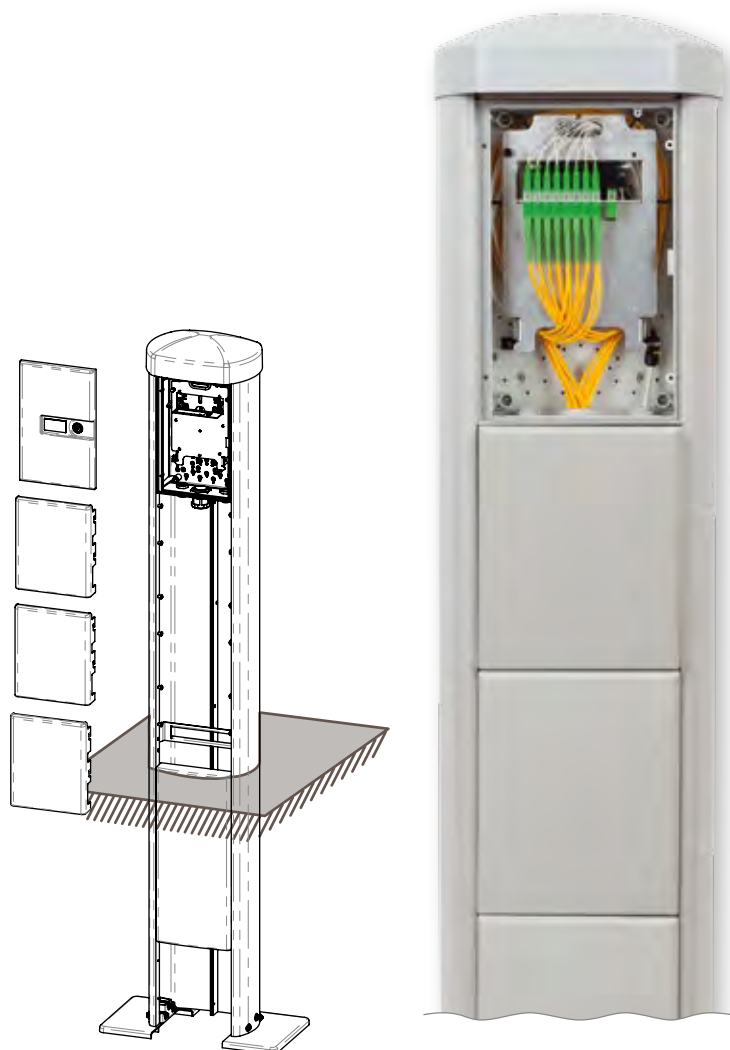

# SNM 48 SIS, SNM 72 VS SIS SNM 144 VS SIS | OPTICAL PILLAR CLOSURE

GPON READY

5G READY

Optical overground closure SNM 48 SIS / 72 VS SIS / 144 VS SIS is designed for the termination of 48/72/144 optical splices outdoors. The distribution box is to be installed in an open space in trench. The plastic corpus of pillar is staffed by one SNM 48/72 distributor or by two SNM 72 distributors.

- ▶ Maximum capacity is 48/72/144 optical splices
- ▶ Plastic corpus
- ▶ Installation – separate pillar
- ▶ Possibility of shortened pillar version
- ▶ Placement of optical fiber reserve, length 2 m
- ▶ Cable holders
- ▶ Management rings
- ▶ PG Bushings



SNM 48 SIS



SNM 72 VS SIS

## TECHNICAL SPECIFICATIONS

Bushings	4× PG 13.5 (8–12 mm)
Coverage degree	IP 54 to EN 60529
Self-extinguishing degree	V0 to UL 94
Impact protection degree	IK 10 to EN 50102
Solar radiation (UV)	EN 60068-2-5
Colour	Light grey RAL 7035
Material – distribution box	PVC, PC/ABS
Material – bushings	PA6
Material – metallic parts	Painted steel/aluminium
Dimensions	1747 × 290 × 209 mm
Weight	11 kg

## RECOMMENDED ACCESSORIES

Splice trays	
Splice holders	
Lid	
Other accessories on the pages 067–075	

## ORDER CODES

Order Code	Name
85F0.10/0000F	SNM 48 SIS
85HC.20/0000F	SNM 72 VS SIS
85LG.10/0000F	SNM 144 VS SIS

For other variants, please, contact our sales department.

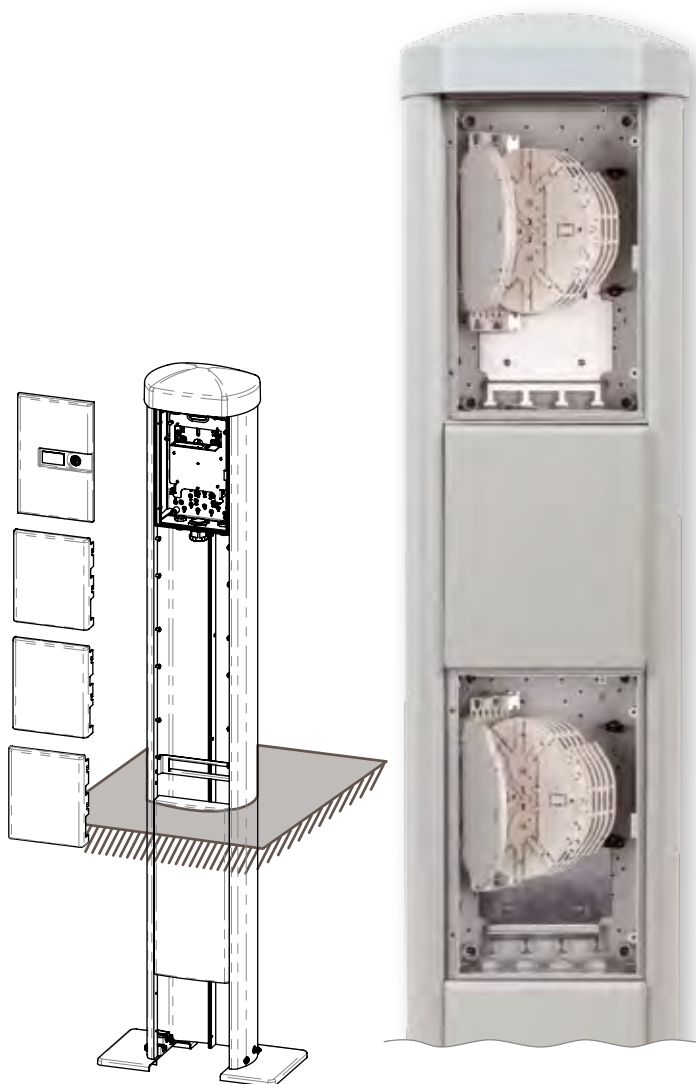

**NEW** **GPON READY** **5G READY** **FiberRoad**

Optical pillar closure MDP OZ 144/288/432S is designed for the placement of 144/288/432 optical splices outdoors. The pillar is to be installed in open space in trench. The cabinet is supplied without the splice trays. The solution is recommended for spliced GPON networks.

- ▶ Compact solution (footprint 264 × 245 mm)
- ▶ Modular pillar height based on the maximum capacity
- ▶ Three-point lock door
- ▶ Duct holder in the basement
- ▶ Cable rings for placing cable reserves
- ▶ Hingeable/detachable splicing plate
- ▶ FiberRoad system
- ▶ Possibility of adding trays as your network grows
- ▶ Possibility of placing PLC splitters in the management (outside the trays)
- ▶ Suitable for spliced GPON networks
- ▶ Tray KM 4 or KM 6 for 24 splices
- ▶ Optional ribbon splice holders
- ▶ Possibility of loop cable



KM 6



KM 4



FiberRoad system



MDP OZ 432S



MDP OZ 144S



MDP OZ 288S

### TECHNICAL SPECIFICATIONS

Entry	2× Express port (2× 3–11 mm) and (16×5 mm)
Coverage degree	IP54 to EN 60529
Impact protection degree	IK 10 to EN 50102
Material	Polyester + glass fibre
Color	RAL 7035
Dimensions (H × W × D)	1300/1500/1700 × 245 × 264 mm
Height above the ground	700/900/1100 mm
Height above the ground incl. cable base	950/1150/1350 mm
Weight	14/17/20 kg

### ORDER CODES

Order Code	Name
85GB.00/0000F	MDP OZ 144S
85GB.20/0000F	MDP OZ 288S
85GB.40/0000F	MDP OZ 432S
495630	Cable base (extension leg pillar)
85AV.04/0000	Tray KM 4
85AV.05/0000	Lid tray KM 4
495535	Tray KM 6
495536	Lid tray KM 6
85M9.16/0000	TS 12 splice holder (2 pcs needed for one KM 4)
495241	TS 12 splice holder (2 pcs needed for one KM 4)
495241	RIB 3 holder 3× ribbon or splitter 4× 4 mm (2 pcs needed for one KM 4)

For other configurations will you please contact our sales department.



# MDP OZ 24/48, MDP OZ 48/96, MDP OZ 72/144 | OPTICAL DISTRIBUTION PILLAR

NEW GPON READY 5G READY FibeRoad

Optical pillar MDP OZ 24/48, 48/96, 72/144 is designed for the placement of 24/48/72 SC connectors or 48/96/144 LC connectors outdoors. The pillar is to be installed in open space in trench. The cabinet is supplied without the splice trays. The solution is recommended for spliced GPON networks.

- ▶ Compact solution (footprint 264 × 245 mm)
- ▶ Modular pillar height based on the maximum capacity
- ▶ Three-point lock door
- ▶ Duct holder in the basement
- ▶ Cable rings for placing cable reserves
- ▶ Hingeable/detachable splicing/patching plate
- ▶ FibeRoad system
- ▶ Possibility of adding trays as your network grows
- ▶ Possibility of placing PLC splitters in the management (outside the trays)
- ▶ Possibility to combine trays KM 4, KM 5, KM 6
- ▶ Tray KM 5 for 12 SC or 24 LC connectors
- ▶ Optional ribbon splice holders
- ▶ Possibility of loop cable
- ▶ Max. 4 pcs PLC Splitters ABS



KM 5



FibeRoad system



## TECHNICAL SPECIFICATIONS

Entry	2× Express port (2× 3–11 mm) and (16×5 mm)
Coverage degree	IP54 to EN 60529
Impact protection degree	IK 10 to EN 50102
Material	Polyester + glass fibre
Color	RAL 7035
Dimensions (H × W × D)	1300/1500/1700 × 245 × 264 mm
Height above the ground	700/900/1100 mm
Height above the ground incl. cable base	950/1150/1350 mm
Weight	14/17/20 kg

## ORDER CODES

Order Code	Name
85GB.10/0000F	MDP OZ 24/48
85GB.30/0000F	MDP OZ 48/96
85GB.50/0000F	MDP OZ 72/144
495630	Cable base (extension leg pillar)
85AV.04/0000	Tray KM 4
85AV.05/0000	Lid tray KM 4
495535	Tray KM 6
495536	Lid tray KM 6
85M9.16/0000	TS 12 splice holder (2 pcs needed for one KM 4)
495241	RIB 3 holder 3× ribbon or splitter 4× 4 mm (2 pcs needed for one KM 4)
85AV.94/0000F	Tray KM 5 complete
On request	PLC Splitter ABS

For other configurations will you please contact our sales department.

# MDP EL 96/192, MDP EL 144/288

OPTICAL PILLAR BOX

NEW

GPON READY

5G READY

FiberRoad

Optical pillar box MDP EL 96/192, 144/288 is designed for the placement of 96/144 SC connectors or 192/288 LC connectors outdoors. The pillar is to be installed in open space in trench. The cabinet is supplied without the splice trays. The solution is recommended for spliced GPON networks. Very robust design (reinforced thick walls).

- ▶ Very robust design (increased wall width)
- ▶ Three-point lock door
- ▶ Duct holder in the basement
- ▶ Cable rings for placing cable reserves
- ▶ Hingeable/detachable splicing/patching plate
- ▶ FiberRoad system
- ▶ Possibility of adding trays as your network grows
- ▶ Possibility of placing PLC splitters in the management (outside the trays)
- ▶ Possibility to combine trays KM 4, KM 5, KM 6
- ▶ Trays KM 4 and KM 6 for 24 splices
- ▶ Tray KM 5 for 12 SC or 24 LC connectors
- ▶ Optional ribbon splice holders
- ▶ Possibility of loop cable
- ▶ Max. 6 pcs PLC Splitters ABS for MDP EL 96/192 a 144/288



FiberRoad systém listovací

KM 6



KM 4



KM 5



MDP EL 144/288

# MDP EL 96/192, MDP EL 144/288

OPTICAL PILLAR BOX

NEW

GPON READY

5G READY

FiberRoad



## TECHNICAL SPECIFICATIONS

Entries	2× Express port II and 4× Express port I (4× 3–13 mm, 8× 3–9 mm, 54× 2–5 mm)
Coverage degree	IP 54 to EN 60529
Impact protection degree	IK 10 to EN 50102
Solar radiation (UV)	EN 60068-2-14
Material	Polyester + glass fibre
Color	RAL 7035
Dimensions MDP EL 96/192 H × W × D	1300 × 390 × 350 mm
Dimensions MDP EL 144/288 H × W × D	1500 × 390 × 350 mm
Weight	50 / 55 kg

## ORDER CODES

Order Code	Name
85FY.30/0000F	MDP EL 96/192
85FY.00/0000F	MDP EL 144/288
85AV.94/0000F	Tray KM 5 complete
85AV.04/0000	Tray KM4
85AV.05/0000	Lid tray KM4
495535	Tray KM6
495536	Lid tray KM6
85M9.16/0000	TS 12 splice holder (2 pcs needed for one KM4 or KM 6)
495241	RIB 3 holder 3× ribbon or splitter 4×4 mm (2 pcs needed for one KM4)
On request	PLC Splitter ABS

For other configurations will you please contact our sales department.

# ORM 96/144 F | WALL-MOUNTED OPTICAL DISTRIBUTION BOX

GPON READY

5G READY

The ORM 96/144 F optical distribution box is designed for the placement of 96 SC or 144 LC optical connectors indoors and outdoors.

- ▶ 4× EC2 splice tray on hinges for 24 splices (total 96 splices)
- ▶ Maximum capacity is 192 splices (8× EC2)
- ▶ Adaptor plate for 96 SC simplex or 36 SC duplex/LC quad
- ▶ Possibility of splitter holder (optional accessories)
- ▶ Possibility of lock (optional accessories)
- ▶ Plastic rings
- ▶ Holder of tension element

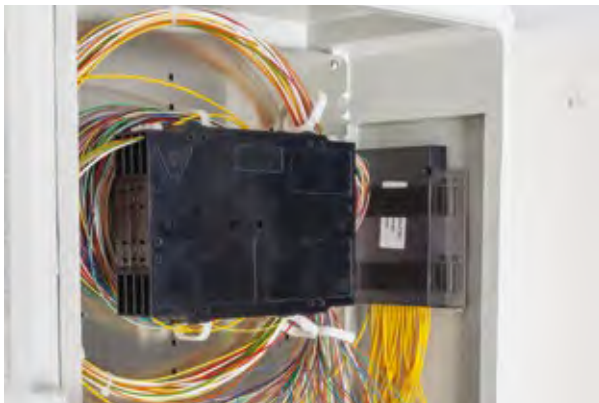

PLC splitter placement



## TECHNICAL SPECIFICATIONS

Bushings	3× PG16 (8–16 mm); 4× PG29 (24×3 mm)
Coverage degree	IP65 according to ČSN EN 60529
Self-extinguishing degree	HB according to UL 94
Impact protection degree	IK 08 according to ČSN EN 50102
Material	ABS
Color	Light Gray RAL 7035
Dimensions	500 × 400 × 175 mm
Weight	9 kg

## RECOMMENDED ACCESSORIES

Splice trays (EC2) page 071

PG 29/24×3 PAGE 072

Other accessories on the pages 067, 071, 072, 073, 075, 076

## ORDER CODES

Order Code	Name
85FX.00/0000F	ORM 96/144 F
85FX.06/0000F	Splitter holder
On request	Splitter ABS
495405	Lock (optional accessories, 2 pieces required)

For other variants, please, contact our sales department.

NEW
GPON READY
5G READY
FiberRoad

Optical distribution box MDB FA 144/192/288S is designed for the placement of 144/192/288 optical splices indoors and outdoor. The distribution box can be extended by a pole holder. A very suitable solution for spliced GPON networks.

- ▶ Maximum capacity of 144/192/288 splices
- ▶ Cable rings
- ▶ Placement of a large slack inside the cable management
- ▶ Removable splicing part
- ▶ FiberRoad system
- ▶ Modular capacity increase
- ▶ Possibility of placing PLC splitters inside the management (outside the trays)
- ▶ KM 4 trays for 24 splices
- ▶ Possibility of using ribbon fibers



MDB FA 288S

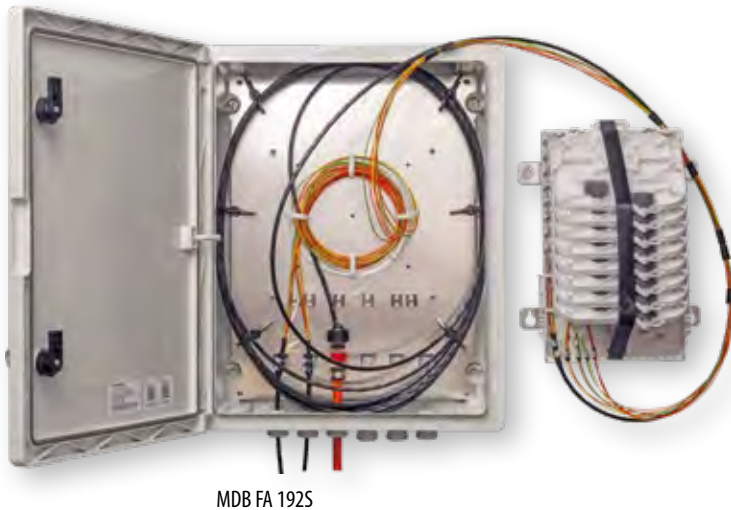

MDB FA 192S



MDB FA 144S

### TECHNICAL SPECIFICATIONS

Inputs	6× PG16 (8–16 mm)
Coverage degree	IP 65 to EN 60529
Impact protection degree	IK 08 to EN 50102
Self-extinguishing degree	HB to UL 94
Material	ABS
Color	Light grey RAL 7035
Dimensions MDB FA 144S (H × W × D)	400 × 300 × 165 mm
Dimensions MDB FA 192S (H × W × D)	500 × 400 × 175 mm
Dimensions MDB FA 288S (H × W × D)	600 × 400 × 200 mm
Weight	4 / 5.5 / 6.5 kg

### ORDER CODES

Order Code	Name
85TA.00/0000F	MDB FA 144S
85TA.10/0000F	MDB FA 192S
85TA.20/0000F	MDB FA 288S
495405	Key lock (2 pcs needed for one box)
85AV.04/0000	Tray KM 4
85AV.05/0000	Lid for KM 4
495535	Tray KM 6
495536	Lid tray KM 6
85M9.16/0000	Splice holder TS12 (2 pcs needed for one KM 4)
495241	Holder 3× ribbon or splitter 4× 4 mm RIB 3

For other variants, please, contact our sales department.

### FiberRoad stackable

KM 6



KM 4



# MDB FA 24/48, MDB FA 48/96, MDB FA 72/144 | OPTICAL DISTRIBUTION BOX

NEW

5G READY

FiberRoad

Optical distribution box MDB FA 24/48, 48/96, 72/144 is designed for the termination of 24/48/72 fibers to SC connectors or 48/96/144 fibers to LC connectors indoors and outdoors. The distribution box can be enhanced by the pole holder and it can store large cable/patchcord reserves.

- ▶ Maximum capacity 24/48/72 SC or 48/96/144 LC
- ▶ Ranging rings
- ▶ Possibility of storing large cable/patchcord reserves inside the distribution box
- ▶ Removable splicing/patching part
- ▶ FiberRoad system
- ▶ Possibility of modular increasing of the capacity
- ▶ Possibility of placing PLC splitter in the management section (outside the tray)
- ▶ Trays KM 5 for 24 splices and 12 SC simplex or LC duplex
- ▶ Hinging KM 5 tray for a better handling
- ▶ Possibility of ribbon fibers



MDB FA 72/144



MDB FA 48/96



MDB FA 24/48

## TECHNICAL SPECIFICATIONS

Inputs MDB FA 24/48	3× PG16 (8–16 mm), 2× PG29 (24×3 mm)
Inputs MDB FA 48/96	4× PG16 (8–16 mm), 4× PG29 (24×3 mm)
Inputs MDB FA 72/144	4× PG16 (8–16 mm), 6× PG29 (24×3 mm)
Coverage degree	IP 65 to EN 60529
Impact protection degree	IK 08 to EN 50102
Self-extinguishing degree	HB to UL 94
Material	ABS
Color	Light grey RAL 7035
Dimensions MDB FA 24/48 (H × W × D)	400 × 300 × 165 mm
Dimensions MDB FA 48/96 (H × W × D)	500 × 400 × 175 mm
Dimensions MDB FA 72/144 (H × W × D)	600 × 400 × 200 mm
Weight	4/5.5/6.5 kg

## ORDER CODES

Order Code	Name
85TA.50/0000F	MDB FA 24/48
85TA.60/0000F	MDB FA 48/96
85TA.70/0000F	MDB FA 72/144
495405	Key lock (set of 2 pcs needed)
85AV.04/0000	Tray KM 4
85AV.05/0000	Lid for KM 4
85M9.16/0000F	Tray KM 5
495241	Ribbon holder 3× or splitter 4×4 mm RIB 3 (2 pcs for one KM 5)

For other variants, please, contact our sales department.



KM 5



FiberRoad cascade

# MODB 48 | INDOOR MULTIOPERATING BOX

GPON READY 5G READY

The MODB distribution box is designed to the multioperating solutions optical distributions in housing. It enables installation of any indoor technology of optical network. It consists of the area of termination of residential distribution, and of the area of common access operators to the residential distribution. The distribution boxes can be installed closely over each other. It has lockable indoor part with saved splices or splitters. There is a possibility of gradual addition of capacity of distribution box and of installing PLC splitters. The box enables to use splicing technology or technology of mechanical connectors. It is designed for indoor wall-mounting.

- ▶ Capacity of 48 optical connectors
- ▶ Connector holder SC simplex
- ▶ Ideal solution for developer construction
- ▶ Separate party of provider from the residential distribution
- ▶ Common access operators to the residential distribution
- ▶ Fully compatible with PON or Point-to-Point architecture
- ▶ Possibility of installing any technology of residential distribution (EasyBend cables, riser cables, micro ducts, ribbon and loose tube cables)
- ▶ Possibility of placing splitters up to 3 pcs
- ▶ Easy and fast installation
- ▶ Stackability

## TECHNICAL SPECIFICATIONS

Material	Steel sheet
Colour	Light grey RAL 7035
Dimensions	441 × 172 × 113 mm
Weight	3.1 kg

## RECOMMENDED ACCESSORIES

Other accessories on the pages 067–076



## ORDER CODES

Order Code	Name
85MV.00/000CF	MODB 48

For other variants, please, contact our sales department.

# POR 48 | INDOOR OPTICAL DISTRIBUTION BOX

5G READY

Wall mounted fiber optical box is designed for the placement of up to 48 optical connectors indoor. Optical cables can be lead in/out from upsite or downsite. Adapters plate is selectable and splicing tray is removable and suitable for field operation and maintenance of up to 24 splices (heat shrink or crimp).

- ▶ Maximum capacity 24 SC or 48 LC connectors
- ▶ Optional splice tray EC2 or KM 1
- ▶ Placement of optical fibre reserves-2 ranging eyes
- ▶ Cable holders
- ▶ Rubber bushings
- ▶ Two lockable doors – two different locks
- ▶ Outdoor version available upon request
- ▶ Different capacities on request

## TECHNICAL SPECIFICATIONS

Material	Steel sheet
Colour	Light gray RAL 7035
Dimensions	421 × 316 × 64 mm
Weight	4 kg

## RECOMMENDED ACCESSORIES

Other accessories on the pages 067–075

## ORDER CODES

Order Code	Name
85CR.00/0000F	POR 48

For other variants, please, contact our sales department.



# ORU 1, 2, 3 ORU 1, 2, 3 SIS

## OPTICAL DISTRIBUTION BOX/PILLAR

GPON READY

5G READY

SAFeTNET

The optical distribution box ORU 1, 2, 3 / SIS is designed as a multi-purposed distributor with hinged rack for assembly up to 4, 16, 24 splice modules SAFeTNET for terminating or connecting of optical cables in micro-ducts or HDPE protecting pipes. Its construction enables using indoors and outdoors as well. With a simple holder it could be mounted on a pillar. The ORU 1, 2, 3 SIS are installed in an open area in trench.

- ▶ Maximum capacity 144, 576, 864 optical splices
- ▶ Maximum connected capacity 48, 192, 288 subscribers (2 fibers for a subscriber)
- ▶ Maximum number of splice modules SAFeTNET 4, 16, 24 pcs.
- ▶ Placement of optical fiber reserve, length 2.15 m, 3 m, 4 m
- ▶ Possibility of connector panel installation for measurement
- ▶ Possibility of oval bushing installation for undivided cable (so-called „OMEGA“)
- ▶ Different versions of the basement, high 300, 500, 600, 700, 900 mm
- ▶ Removable roof



### TECHNICAL SPECIFICATIONS

	ORU 1/SIS	ORU 2/SIS	ORU 3/SIS
Bushings	4× rubber bushing ø 30 mm 3× rubber bushing ø 50 mm	3× rubber bushing ø 30 mm 5× rubber bushing ø 50 mm 1× PG29 (12×3 mm); 3× PG13.5 (8–12 mm)	12× rubber bushing ø 50 mm
Coverage degree	IP 54 to EN 60529		
Self-extinguishing degree	V0 to UL94		
Impact protection degree	IK 10 to EN 50102		
Solar radiation (UV)	EN 60068-2-5		
Colour	Light grey RAL 7035		
Material – distribution box	Glass reinforced polyester SMC		
Material – bushings	PA6/PVC		
Material – metallic parts	Aluminium		
Dimensions	500 × 390 × 350 mm 1200 × 390 × 350 mm	500 × 550 × 350 mm 1200 × 550 × 350 mm	900 × 550 × 350 mm 1600 × 550 × 350 mm
Weight	14 kg / 39 kg	20 kg / 45 kg	23 kg / 53 kg

### ORDER CODES

Order Code	Name
8507.00/000NF	ORU 1
8507.00/000SF	ORU 1 SIS
8508.00/000NF	ORU 2
8508.00/000SF	ORU 2 SIS
8509.00/000NF	ORU 3
8509.00/000SF	ORU 3 SIS
8521.08/BALOF	Post Brackets

For other variants, please, contact our sales department.

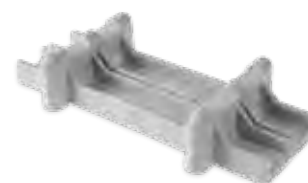

POST BRACKETS



UNDERGROUND BASE



# ORU 1 SDF SIS ORU 5 SDF SIS / ABS

OPTICAL DISTRIBUTION BOX/PILLAR

GPON READY 5G READY SAFeTNET

ORU 1 SDF SIS / ORU 5 SDF SIS is designed as splitter concentrator pillar distributor with hinged rack for assembly up to 4/12 splice modules SE for terminating or connecting of optical cables in micro-ducts or HDPE protecting pipes. Its construction enables using outdoors as well. It is installed in an open space in trench.

- ▶ Maximum capacity 144/432 optical splices
- ▶ Maximum connected capacity 64/288 optical fibers
- ▶ Maximum number of splice modules SAFeTNET 4/12 pcs.
- ▶ Capacity of splitters 2/5 pcs
- ▶ Placement of optical fiber reserve, length 4 m
- ▶ Different versions of the basement, high 300, 500, 600, 700, 900 mm
- ▶ Removable roof
- ▶ Possibility of placing ABS splitter

YouTube



LGX module with splitter

PLC ABS splitter shelf

## TECHNICAL SPECIFICATIONS

Bushings	3/5× PG48 (36–44 mm); 2/6× PG13.5 (8–12 mm); 2× PG29 (15–25 mm); 1× PG9 (5–8.5 mm)
Coverage degree	IP 54 to EN 60529
Solar radiation (UV)	EN 60068-2-5
Colour	Light grey RAL 7035
Material – distribution box	Glass reinforced polyester SMC
Material – bushings	PA6/PVC
Material – metallic parts	Aluminium
Dimensions	1200 × 390 × 350 mm / 1600 × 550 × 350 mm
Weight	44.5 kg / 53 kg

## ORDER CODES

Order Code	Name
8508.60/5000F	ORU 1 SDF SIS (with rubber bushings)
8508.28/0000F	ORU 5 SDF SIS
85MF.05/000HF	LGX module for splitter
8508.A3/0SESF	Connector plate splitter assembly
8508.A4/0000F	Modul for ABS splitter

For other variants, please, contact our sales department.



ORU 1 SDF SIS



ORU 5 SDF SIS



ORU 5 SDF SIS ABS



UNDERGROUND BASE

# ORU 9 SDF SIS | OPTICAL DISTRIBUTION BOX/PILLAR

GPON READY 5G READY ORSM

Optical distribution box ORU 9 SDF SIS is a new generation of street cabinets for PON-type optical network. The cabinet is freestanding, dustproof with the ruggedized structure against damage. Perfectly accessible and flexible. At the same time offers high-quality integrated modular optical management for terminating or connecting of optical cables in micro-ducts or HDPE protecting pipes. The construction of the cabinet allows its using in outdoor environments. The cabinet is installed in an open area in trench.

- ▶ Number of modules 12
- ▶ Capacity of modules 12× SC/E2000/SX or 12× LC/duplex adapters
- ▶ Capacity of max. 144/288 optical splices
- ▶ Maximum connected capacity of subscribers 144 in SC or 288 in LC connectors
- ▶ Number of splitters 6
- ▶ Placement of optical fiber reserve, length 5 m
- ▶ Basement high 600 mm
- ▶ Rubber bushing 6× ø 50 mm
- ▶ Three-point lock of front door
- ▶ Use for fibers G652D, G657A
- ▶ Modular concept
- ▶ Easy assembly and disassembly
- ▶ Safe fixation of micro ducts or HDPE tubes
- ▶ Secure compliance of the prescribed minimum bending radius of optical fibers
- ▶ Removable roof



## TECHNICAL SPECIFICATIONS

Bushings	6× rubber bushing ø 50 mm
Coverage degree	IP 54 to EN 60529
Self-extinguishing degree	V0 to UL94
Impact protection degree	IK 10 to EN 50102
Solar radiation (UV)	EN 60068-2-5
Change of temperature	-40 °C/+70 °C to EN 60068-2-14
Colour	Light grey RAL 7035
Material – cabinet	Glass reinforced polyester SMC
Material – metallic parts	Aluminium
Dimensions – cabinet + basement	1600 × 550 × 350 mm
Dimensions – base	700 × 550 × 350 mm
Weight	53 kg

## ORDER CODES

Order Code	Name
85CP.00/0000F	ORU 9 SDF SIS
85CP.00/00SPF	ORU 9 SDF SIS for ABS splitter
85MF.05/000HF	LGX module for splitter
8508.A4/0000F	Modul for ABS splitter
85CP.11/0000	Panel for splitters 4U
85CP.07/0000F	LGX splitter panel

For other variants, please, contact our sales department.



UNDERGROUND BASE

# ORU 9D SDF SIS | OPTICAL DISTRIBUTION BOX/PILLAR

GPON READY 5G READY ORSM

Optical distribution box ORU 9 D SDF SIS is a new generation of street cabinets for PON-type optical network. The cabinet is freestanding, dustproof with the ruggedized structure against damage. Perfectly accessible and flexible. At the same time offers high-quality integrated modular optical management for terminating or connecting of optical cables in micro-ducts or HDPE protecting pipes. The construction of the cabinet allows its using in outdoor environments. The cabinet is installed in an open area in trench

- ▶ Number of modules 24
- ▶ Capacity of modules 12× SC/SX or 12× LC/duplex adapters
- ▶ Capacity of max. 536 optical splices
- ▶ Maximum connected capacity of subscribers 512 in LC connectors
- ▶ Number of splitters 8
- ▶ Placement of optical fiber reserve, length 5 m
- ▶ Basement high 700 mm
- ▶ Rubber bushing 12× ø 50 mm
- ▶ Three-point lock of front door
- ▶ Use for fibers G652D, G657A
- ▶ Modular concept
- ▶ Easy assembly and disassembly
- ▶ Safe fixation of micro ducts or HDPE tubes



LGX module with splitter



PLC ABS splitter shelf

## TECHNICAL SPECIFICATIONS

Bushings	12× rubber bushing ø 50 mm
Coverage degree	IP 54 to EN 60529
Impact protection degree	IK 10 to EN 50102
Self-extinguishing degree	V0 to UL94
Solar radiation (UV)	EN 60068-2-5
Change of temperature	-40 °C/+70 °C to EN 60068-2-14
Colour	Light grey RAL 7035
Material – cabinet	Glass reinforced polyester SMC
Material – metallic parts	Aluminium
Dimensions – cabinet + basement	1600 × 1100 × 350 mm
Dimensions – base	600 × 1100 × 350 mm
Weight	90 kg

## ORDER CODES

Order Code	Name
On request	ORU 9D SDF SIS
85T2.48/0SALF	Modul ORSM 1 SC/APC – 12F
85T2.48/0LALF	Modul ORSM 1 LC/APC – 24F
85T2.48/POCEF	Splicing module ORSM 1
85MF.05/000HF	LGX module for splitter
8508.A4/0000F	Modul for ABS splitter
85CP.07/0000F	LGX splitter panel
85CP.12/0000F	Panel for 2× ABS modules
85CP.41/0002F	Rack 1U, 18", 12× SC, 1× LGX module
85CP.42/0000F	Rack 1U, 18", 12× SC, 1× ABS module

For other variants, please, contact our sales department.



DOUBLE UNDERGROUND BASE

GPON READY

5G READY

ORSM

ORU 8 SDF SIS is a new generation of street cabinets for PON-type optical network. The cabinet is freestanding with the ruggedized structure against damage. Perfectly accessible and flexible. At the same time offers high-quality integrated modular optical management for terminating or connecting of optical cables in micro-ducts or HDPE protecting pipes. The construction of the cabinet allows its using in outdoor environments. The cabinet is installed in an open area in trench.

- ▶ Number of modules 42
- ▶ Capacity of modules 12× SC/E2000/SX or 12× LC/duplex adapters
- ▶ Capacity of 504/1008 optical splices
- ▶ Maximum connected capacity subscribers 480 in SC or 960 in LC connectors
- ▶ Maximal PLC splitter capacity 16 splitters (LGX type)
- ▶ Placement of optical fiber reserve, length 5 m
- ▶ Three-point lock
- ▶ Sophisticated holder for microducts or HDPE tubes

YouTube



### TECHNICAL SPECIFICATIONS

Bushings	12× rubber bushings ø 50 mm
Coverage degree	IP 54 to EN 60529
Impact protection degree	IK 10 to EN 50102
Solar radiation (UV)	EN 60068-2-5
Change of temperature	-40 °C/+70 °C to EN 60068-2-14
Colour	Light grey RAL 7035
Material – cabinet	Glass reinforced polyester SMC
Material – metallic parts	Aluminium
Dimensions – cabinet + basement	1525 × 1090 × 450 mm
Dimensions – base	600 mm
Weight	90 kg

### ORDER CODES

Order Code	Name
85AD.00/0000F	ORU 8 SDF SIS
85MF.10/000HF	Module for splitters 142

For other variants, please, contact our sales department.



LGX module with splitter

PLC ABS splitter shelf

GPON READY

5G READY

ORSM

Optical distribution box/pillar for PON type optical networks. It allows connection of up to 288 participants in 24 modules with 12 SC adapters. For the backbone cable, there are two additional modules at the top. All the modules can be mounted in a hinged frame. Cabinet includes integrated holder for 11 PLC splitters in ABS housing, management for patchcords and parking element for unused connectors. The cabinet – pillar version is installed in an open area in trench.

- ▶ Number of modules 26 pieces, possibility of gradual expansion
- ▶ Capacity of 12× SC-SX or 12× LC/duplex adapters
- ▶ Maximum capacity is 288/576 + 24/48 SC/LC ports
- ▶ Maximum capacity for subscribers is 288/352 for SC/LC (max. 11 PLC splitters)
- ▶ Maximum capacity of 624 splices
- ▶ Integrated holder for 11 PLC splitters in ABS housing (max. splitter 1:32)
- ▶ Patchcord management
- ▶ Folding frame for comfortable installation
- ▶ Wall, pole and pillar application
- ▶ The possibility of direct mounting into a trench without the need of concrete base



Connector parking element



### TECHNICAL SPECIFICATIONS

Bushings	6× PG16 (4×5 mm); 2× PG16 (10–14 mm)
Coverage degree	IP66 to ČSN EN 60529
Self-extinguishing degree	V0 to UL 94
Impact protection degree	IK 10
Solar radiation	ČSN EN 60068-2-5
Material	Glass reinforced polyester SMC + painting
Color	Light Gray RAL 7035
Dimension	816 × 616 × 323 mm / 1800 × 616 × 323 mm
Weight	40 kg / 60 kg

### ORDER CODES

Order Code	Name
85FD.50/0000F	FDH 288
85FD.00/0000F	FDH 288 SIS
495295	Set of wall brackets
495299	Set of pole brackets
85H2.05/BAL0F	Cable splitter 6× 5/3.5 mm
On request	Tube 5/3.5 mm
852X.90/000XF	Mounting shelf
85T2.48/0000F	Module empty
On request /	Module complete pre-installed, different types

For other variants, please, contact our sales department.



Cable/duct management view

NEW GPON READY 5G READY

FIBREGUARD™ Closure, is a reliable and competitive solution for data, voice and video transmission. It is designed for all types of cables: ADSS, OPGW and underground, providing users with professional versatility. The FIBREGUARD™ closure can be used in many types of installations: towers, wooden or concrete poles, aerial strand, manholes, and directly buried. For all installations the appropriate fittings are available as a separately purchased kit.

- ▶ Will accommodate fusion, mechanical and ribbon splicing
- ▶ Many applications: Head end, splice box, node, cable termination point, and terminal and branch splice application
- ▶ Easy and quick installation, taking less than 10 seconds to be re-entered
- ▶ Rubber bushings – single or multiple entries, which are selected according to cable diameter
- ▶ Air and water tightness
- ▶ There is a strength member and cable fastening system for each cable entry port

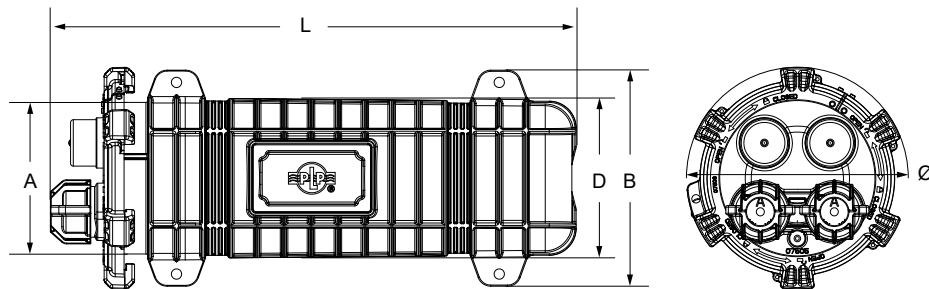

### DIMENSIONAL CHARACTERISTICS

Type	Express ports	Single ports	L	Ø	D	A	B
(mm)							
FIBREGUARD™ 500	2x1.8/25mm	2x1.8/25mm	515	209	147	134	206
FIBREGUARD™ 650	2x1.8/25mm	3x1.8/25mm	622	241	184	167	234
FIBREGUARD™ 800	2x1.8/25mm	5x1.8/25mm	664	279	222	205	273
FIBREGUARD™ 800S	2x1.8/25mm	5x1.8/25mm	460	279	222	205	273

They have also been designed to host different fiber management systems, and in this way they accept:

- ▶ Slide & lock splice trays (also known as book type);
- ▶ SAFeNET® Fiber Management system for single circuit/single element applications (only FIBREGUARD™ 800 splice closures)
- ▶ Stackable COYOTE® splice trays applications (only FIBREGUARD™ 650 and FIBREGUARD™ 800 splice closures)

### Slide & lock splice trays

The SLIDE & LOCK® Splice trays offer a simple and craft-friendly design, which allows entrance into any tray independently of its position inside the closure, as you do not have to move the trays that are immediately above. For this purpose, every tray has flip tray devices, which enable to pull up the above trays holding them in position. Simply push the tray back and pull them up until they remain in place. Then you can reach the tray you want with no risk of fibers. Additionally, the block of trays may be turned either on the right or on the left, so you can work in the fibers, not being disturbed by the holding stud. Every tray can host up to 12 or 24 fusion splices, and even up to 72 splices with several entries, which will allow you to make different operations like splicing, expressing fibers, segregating and storing dark fibers.

### CAPACITY OF THE FIBREGUARD™ CLOSURES WITH SLIDE & LOCK™ SPLICE TRAYS

Picture	No. of splices	Number of splice trays per closure			
		FBG-500	FBG-650	FBG-800S	FBG-800
1	18	4	5	8	9
2	36	4	5	8	9
3	24	X	5	8	9
4	72	X	4	X	8



### RANGE OF STANDARD EXISTING GROMMETS

Type	Range of application	Cable entries
A	10 – 15 mm	1
B	15 – 21 mm	1
C	21 – 25 mm	1
2-H	7 – 11 mm	2
3-H	7 – 11 mm	3
4-H	3 – 7 mm	4
8-H	3 – 7 mm	8
8-H	4 – 8 mm	8
12-H	3.5 – 4.5 mm	12
24-H	1.8 – 2.5 mm	24

NEW GPON READY 5G READY SAFeTNET

### SAFeTNET® Fiber management system

The FIBREGUARD™ Closure have also been designed to host different fiber management systems, and in this way they accept SAFeTNET® Fiber Management system for single circuit/single element applications.

This fiber management allows the operator to have the flexibility to manage their fiber network in many different ways. It can adapted expressing fibers either individually (Single Circuit), by the element or even fibers from different tubes.

The SAFeTNET® Fiber management system is based on just three main components:

- ▶ The buffer tube storage area
- ▶ The fiber Distribution Module
- ▶ Single Element (SE) or Single Circuit (SC) splice trays
- ▶ Controlled fiber bend management throughout the whole module stack
- ▶ No retubing of fibers

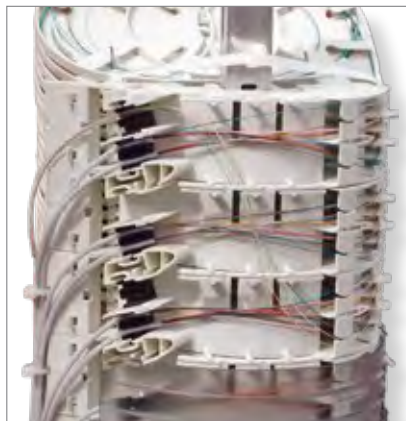

### ▶ CAPACITIES OF THE SPLICE CLOSURES FIBREGUARD™ 800 USING SAFeTNET® FIBER MANAGEMENT SYSTEM

Type	SE	8-count SE	SC
FIBREGUARD™ 800	432	576	144/288
FIBREGUARD™ 800S	216	288	72/144



1



2



3

### ▶ ORDER CODES

Order Code	Name	Position
490376	Subscriber unit kit SC for 36 splices	1
490375	Element unit kit SE for 36 splices	2
8506.59/0000F	SS splice trays module	3

For other version of COYOTE Closures please see PLP catalogue or visit [www.preformed.com](http://www.preformed.com)

# MUC 160 MUC 250

## UNDERGROUND CHAMBER WITH AN OPTICAL DISTRIBUTION BOX

GPON READY

5G READY

The MUC 160 / MUC250 underground chamber offers a cost effective solution for connecting fibres in FTTx networks. It is installed exclusively on the customer's land and is used for the installation and protection of spares and the subsequent connection of fibres. The chamber is designed for micro duct systems.

- ▶ Easy installation
- ▶ Load-free chamber for use on the customer's land (MUC 160)
- ▶ Without lock / Screw lock
- ▶ The ORM 3 distribution box is fixed to a stainless steel holder under the lid
- ▶ Capacity of 12/24 optical splices
- ▶ Integrated fibre management
- ▶ Possibility of the installation 1:4 or 1:8 PLC splitter
- ▶ Used for fibres G.657 a,b
- ▶ Possible express port or PG bushings
- ▶ PG 7 bushings 3× Ø 2.5–6.5 mm
- ▶ Optional 6× PG bushings (MUC 250)
- ▶ Maximum capacity of 9/18 cables Ø 1.6–2.6 mm



YouTube



MUC 160



MUC 250

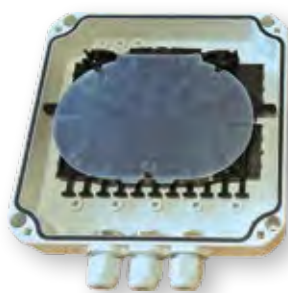

ORM 3 SL 125

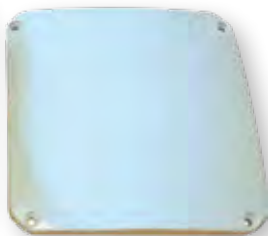

ORM 3 SH 24 S



### TECHNICAL SPECIFICATIONS

	MUC 160	MUC 250
MUC input	Open bottom, side openings	Open bottom, side openings
MUC dimensions	Lower Ø 205, Upper Ø 160, Height 235 mm	Lower Ø 335, Upper Ø 250, Height 265 mm
ORM 3 dimensions	136 × 136 × 46 mm	136 × 136 × 46 mm / 136 × 136 × 64 mm
MUC material	PP/PC, stainless steel / PP/PC	HDPE, stainless steel
ORM 3 material	PC/ABS, ENSOFT	PC/ABS, ENSOFT
Colour	Green, grey, black	Green, grey
ORM 3 protection class	IP67 according to ČSN EN 60529	IP67 according to ČSN EN 60529
Weight / Hmotnost	1.5 kg	2.5 kg

### RECOMMENDED ACCESSORIES

85BV.25/0000F	PG7 (3–6.5 mm) bushing
494117	Sealing insert for PG7 3× Ø 1.6–2.6 mm
347800	Silicone plug Ø 1.59–3.17 mm

### ORDER CODES

Order Code	Name
85BD.10/0000F	MUC 160 SL 125 PG
85BE.16/0000F	MUC 250 SH 24S PG

For other variants, please, contact our sales department.



The MUC underground chambers offer a comprehensive fibre junction solution in the distribution points in FTTx networks. The boxes are placed in diving bell in the chamber to prevent the access of underground water into the boxes.

- ▶ Lid for load of up to 12.5t/m<sup>2</sup> (Optional accessory)
- ▶ Screw lock
- ▶ Quick opening and closing of the optical distribution box without the loss IP 68 protection
- ▶ Management of cable reserve
- ▶ Inputs: Open bottom or according to chamber base
- ▶ Material polypropylene, stainless steel
- ▶ Colour black, grey
- ▶ Coverage degree IPX8 according to ČSN EN 60529

### RECOMMENDED ACCESSORIES

Other accessories on the page 047



## MUC 315B

GPON READY 5G READY

- ▶ Designed for micro duct systems up to Ø 12 mm
- ▶ 4x duct holders in the lower part
- ▶ Chamber base with 2 or 4 entries for cable protection tube Ø 110 mm (Optional accessory)
- ▶ Maximum capacity 96 splices with box F-BOX 96S
- ▶ Maximum capacity 18x SC adapters and 48 splices with box F-BOX 48S 18SC
- ▶ Dimensions: Inside Ø 315, outside Ø 400, height 580 mm, height with base 720 mm
- ▶ Weight 8 kg

Boxes can be modify upon a request.



F-BOX 48S 18SC



F-BOX 96S



YouTube



EN 1



EN 2

### ORDER CODES

Order Code	Name
85BF.30/0000F	MUC 315B F-BOX 96S
85BF.31/0000F	MUC 315B F-BOX 48S 18SC

For other variants, please, contact our sales department.

# MUC 425B

GPON READY 5G READY

- ▶ Designed for micro duct systems up to  $\varnothing$  16 mm
- ▶ 4x duct holders in the lower part
- ▶ Chamber base with 2 or 4 entries for cable protection tube  $\varnothing$  110 mm (Optional accessory)
- ▶ Maximum capacity 192 splices with box F-BOX 192S
- ▶ Dimensions: Inside  $\varnothing$  425, outside  $\varnothing$  480, height 600 mm, height with base 800 mm
- ▶ Weight 12 kg

Boxes can be modify upon a request.



F-BOX 192S



## ORDER CODES

Order Code	Name
85BG.40/0000F	MUC 425B F-BOX 192S

For other variants, please, contact our sales department.

# MUC 600B

GPON READY 5G READY

- ▶ Chamber base for the cable protection tube  $\varnothing$  160 mm (Optional accessory)
- ▶ Maximum capacity 336 splices with box F-BOX 336S
- ▶ Dimensions: Inside  $\varnothing$  600, outside  $\varnothing$  700, height 650 mm, height with chamber base 870mm
- ▶ Weight 18 kg

Boxes can be modify upon a request.



F-BOX 336S



## ORDER CODES

Order Code	Name
85BR.40/0000F	MUC 600B F-BOX 336S

For other variants, please, contact our sales department.

# ACCESSORIES for Underground chamber

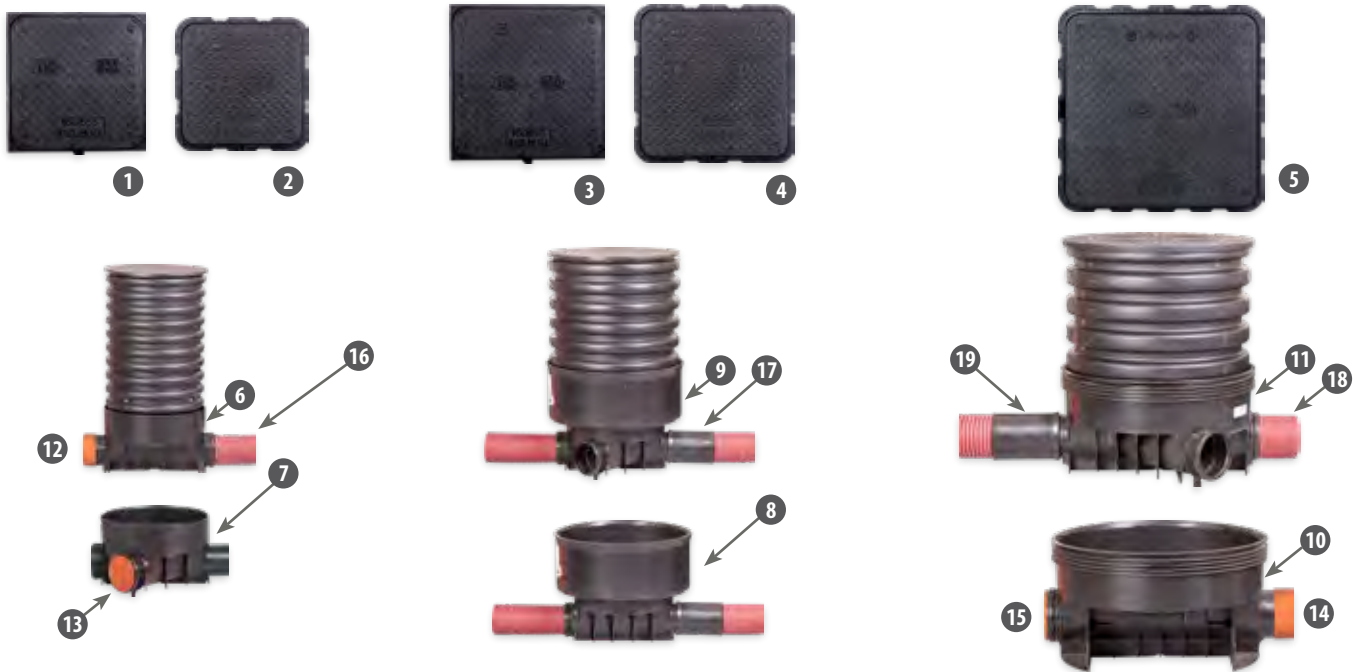

## ORDER CODES

Order Code	Name	Position
85BR.95/0000F	Composite lid for pavement (12.5 t/m <sup>2</sup> ) for MUC 315	1
493808	Composite lid for asphalt (12.5 t/m <sup>2</sup> ) for MUC 315	2
85BR.96/0000F	Composite lid for pavement(12.5 t/m <sup>2</sup> ) for MUC 425	3
493809	Composite lid for asphalt (12.5 t/m <sup>2</sup> ) for MUC 425	4
493810	Composite lid (12.5 t/m <sup>2</sup> ) for MUC 600	5
493924	Chamber base straight 2× Ø 110 mm for MUC 315	6
493925	Branching chambere base 4× Ø 110 mm for MUC 315	7
495354	Chamber base straight 2×160 mm for MUC 425	8
495353	Branching chambere base 4× Ø 160 mm for MUC 425	9
494221	Chamber base straight 2× Ø 160 mm for MUC 600	10
494222	Branching chamber base 4× Ø 160 mm for MUC 600	11
493927	Cap for entry point Ø 110 mm for MUC 315	12
493926	Plug for entry point Ø 110 mm for MUC 315	13
*	Cap for entry point Ø 160 mm for MUC 600	14
*	Plug for entry point Ø 160 mm for MUC 600	15
493949	Protection tube 50 m Ø 110 mm for MUC 315 and 425	16
493950	Protection tube joint Ø 110 mm for MUC 315 and 425	17
*	Protection tube 25 m Ø 160 mm for MUC 600	18
*	Protection tube joint Ø 160 mm for MUC 600	19
85BH.17/0000F	Set of 3 sealing inserts 2-3 mm incl. frame and plugs	20
85BH.17/0100F	Set of 3 sealing inserts Ø 3-4 mm incl. frame and plugs	
85BH.17/0200F	Set of 3 sealing inserts Ø 4-5 mm incl. frame and plugs	
85BH.17/0300F	Set of 3 sealing inserts Ø 5-6 mm incl. frame and plugs	
85BH.17/0400F	Set of 3 sealing inserts Ø 6-7 mm incl. frame and plugs	
85BH.17/0500F	Set of 3 sealing inserts Ø 7-8 mm incl. frame and plugs	
85BH.17/1300F	Set of 3 sealing inserts Ø 8-9 mm incl. frame and plugs	
85BH.17/1400F	Set of 3 sealing inserts Ø 9-10 mm incl. frame and plugs	
85BH.17/1500F	Set of 3 sealing inserts Ø 10-11 mm incl. frame and plugs	
85BH.17/1600F	Set of 3 sealing inserts Ø 11-12 mm incl. frame and plugs	
85BH.17/1700F	Set of 3 sealing inserts Ø 12-13 mm incl. frame and plugs	
85BH.17/1800F	Set of 3 sealing inserts Ø 13-14 mm incl. frame and plugs	
85BH.17/1900F	Set of 3 sealing inserts Ø 14-15 mm incl. frame and plugs	
85BH.17/0800F	Set of 4 sealing inserts 4× Ø 2-3 mm incl. frame and plugs	
85BH.17/0900F	Set of 4 sealing inserts 4× Ø 3-4 mm incl. frame and plugs	
85BH.17/1000F	Set of 4 sealing inserts 4× Ø 4-5 mm incl. frame and plugs	
85BH.17/1100F	Set of 4 sealing inserts 4× Ø 5-6 mm incl. frame and plugs	
85BH.17/0600F	Grommet M50 76× Ø 1.5-2.6 mm and 2× Ø 2.5-5mm	22
85BH.17/0700F	Grommet M50 19× Ø 3.2-6.5 mm	23

\*) On request | For other variants, please, contact our sales department.



# MICRO DUCT SYSTEM

Microduct system is designed for modular construction of optical networks – an effective solution for urban areas, energy, industrial and commercial zones.

## ORDER CODES

Order Code	Name	Position
On request	Thin-walled microducts different types	1
On request	Thick-walled microducts different types	2
On request	Microducts bundles different types	3
On request	Microducts strip different types	4
On request	Protection tube for HDPE different types	5

For other variants, please, contact our sales department.



## ORDER CODES ACCESSORIES FOR HDPE AND FOR MICRODUCTS

Order Code	Name	Position	Order Code	Name	Position
710221	MT Gas block connector, 5, cable 0.5 to 3	1	710133	MT End cap, 12	25
710222	MT Gas block connector, 7, cable 0.5 to 3	2	710108	MT End cap, 14	26
710223	MT Gas block connector, 7, cable 3 to 5	3	*	MT Female plug, 5	27
710224	MT Gas block connector, 10, cable 0.5 to 3	4	710145	MT Female plug, 7/8	28
710225	MT Gas block connector, 10, cable 3 to 6	5	710146	MT Female plug, 10	29
710226	MT Gas block connector, 10, cable 6 to 8	6	710147	MT Female plug, 12	30
710227	MT Gas block connector, 12, cable 3 to 6	7	710158	MT Female plug, 14	31
710228	MT Gas block connector, 12, cable 6 to 8	8	710128	MT Locking clip, 5	32
710229	MT Gas block connector, 12, cable 8 to 10	9	710127	MT Locking clip, 7	33
710230	MT Gas block connector, 14, cable 3 to 6	10	710122	MT Locking clip, 8	34
710231	MT Gas block connector, 14, cable 6 to 8	11	710126	MT Locking clip, 10	35
710232	MT Gas block connector, 14, cable 8 to 10	12	710125	MT Locking clip, 12	36
710131	MT Connector DB**, 7	13	*	MT Locking clip, 14	37
710130	MT Connector DB**, 10	14	710246	MT Gas block endcap, 7, cable 0.5 to 3	38
710129	MT Connector DB**, 12	15	710247	MT Gas block endcap, 7, cable 2.6 to 4	39
710189	MT Connector DB**, 14	16	710248	MT Gas block endcap, 7, cable 3 to 5	40
710144	MT Connector, 5	17	710249	MT Gas block endcap, 10, cable 0.5 to 3	41
710134	MT Connector, 7	18	710250	MT Gas block endcap, 10, cable 3 to 6	42
710136	MT Connector, 10	19	710251	MT Gas block endcap, 10, cable 6 to 8	43
710135	MT Connector, 12	20	710252	MT Gas block endcap, 12, cable 3 to 6	44
*	MT Connector, 14	21	710253	MT Gas block endcap, 12, cable 6 to 8	45
710143	MT End cap, 5	22	710254	MT Gas block endcap, 12, cable 8 to 10	46
710140	MT End cap, 7	23	710255	MT Gas block endcap, 14, cable 3 to 6	47
710121	MT End cap, 8	23	710256	MT Gas block endcap, 14, cable 6 to 8	48
710142	MT End cap, 10	24	710257	MT Gas block endcap, 14, cable 8 to 10	49

\*) On request | \*\*) DB – Direct bury | For other variants, please, contact our sales department.

# MUC Cube 320 | UNDERGROUND CHAMBER

**NEW**

The MUC Cube 320 is a purpose designed mini access box, or boundary box, that will cater for low fibre count connections. The MUC Cube 320 is normally used to connect MDU's or single use Clients from the network.

- ▶ Ideal for low density traffic installations. Depending on splitter configuration, up to 12 clients can be connected
- ▶ The unit can be split between base or pan and chamber section to allow installation over existing networks
- ▶ Low footprint unit 250 × 230 mm
- ▶ No tools required for assembly – press-on clips complete the assembly
- ▶ Duct ports are sealed with rubber grommets allowing interface with Multi-Duct and/or MicroDuct. No foaming agent or additional sealants are required
- ▶ Knock-down design allows high packing density for transport savings
- ▶ Hingeless slide-in lid with nylon lanyard



Products suitable for installation in MUC Cube 320 chamber:

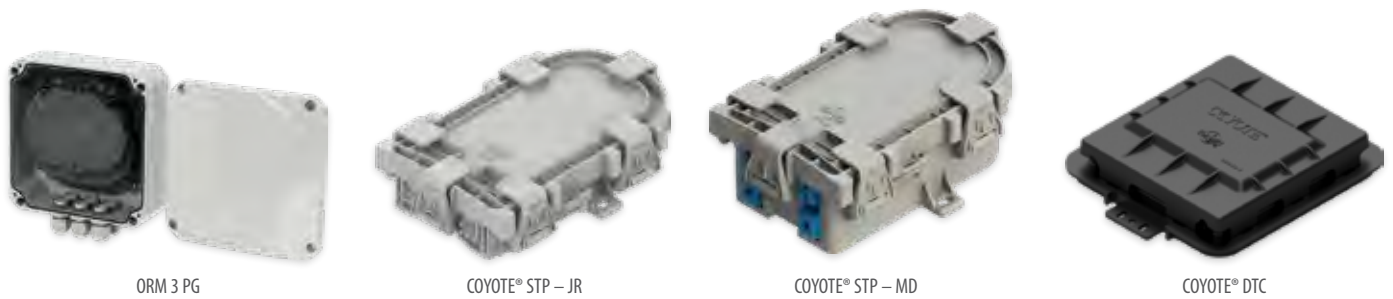

For more information, please, see PLP catalogue.

## TECHNICAL SPECIFICATIONS

Lid, box and base	PP, UV stabilised
Lock	PP, UV stabilised
O Ring	6 mm NBR
Clips	PP, UV stabilised
40 mm reducer cup	Rubber compound
Colour	Black
Dimensions	250 × 230 mm, Height 310 mm
Loading	1500 gg Downward Point load with 150 mm foot print



# MUC 400 | UNDERGROUND CHAMBER

**NEW**

The MUC 400 is a purpose designed mini Access Box, or Boundary Box, that will cater for medium fibre count connections. The MUC 400 is normally used to connect MDU's or multiple users to the network.

- ▶ Ideal for medium density traffic installations. Depending on splitter configuration, multiple clients can be connected
- ▶ The unit can be split between Base or Pan, and Chamber section to allow for installation over existing networks
- ▶ Small footprint diameter of 350 mm
- ▶ No tools required for assembly – press-on clips complete the assembly
- ▶ Duct ports are sealed with rubber grommets allowing interface with Multi-Duct and/or MicroDuct. No foaming agent or additional sealants are required (4x 50 mm ports) (2x 110 mm ports)
- ▶ Knock-down design allows high packing density for transport savings
- ▶ Hingeless slide-in lid with nylon lanyard
- ▶ No metal parts



Products suitable for installation in MUC 400 chamber:



ORM 3 PG



COYOTE® STP – JR



COYOTE® STP – MD



COYOTE® DTC



COYOTE® DTC4 & DTC6



COYOTE® DTC8

For more information, please, see PLP catalogue.

## TECHNICAL SPECIFICATIONS

Clips	PP, UV stabilised
Lock	PP, UV stabilised
O Ring / Lid	6 mm NBR
Base	PP, UV stabilised
Split Panels	Black / PP, UV stabilised
Dimensions	ø 350–450 mm, Height 600 mm
Loading	1500 kg Downward Point load with 250 mm foot print

# MUC 600 | UNDERGROUND CHAMBER

**NEW**

The MUC 600 is a modular composite solution offering the network builder unsurpassed flexibility, performance and economy. The Chamber section is an assembly of quarter segments.

- ▶ Modern composite design ensures high strength / low weight for installation cost savings
- ▶ Ideal for high fibre traffic installations – up to 2× 144 or 4× 48 Fibre Closures
- ▶ Splittable porting panels uniquely allow retrofitting to existing networks or new builds alike
- ▶ Easy assembly with basic hand tools only
- ▶ Unique multi-port knock-outs give industry leading interface with all Duct and Multiduct options
- ▶ Modular design allows various depth configurations
- ▶ DMC cover eliminates the threat of theft
- ▶ Full range of loading options available
- ▶ Modular knock-down design offers high packing density for transport savings



Products suitable for installation in MUC 600 chamber:



COYOTE® DTC4 & DTC6



COYOTE® 6.5" × 17"



COYOTE® DTC8



COYOTE® Dome 6.5" × 22"



COYOTE® In-Line RUNT



FIBREGUARD™



COYOTE® Dome 9.5" × 19"



COYOTE® ONE

## TECHNICAL SPECIFICATIONS

Panels	PP, UV Stabilised – Colour Black
Coping, Lid and Base	DMC – Colour Grey (DI available on request)
Fasteners	Stainless Steel / Nylon
Lock	Details on request
Slack bracket	PP
Slack bracket	PP
Loading Class As per EN124 Weight	A15-15kN 45 kg
	B125-125kN 45 kg
	C250-250kN 57 kg
	D400-400kN 66 kg
Dimensions	ø 750 mm, Height 700 mm



# ORMP 1U/2U | DRAW-OUT-TYPE ODF

GPON READY 5G READY

The ORMP draw-out-type ODF is designed for the placement of 24/48/72 optical connectors indoors. The design of the patch panel enables to install it into a 19" rack.

- ▶ Capacity of 24–72 optical connectors
- ▶ Connector panel 12/24/48/72 SC simplex, E2000
- ▶ Needle holder of optical splice trays
- ▶ Placement of optical fiber reserve
- ▶ Self-adhesive cable rings
- ▶ Possibility to fit it with PG bushings
- ▶ Adjustable mounting brackets
- ▶ Easy assembly
- ▶ Installation into a 19" base
- ▶ Height of 1U/2U

YouTube



1



2



3



4

## TECHNICAL SPECIFICATIONS

	ORMP 1U	ORMP 2U
Input/Output	2× PG16 (8×–16 mm); 2× PG9 (5–8.5 mm)	2× PG16 (8×–16 mm); 2× PG9 (5–8.5 mm)
Colour	Black RAL 9005	Black RAL 9005
Material – distribution box	Painted steel	Painted steel
Height	1U	2U
Dimensions	44 × 483 × 250 mm	88 × 483 × 250 mm
Weight	2.9 kg	3.5 kg

## ORDER CODES

Order Code	Name	Position
8A78.00/0005K	ORMP 1U	1
85HS.00/BK05F	ORMP 1U 12× SC/E2000	–
85HS.05/BK05F	ORMP 1U 24× SC/E2000	2
8A69.00/0005K	ORMP 2U	3
85HS.09/BK05F	ORMP 2U 48× SC/E2000	–
85HS.10/BK05F	ORMP 2U 72× SC/E2000	4

For other variants, please, contact our sales department.

## ORDER CODES

Order Code	Name	Position
8535.01/0005	Connector panel 6× E2000/SC	4
8535.02/0005	Connector panel 8× E2000/SC	5
8535.03/0005	Connector panel 12× E2000	–
8535.04/0005	Connector panel 6× ST/FC	–
8535.05/0005	Connector panel 8× ST/FC	6
8535.07/0005	Connector panel 6× SC duplex	–
8535.06/0005	Blinding connector panel	–

For other variants, please, contact our sales department.

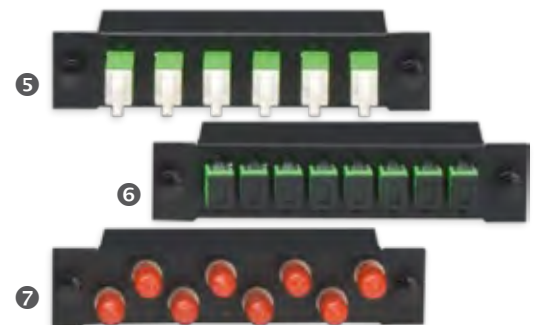



# ORSM 4/6 | MODULE ODF

GPON READY 5G READY ORSM

The optical distribution patch panel ORSM 4/6 and is designed for the placement of 72/144 or 36/72 optical connectors indoors in the central office. The concept of the distribution box enables to terminate and lead out all types of optical cables to the point of main optical node. The distribution patch panel is designed for the installation into 19" or 21" data cabinet.

- ▶ Capacity of 72/144 or 36/72 optical connectors
- ▶ Compose from 3 or 6 modules
- ▶ Module structure (12× SC simplex or 12× LC duplex adapters)
- ▶ Module contains space for pigtail reserve and tray for splicing
- ▶ Easy access into each module (possibility splicing out from the frame)
- ▶ Possibility placing E2000, SC simplex, LC duplex adapters
- ▶ Placement of up to 2 m of an optical fiber reserve
- ▶ Fixing standard optical cables or microcables (3–4 mm)
- ▶ Possibility of installing passive elements into the modules
- ▶ Installation into a data cabinet 19" or 21"
- ▶ Possibility of installation into 300 mm depth cabinet
- ▶ Recommended patchcords diameter 1.8 mm



YouTube

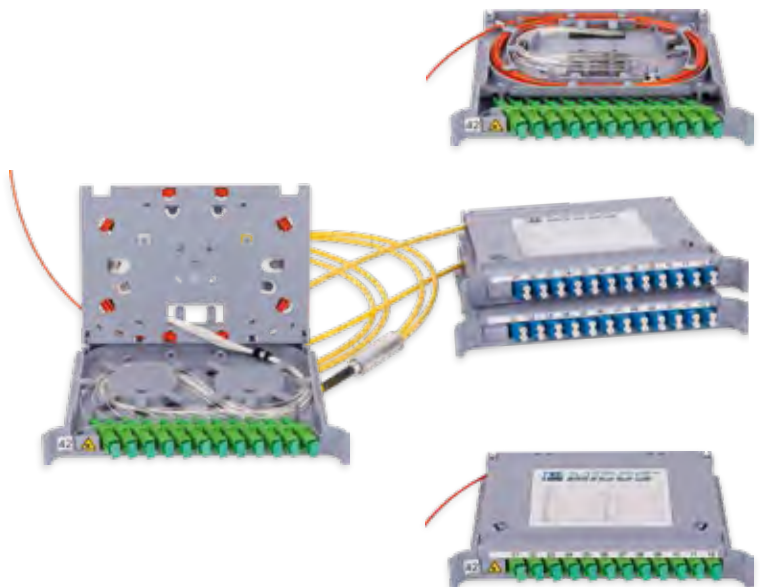

## TECHNICAL SPECIFICATIONS

	ORSM 4	ORSM 6
Height	4U	2U
Material	Painted Steel	Painted Steel
Colour	Light grey RAL 7035	Light grey RAL 7035
Dimensions	483 × 177 × 267 mm – 19" 535 × 177 × 267 mm – 21"	483 × 88 × 267 mm – 19"
Weight	4.4 kg	2.5 kg

## RECOMMENDED ACCESSORIES

Accessories on the pages 067–075

## ORDER CODES

Order Code	Name
85CU.10/0001F	ORSM 4/19/300
85CU.20/0001F	ORSM 4/21/300
85CU.70/0001F	ORSM 6/19/300

For other variants, please, contact our sales department.

# Splitter panel 1U/2U

1:32/1:64 WITH SC CONNECTORS

GPON READY

5G READY

▶ Panels are designed for storage 1× PLC splitter 1:32 (1U panel) or 1× PLC splitter 1:64 (2U panel). Splitter Input and outputs are connected to the front adaptor plate and are terminated on SC adaptors.

- ▶ Advanced planar technology
- ▶ Low loss and PDL
- ▶ Easy installation
- ▶ Ready for use – plug & play
- ▶ Used in PON networks to realize optical signal power splitting
- ▶ LHC splitter version = Large Hard Case

## Application

- ▶ FTTH/B Network
- ▶ CATV
- ▶ Data Communication



ORMP 1U 1:32



ORMP 2U 1:64

## TECHNICAL SPECIFICATIONS

	1U	2U
Material	Painted steel	Painted steel
Colour	Black RAL 9005	Black RAL 9005
Dimensions	44 × 483 × 250 mm	88 × 483 × 250 mm
Weight	3.3 kg	4 kg

## SPLITTER SPECIFICATIONS / SPECIFIKACE SPLITTERU

	1:32	1:64
Operation Wavelength (nm)	1260–1650	1260–1650
Fiber type	G657A	G657A
Insertion loss (dB)	≤ 17.3	≤ 21.8
Loss uniformity (dB)	≤ 1.6	≤ 2.0
PDL (dB)	< 0.2	< 0.3
Directivity (dB)	> 55	> 55
Return loss (dB)	> 60	> 60
Operation temperature (°C)	-40 ÷ +85	-40 ÷ +85
Storage temperature (°C)	-40 ÷ +85	-40 ÷ +85
Splitter size (mm)	120 × 80 × 18	140 × 114 × 18

## ORDER CODES

Order Code	Name
85DP.00/OBS5F	ORMP 1U 1:32 (without splitters)
8A78.70/OBV5F	ORMP 2U 1:64 (without splitters)

For other variants, please, contact our sales department.

# ORMPV 1U/2U/3U | HINGED ODF

GPON READY 5G READY

The ORMPV hinged module patch panel is designed for placing 48/96/144 optical connectors indoor. The design of the distributor enables installation on a 19" rack.

- ▶ Capacity of 48/96/144 optical connectors
- ▶ Connector holder SC simplex, ST, FC, E2000, LC, SC duplex
- ▶ Optical splice tray holder
- ▶ Placement of optical fiber reserve
- ▶ Self-adhesive cable rings
- ▶ Easy assembly
- ▶ Installation into a 19" base
- ▶ Possibility of rear fastening
- ▶ Side depth adjustable 19" mounting kit
- ▶ Height of 1U/2U
- ▶ Cable entrance from the back or the side

YouTube



ORMPV 2U

ADJUSTABLE MOUNTING KIT



ORMPV 1U

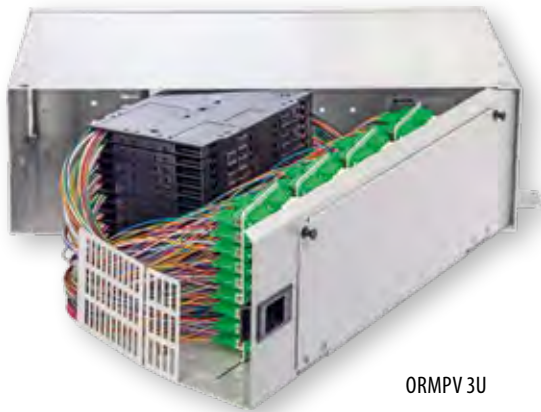

ORMPV 3U

## TECHNICAL SPECIFICATIONS

	ORMPV 1U	ORMPV 2U
Colour	Light grey RAL 7035	Light grey RAL 7035
Material – distribution box	Painted steel (Aluzinc)	Painted steel (Aluzinc)
Height	1U	2U
Dimensions	436 × 43 × 280 mm	436 × 88 × 282 mm
Weight	4 kg	5.2 kg

	ORMPV 3U
Colour	Light grey RAL 7035
Material – distribution box	Painted steel (Aluzinc)
Height	3U
Dimensions	465 × 132 × 269 mm
Weight	7 kg

## RECOMMENDED ACCESSORIES

- Splice trays
- Splice holders
- Lid

Other accessories on the pages 067–075

## ORDER CODES ORMPV 1U

Order Code	Name
8505.80/0AZCF	Without connectos panel
8505.07/000CF	Panel 24 × E2000
8505.09/000CF	Panel 36 × E2000
8505.12/000CF	Panel 12 × E2000
8505.65/000CF	Panel 12 × SC duplex/QUADPLEX
8563.52/000CF	Panel 24 × SC
8563.53/000CF	Panel 36 × SC
8563.54/000CF	Panel 12 × SC
8505.16/000CF	Panel 24 × SC duplex (1.9 mm)
8505.29/000CF	Panel 24 × ST/FC
8523.40/0000	Splice tray KM 1
8510.12/0000	Lid for KM 1
491481	Splices holder TS6

KM 1 for capacity 24 and splice trays SK 120 for capacity 36

For other variants, please, contact our sales department.

## ORDER CODES ORMPV 2U

Order Code	Name
8563.00/0AZCF	Without connectos panel
8505.15/000CF	Panel 72 × E2000
8505.27/000CF	Panel 48 × E2000
8505.28/000CF	Panel 48 × ST/FC
8563.51/000CF	Panel 48 × SC
8563.57/000CF	Panel 72 × SC
8505.56/000CF	Panel 96 × SC
8505.57/000CF	Panel 96 × E2000
8505.84/0000F	Set – 8 × Splice tray SK120, splice holders, cover, hinges

KM 1 for capacity 72 and splice trays SK 120 for capacity 96

For other variants, please, contact our sales department.

## ORDER CODES ORMPV 3U

Order Code	Name
85HU.85/00BKF	Without connectos panel
85hu.95/000CF	Panel 144 × E2000/SC
8563.69/00AC	Panel 72 × LCQ right

Module rackmounted distributor ORMPM 3U/144 is designed for the placement 144 optical connectors into 12 vertical modules indoor. It is to install into 19" rack.

- ▶ Capacity 144 optical connectors
- ▶ Connector holder SC simplex, E2000
- ▶ 12 vertically placed modules
- ▶ Placement of optical fiber reserve
- ▶ Installation into a 19" frame
- ▶ High 3U
- ▶ Possibility of installing the both the front and the rear support rails
- ▶ Possibility of horizontal sliding



YouTube

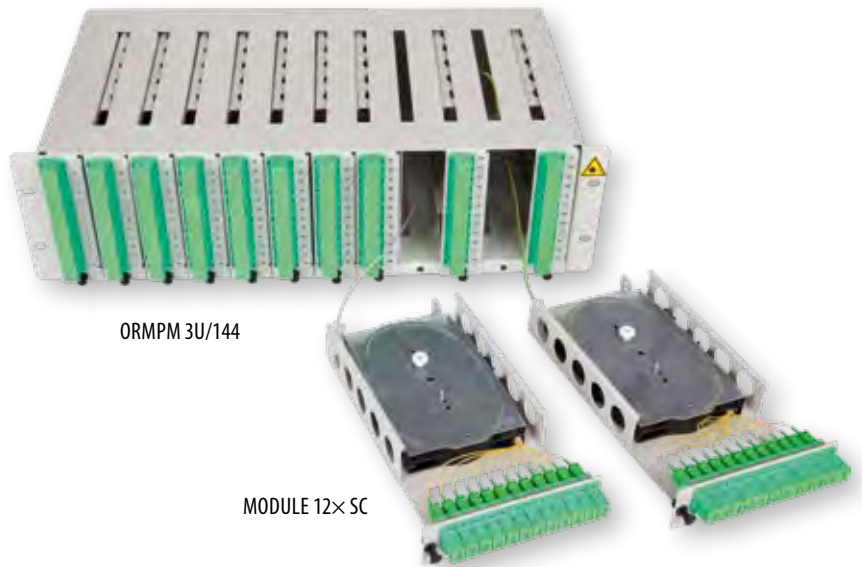

ORMPM 3U/144

MODULE 12x SC

## TECHNICAL SPECIFICATIONS

Colour	Light grey RAL 7035
Material – ORMPM 3U/144	Painted steel
Material – module	Painted aluminium
Dimensions	483 × 130 × 250 mm
Weight – ORMPM 3U/144	3.2 kg
Weight – module	0.2 kg

## RECOMMENDED ACCESSORIES

Splice trays	Kazety na sváry
Splice holders	Držáky svárů
Lid	Víčko

Other accessories on the pages 053, 067–075

Další příslušenství na str. 053, 067–075

## ORDER CODES

Order Code	Name
8562.00/0000F	ORMPM 3U/144
8562.10/SC00F	Module 12 × SC / Modul 12 × SC
8562.43/SC00F	Module 24 × SC / Modul 24 × SC

For other variants, please, contact our sales department.

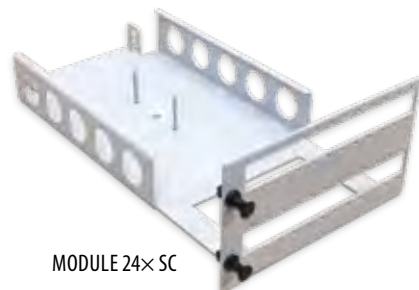

MODULE 24x SC

# ACCESSORIES FOR ORMPM



## ACCESSORIES FOR ORMPM



1



2



3

### ORDER CODES

Order Code	Name	Position
8562.25/0000F	Box for reserves 1U	-
8562.15/0000F	Box for reserves 2U	1
8562.34/0000F	Box for reserves – rear entry without rings	2
8562.80/0000F	Box for reserves – rear entry with cable rings	3

For other variants, please, contact our sales department.

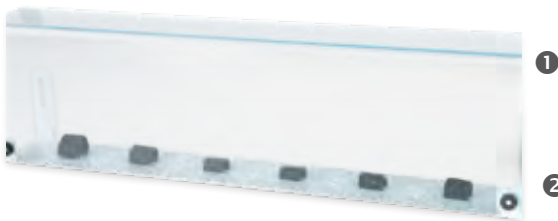

1

2



3



4

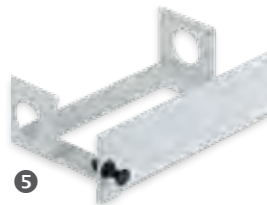

5



6

### ORDER CODES

Order Code	Name	Position
8562.18/PLEXF	Plexi for ranging panel	1
8562.18/PAN0F	Ranging panel	2
8562.18/0000F	Ranging panel with plexi	1+2
8562.11/0000F	Cable lead panel ORMPM 3U	3
8562.38/000CF	Blinding panel	4
8562.39/000CF	Blinding modul	5
491582	Corrugated tube 4.8 × 7.1 mm	6

For other variants, please, contact our sales department.

# ORSM 1 ORSM 2

## HIGH DENSITY OPTICAL DISTRIBUTION CABINET WITH COMPACT CONNECTOR MODULES

GPON READY 5G READY ORSM

High density cabinet of a simple concept based on compact modules accommodating connectors, adapters and pigtails. Modules are located in the column in the middle part of the rack. In the right part of the rack there is sufficient space for optical fibre cables termination. Left part is dedicated to comprehensive patchcord management allowing smooth routing of requested fibre connections. Can be used mainly in distribution points of FTTH point to point or PON networks, data centers, SAN networks, for mobile backhaul optical fibre termination and finally in backbone and transmission networks of telco operators.

- ▶ Capacity of 72 modules ( 864 SC connectors)
- ▶ ORSM2 capacity up to 1728 LC
- ▶ Standard rack dimensions 2200 × 600 /900 × 300 mm
- ▶ Easy manipulation and comprehensive arrangement of terminated optical cables
- ▶ Modular design allowing to split investment in time according to demand
- ▶ Supports back to back or side by side installation including sufficient raceways for patchcord routing between racks
- ▶ Compact modules accommodating connectors adapters, pigtails and fibre splices including the overlength storage of microcable (3 m), indoor optical cable up to 4 mm outside diameter or optical cable buffer
- ▶ Manipulation with the compact module does not impact any other optical fibre in neighbouring modules
- ▶ Compact modules support pre-terminated cables
- ▶ Compact modules support accommodation of ribbon splices and ribbon fan-outs

YouTube



CABLE SPLITTER



ORSM 1



ORSM 2

### TECHNICAL SPECIFICATIONS

Colour	Light grey RAL 7035
Material – distribution box	Painted steel
Dimensions	2200 × 600/900 × 300 mm
Weight	66 kg / 150 kg (without modules)

### RECOMMENDED ACCESSORIES

Other accessories on the pages 069, 074

# ACCESSORIES FOR ORSM

GPON READY 5G READY ORSM

## OPTIONAL ACCESSORIES

- ▶ Lockable double glass door with three-point lock
- ▶ Fixing material for fibre optic cable terminations
- ▶ Compact modules equipped with 12 connectors and pigtails SC/APC including splice holder for heat-shrink fusion splice protective sleeves
- ▶ Compact modules equipped with 12 connectors and pigtails SC/UPC including splice holder for heat-shrink fusion splice protective sleeves
- ▶ Compact modules equipped with 24 connectors and pigtails LC/APC including splice holder for heat-shrink fusion splice protective sleeves
- ▶ Compact modules equipped with 24 connectors and pigtails LC/UPC including splice holder for heat-shrink fusion splice protective sleeves
- ▶ Heat-shrink fusion splice protective sleeves
- ▶ Cable/duct splitter 24 × 5 mm
- ▶ Mechanical fibre optic splice
- ▶ Optional protective duct 12× SC = 1× Ø 5 mm, 24× LC = 2× Ø 4 mm

Other options of the compact module assembly can be supplied upon request (E2000 connectors, applications with pre-terminated optical cables, ribbon fan-outs, splitters)

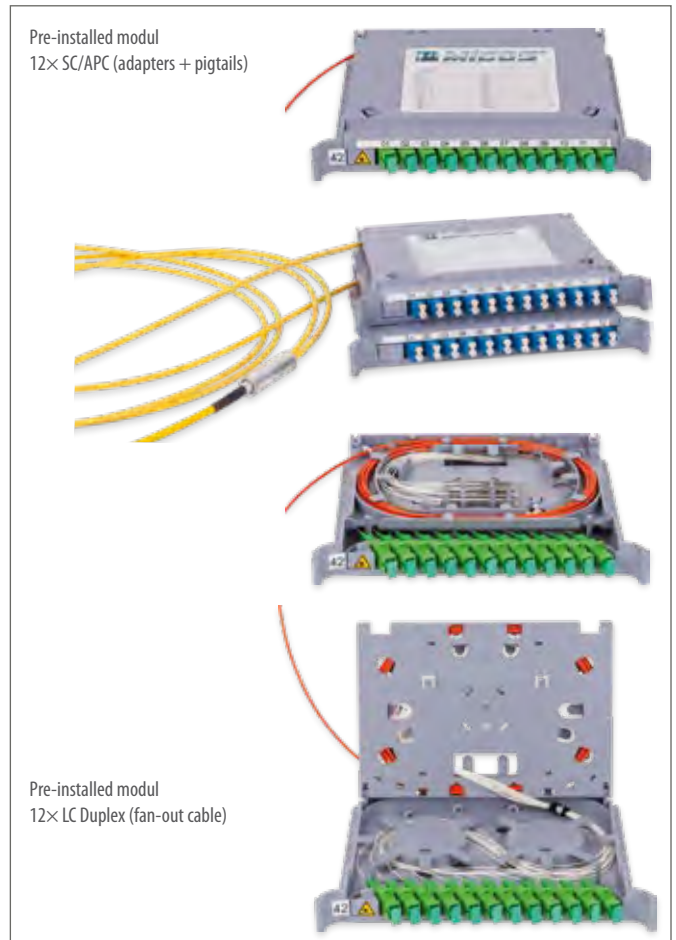
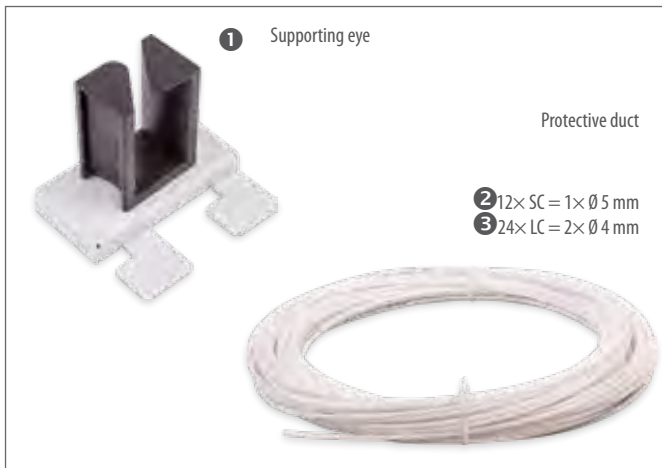

### ORDER CODES

Order Code	Name	Position
85T2.14/0000F	Supporting eye	1
8506.17/0000F (30 m)	Protective duct 12× SC = 1× Ø 5 mm	2
85BV.09/0000F (50 m)	Protective duct 24× LC = 2× Ø 4 mm	3
85T2.11/0000	Partition from management reel	4
852X.60/0000F	Cable/duct splitter 1/24	5
85EK.00/0000F	ORSM 1 left	
85EK.50/0000F	ORSM 1 right	
852X.10/0000F	ORSM 2 left	
852X.70/0000F	ORSM 2 right	
852X.24/SESTF	Two-piece door ORSM 2 L	
852X.73/SESTF	Two-piece door ORSM 2 P	
85T2.24/SESTF	Two-piece door ORSM 1, 3 L	
85T2.94/SESTF	Two-piece door ORSM 1, 3 P	

For other variants, please, contact our sales department.



# ORS 1/300 / ORS 1/600 ORS 2/300 / ORS 2/600

HIGH DENSITY CABINET

5G READY

The ORS 1/300/600 and the ORS 2/300/600 optical distribution cabinets are designed for the placement of 1920 and 960 optical connectors indoors in a CENTRAL OFFICE. The distribution boxes allow to terminate and lead out any type of optical cables to main optical node.

- ▶ Capacity of the ORS 1 is 1920 optical connectors
- ▶ Capacity of the ORS 2 is 960 optical connectors
- ▶ For ORS 1, two separate sections, 20 modules each
- ▶ For ORS 2, one section, 20 modules
- ▶ Module construction (48 optical connectors)
- ▶ Module for placement of splice trays/patchcord reserves
- ▶ Easy access – double rotating system (frame/module)
- ▶ Connector pannel E2000, SC simplex, LC duplex
- ▶ Placement up to 5 m for ORS 1 and 8 m for ORS 2 of optical fiber
- ▶ For ORS 2, option of left or right handed rack and module
- ▶ Easy and variable management
- ▶ Possibility of installing passive elements into the modules
- ▶ Frame locking in the open position
- ▶ Recommended patchcord diameter 1.8 mm

YouTube



ORS 1/300



ORS 2/600

## TECHNICAL SPECIFICATIONS

Colour	Light grey RAL 7035
Material – distribution box	Painted steel
Dimensions	
– ORS 1/300 / ORS 1/600	2200 × 1200 × 300 mm / 2200 × 1200 × 600 mm
– ORS 2/300 / ORS 2/600	2200 × 830 × 300 mm / 2200 × 830 × 600 mm
Weight (netto)	
– ORS 1/300 / ORS 1/600	195 kg / 215 kg
– ORS 2/300 / ORS 2/600	137 kg / 158 kg
Weight (brutto)	
– ORS 1/300 / ORS 1/600	235 kg / 260 kg
– ORS 2/300 / ORS 2/600	177 kg / 205 kg

## RECOMMENDED ACCESSORIES

- Splice trays
- Splice holders
- Lid

Other accessories on the pages 058, 069–075

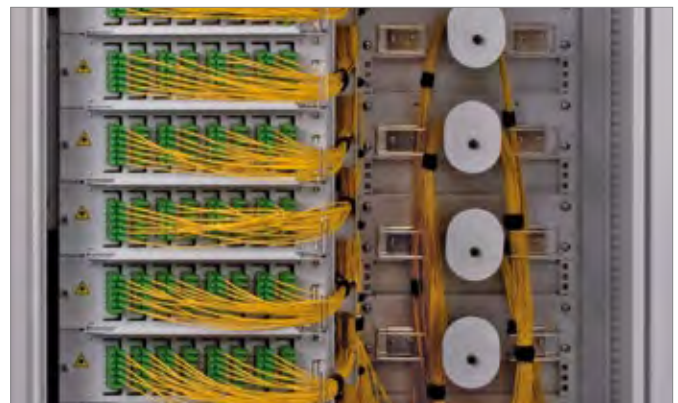



# ACCESSORIES FOR ORS

## MODULES FOR ORS

Hinged ORS modules are designed for the placement of 48/96 optical connectors indoors. The design of the modules enables to install it into high-capacity distribution cabinets ORS with maximum capacity 1920 optical connectors.

- ▶ Capacity of 48/96 optical connectors
- ▶ Connector panel E2000, SC simplex, LC duplex
- ▶ Module for the placement of splice trays or patchcords reserves or breakout cables
- ▶ Modules for ORS cabinet with depth 300 mm and 600 mm
- ▶ Placement of optical fiber reserve, length 5 m



### TECHNICAL SPECIFICATIONS

Colour	Light grey RAL 7035
Material	Painted steel
Weight	Module for reserves: cca 1.7–2.2 kg (by type) Module for splice trays: cca 2–2.9 kg (by type)

### ORDER CODES

For ORS 300	For ORS 600	Name
8573.62/E200F	8542.52/0000F	Module for reserves left, connector panel E2000
8573.63/E200F	8542.53/0000F	Module for reserves right, connector panel E2000
8573.62/SC00F	8542.52/SC00F	Module for reserves left, connector panel SC/LC duplex
8573.63/SC00F	8542.53/SC00F	Module for reserves right, connector panel SC/LC duplex
8573.60/E2BKF	8542.50/E2BKF	Module for splice trays left, connector panel E2000, without splice trays
8573.61/E2BKF	8542.51/E2BKF	Module for splice trays right, connector panel E2000, without splice trays
8573.60/SCBKF	8542.50/SCBKF	Module for splice trays left, connector panel SC/LC duplex, without splice trays
8573.61/SCBKF	8542.51/SCBKF	Module for splice trays right, connector panel SC/LC duplex, without splice trays
8523.41/0000	8523.41/0000	Set of splice trays KM 1 for 48 splices (4× splice tray KM 1, 8× splice holders, cover KM 1)

For other variants, please, contact our sales department.

## ACCESSORIES FOR 1, 2/600



### ORDER CODES

Order Code	Name	Position
8542.56/0000F	Blinding panel ORS 1, ORS 2	–
8542.58/0000F	Cable holder ORS up to 12 mm	1
8542.95/1100F	Cable holder ORS up to 18 mm	–
8542.10/1100F	Cable holder ORS 2 up to 8 mm	2
8542.94/1100F	Cable holder ORS 2 up to 13 mm	–
8542.59/0000F	Cable holder to 20 mm	–

For other variants, please, contact our sales department.

### ORDER CODES

Order Code	Name	Position
8542.29/1101F	Cables base ORS 1, ORS 2	1
8546.36/0001F	Panel for ducts and cables	–
490978	Plastic duct 25 × 40 mm	–
8558.17/00B1F	Floor plate cover ORS 1, ORS 2	–
8542.77/2200F	Connection enclose ORS 1, ORS 2	–
490360	Strap SCOTCHFLEX 20 mm × 10 m	–
8542.14/0001F	Base for cable holders ORS 1, ORS 2	–

For other variants, please, contact our sales department.

NEW

5G READY

High-capacity stand distribution cabinet is designed for the installation of 19" technology indoors. There is space for the placement of the optical interconnected patchcords reserve on the right side. The distribution cabinet is designed for the assembly of 19" optical distribution panels and for the installation of active components only on rear 19" rails.

- ▶ Height 44U
- ▶ Easy module system
- ▶ Cable inputs from bottom or from top
- ▶ Easy access to cables and fibers
- ▶ Option to terminate all the types of cables and micro ducts
- ▶ Horizontal and vertical organization of patchcords
- ▶ Easy assembly
- ▶ Possibility of right or left version



CABLE HOLDER

ADJUSTABLE FEET

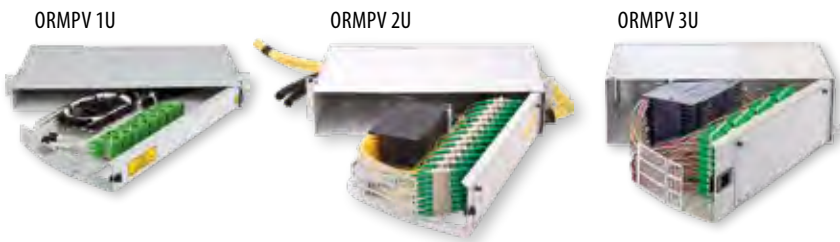

ORMPV 1U

ORMPV 2U

ORMPV 3U

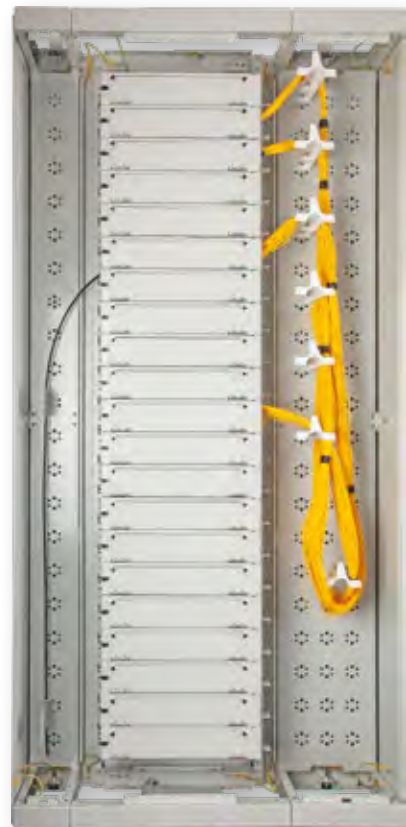

WITHOUT DOOR

## TECHNICAL SPECIFICATIONS

Colour	Light grey RAL 7035
Material – distribution box	Painted aluzinc
Dimensions	2200 × 1050 (150 + 600 + 300) × 300 mm
Weight (brutto)	90 Kg

## RECOMMENDED ACCESSORIES

Door	
Lock	
Hinged ODF ORMPV 1U/2U for ORSL EE	
Splice trays	
Splice holders	
Lid	
Other accessories on the pages 058, 069–075	

# ORSL AP 300 ORSL AP 600

HIGH DENSITY CABINET

GPON READY

5G READY

High-capacity stand distribution cabinet is designed for the installation of 19" technology outdoors. There is prepare the space for the placement of the optical interconnected patchcords reserve on the right. Distribution cabinet is designed for the assembly of 19" optical distribution boxes and for the installation of active components.

- ▶ Height 42U
- ▶ Easy module system
- ▶ Cable inputs from bottom or from top
- ▶ Easy access to cables and fibers
- ▶ Option to terminate all the types of cables and micro ducts
- ▶ Horizontal and vertical organization of patchcords
- ▶ Easy assembly
- ▶ Extensive accessories
- ▶ Optional final finish
- ▶ Possibility of right or left version

ORSL AP 300



ILLUSTRATIVE PHOTO

ORMPV 1U



ORMPV 2U



ORMPV 3U



ORSL AP 600



## TECHNICAL SPECIFICATIONS

Colour	Light grey RAL 7035
Bushings	Brushed inlets
Material	Painted steel
Dimensions	2165 × 900 × 300 mm / 2000 × 900 × 600 mm
Weight (netto)	15 kg / 25 kg
Weight (brutto)	65 kg / 75 kg

## RECOMMENDED ACCESSORIES

Hinged ODF ORMPV 1U/2U

Splice trays

Splice holders

Lid

Other accessories on the pages 051, 069–075

GPON READY

5G READY

The wall-mounted optical distribution cabinet MNORS is designed for the placement of 480/672 optical connectors indoor and outdoor.

- ▶ Capacity of 480/672 optical connectors
- ▶ High 10U and 14U
- ▶ Possibility to install 19" hinged special version of ODF ORMPV (installation on the rear rails)
- ▶ Easy access to cables and fibers
- ▶ E2000 or SC simplex connector panel
- ▶ Easy module system
- ▶ Easy manipulation with connecting patchcords
- ▶ 2× one-point lock
- ▶ It enables to install active components
- ▶ Cable inputs/outputs from bottom or from top
- ▶ Recommended patchcord diameter 1.8 mm



ORMPV 1U



ORMPV 2U



ORMPV 3U

### TECHNICAL SPECIFICATIONS

Bushings	24× PG13.5 (8–12 mm)
Coverage degree	IP 20 or 54 to EN 60529
Colour	Light grey RAL 7035
Dimensions	10U – 730 × 700 × 370 mm
	14U – 930 × 700 × 370 mm
Weight	35 kg / 40 kg

### RECOMMENDED ACCESSORIES

Hinged ODF ORMPV 1U/2U
Splice trays
Splice holders
Lid
Other accessories on the pages 051, 069–075

# rDSLAM 450M rDSLAM 900D

REMOTE DSLAM

Remote DSLAM is designed for complete reinstallation of the network node in a metallic network and installing DSLAM devices. Cabinet contains metallic elements and extra space for splitters field. It allows voice services. Required outage during installation of the cabinet is about 8 hours. Scenarios for remote DSLAM devices are always necessary to modify for your network, please contact our sales department.

- ▶ Possibility to remote power feed (20/30 pairs) or set up a new power supply
- ▶ Technology for metallic cables HD 180 (typically up to 450/900 pairs)
- ▶ Splitters field SID-C (96/192 voice services)
- ▶ Underground base for installation in trench or through a template on concrete
- ▶ Cable transit sealing with cement Compound 16 A
- ▶ Cooling fan for the power dissipation of up to 400 W
- ▶ 19" technology for DSLAM and other devices – 4U/5U (max. depth 255mm)
- ▶ DIN rail for electrical devices – 14/18 positions
- ▶ Holder for 6× SC (incoming fiber optic cable is spliced in splice box placed in the base of the cabinet)
- ▶ Rail for SONAP holders are placed in the base of cabinet
- ▶ Cable clips



rDSLAM 450M



rDSLAM 900D

## TECHNICAL SPECIFICATIONS

Bushings	3× ø50; 4× ø30; 2× PG13.5 (5–12 mm); 1× PG9 (2.5–8 mm)
Cover degree	IP54 to EN 60529
Self-extinguishing	V0 to UL 94
Impact protection degree	IK 10 to EN 50102
Solar radiation (UV)	EN 60068-2-5
Material	PREPREG SMC
Colour	Light grey RAL 7035
DIMENSIONS	1200 × 550 × 350 mm
Weight	39 Kg

## ORDER CODES

Order Code	Name
On request	rDSLAM 450M
On request	rDSLAM 900D
On request	Underground base
On request	Template for installation on concrete

For other variants, please, contact our sales department.

# FIBEROAD SYSTEM

NEW

GPON READY

5G READY

FibeRoad

FibeRoad system is designed for optical fiber networks of all types. For the use in distribution boxes, street cabinets or high capacity cabinet. It allows for all configurations of fiber distribution and patching direct in the stacking system. Ideal for GPON networks.

- ▶ Possibility of cascade solution for saving place
- ▶ Compatible to trays KM 4 (24 splices), KM 5 (12 SC), KM 6 mini (24 splices)
- ▶ Possibility to mix different trays in one box
- ▶ Modular capacity increasing by segments
- ▶ Patching solution in the stacking system
- ▶ Possibility of placing the splitters away from trays
- ▶ Space for the placement of unused fibers
- ▶ Compatible to fibers in secondary sheath (0.9 mm)



## ORDER CODES

Order Code	Name	Position
495529	Management KM P	1
495785	Support stick (2pcs needed)	2
495530	Tray holder KM	3

For other configurations will you please contact our sales department.

# FIBEROAD SYSTEM – TRAYS

## TRAY KM 4



KM 4 3× ribbon + splitter

KM 4 12× 0.9 mm sheat

KM 4 24× 0.25 mm sheat

- ▶ Placement of up to 24 splices
- ▶ Without the need to measure the fibers before splicing
- ▶ Placement the splices away from the fibers
- ▶ Possibility to unwind incoming directions separately
- ▶ Possibility to place a splitter
- ▶ Possibility of placing fibers in 0.9 mm sheath (pigtail)
- ▶ Possibility of ribbon fibers
- ▶ Hingeable and stackable on mandrel

### ORDER CODES

Order Code	Name
85AV.04/0000	Tray KM4
85AV.05/0000	Lid for KM4

For other configurations will you please contact our sales department.

## TRAY KM 5



- ▶ Placement of up to 24 splices
- ▶ Placement of 12 SC simplex or 12 LC duplex adapters
- ▶ Place for pigtails and fibers reserves in the lower part
- ▶ Screw-free/Fast system of adapter mounting
- ▶ Patchcords cover
- ▶ Channels for patchcord routing
- ▶ Possibility to place a splitter
- ▶ Possibility of placing fibers in 0.9 mm sheath (pigtail)
- ▶ Possibility of ribbon fibers
- ▶ Hingeable and stackable with help of connecting pieces

### ORDER CODES

Order Code	Name
85AV.94/0000F	Tray KM 5 (set)
495531	Connecting piece KM 5

For other configurations will you please contact our sales department.

## TRAY KM 6

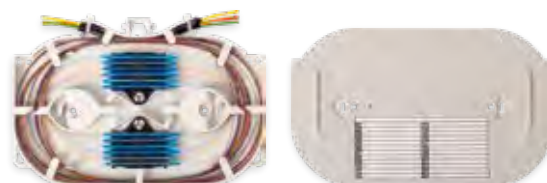

- ▶ Placement of up to 24 splices
- ▶ Compact size
- ▶ Possibility to place a splitter
- ▶ Possibility of placing fibers in 0.9 mm sheath (pigtail)
- ▶ Possibility of ribbon fibers
- ▶ Hingeable and stackable on threaded rod

### ORDER CODES

Order Code	Name
495535	Tray KM6
495536	Lid for KM6

For other configurations will you please contact our sales department.

# ORSM SYSTEM

## ORSM

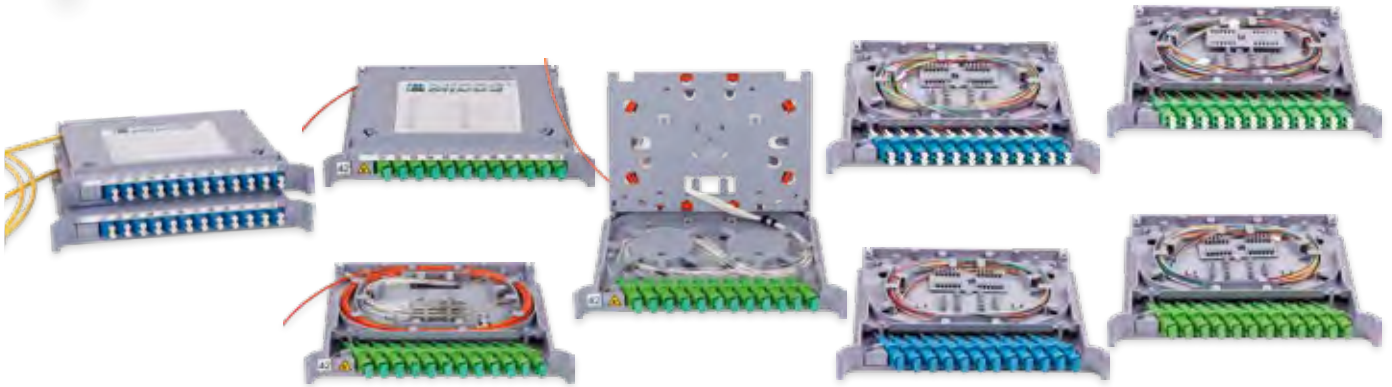

### ORDER CODES

Order Code	Name
85T2.48/0000F	ORSM module – complete unequipped module
85T2.48/0SALF	ORSM module 12×SC/APC for the left ORSM (with adapters)
85T2.48/0SULF	ORSM module 12×SC/UPC for the left ORSM (with adapters)
85T2.48/0LALF	ORSM module 24×LC/APC for the left ORSM (with adapters)
85T2.48/0LULF	ORSM module 24×LC/UPC for the left ORSM (with adapters)
85T2.48/PSALF	ORSM module 12× SC/APC for the left ORSM (with adapters and pigtails)
85T2.48/PSULF	ORSM module 12×SC/UPC for the left ORSM (with adapters and pigtails)
85T2.48/PLALF	ORSM module 24×LC/APC for the left ORSM (with adapters and pigtails)
85T2.48/PLULF	ORSM module 24×LC/UPC for the left ORSM (with adapters and pigtails)
85T2.48/POCEF	ORSM splicing module
852X.90/000XF	ORSM assembly module

For other variants, please, contact our sales department.

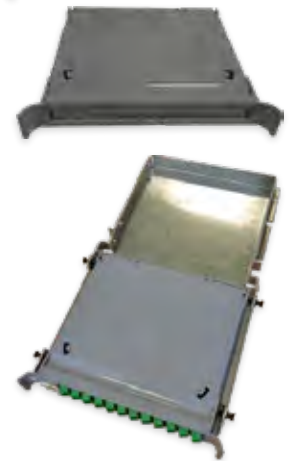

# SAFeTNET SYSTEM

## SAFeTNET



1



2



3

### ORDER CODES

Order Code	Name	Position
490376	Subscriber unit kit	1
490375	Element unit kit	2
8506.59/0000F	SS splice trays module	3
8510.21/0000	SE, SC module lid	-

For other variants, please, contact our sales department.



# UNIVERSAL ACCESSORIES

## SPLICE TRAY KM 1

- ▶ Placement of 12 splices
- ▶ Material – plastic
- ▶ The possibility of a packet assembly
- ▶ Dimensions – 152 × 102 × 8 mm
- ▶ Recommended for distributor range ORM, ORMP, ORMPV, ORS, SNM, ORMPTR, SOP, POR, ORMPM

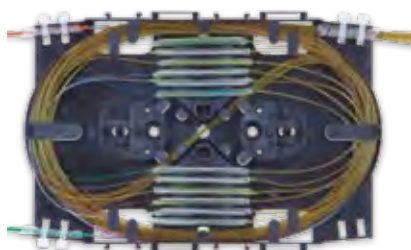

1



### ORDER CODES

Order Code	Name	Position
8523.40/0000	KM 1 – black	1
8510.12/0000	Lid for splice tray KM 1 – transparent	2
8523.40/B000	KM 1 – white	

For other variants, please, contact our sales department.

## SPLICE TRAY KM 2

- ▶ Placement of 8 splices
- ▶ Material – plastic
- ▶ Dimensions – 116 × 87 × 10 mm
- ▶ Recommended for distributor range ORM 4, ORM 8



### ORDER CODES

Order Code	Name
8523.42/0000	KM 2 + lid

For other variants, please, contact our sales department.

## SPLICE TRAY SK123

- ▶ Placement of 12 splices
- ▶ Material – plastic
- ▶ Modular hinged system

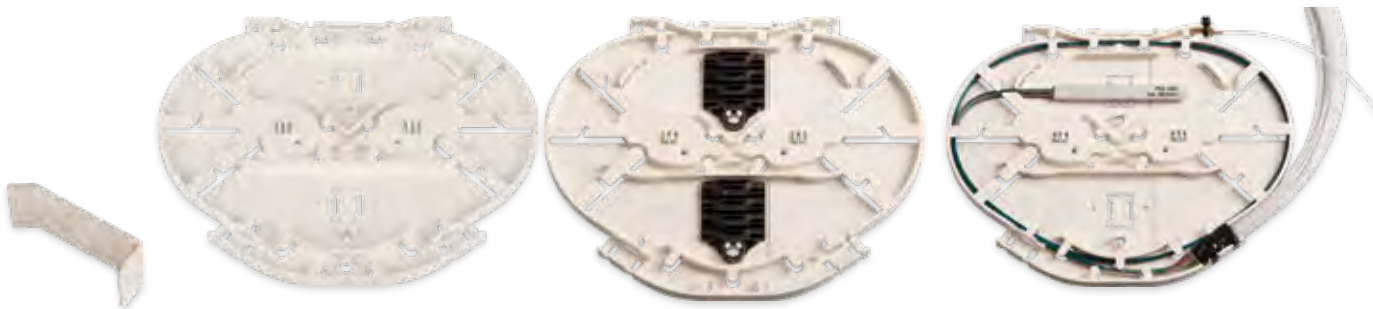

### ORDER CODES

Order Code	Name
85HC.35/0000F	Splice tray SK 123 with splice holder (modular hinged system)
492769	Lid for SK 123
85HC.06/0000	Locking for modular hinged system of splice tray

For other variants, please, contact our sales department.

## SPLICE TRAY EC2

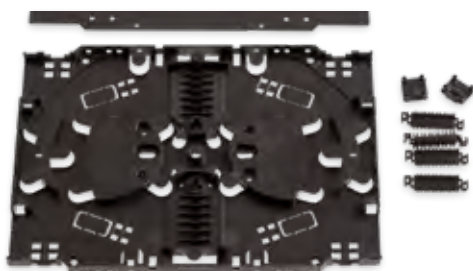

- ▶ Placement of 24 splices
- ▶ Material – plastic
- ▶ The possibility of a packet assembly
- ▶ Dimensions – 171.5 × 110 × 8 mm

### ORDER CODES

Order Code	Name
491711	Splice tray EC2
491712	Lid for splice tray EC2
492001	Splice comb for pigtails for splice tray EC2
491713	Hinge for splice tray EC2

For other variants, please, contact our sales department.

## SPLICE TRAY SK121/S



- ▶ Placement of 24 splices
- ▶ Material – plastic
- ▶ The possibility of a packet assembly
- ▶ Dimensions – 180 × 130 × 8 mm

### ORDER CODES

Order Code	Name
490262	SK 121/S (Included the plastic hinges)
850D.11/0000	Lid for SK 121/S

For other variants, please, contact our sales department.

## SPLICE HOLDERS AND HEATSHRINKS

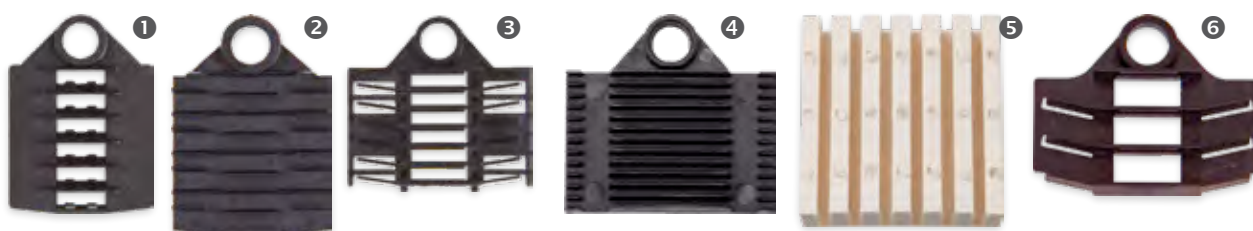

### ORDER CODES

Order Code	Name	Name	Position
491481	TS 6	6 position splice holder (heatshrink)	1
491303	TS 8	8 position splice holder (heatshrink)	2
85M9.16/0000	TS 12	12 position splice holder (heatshrink)	3
85M9.17/0000	K 12	12 position splice holder Crimp	4
8541.35/BALOF	CTS 12 – 37.5 × 40 × 8 mm	Rubber 12 position splice holder (heatshrink)	5
495241	RIB 3	3 position splice holder Ribbon or splitter 4 × 4 mm	6

For other variants, please, contact our sales department.

### ORDER CODES

Order Code	Name	Description
493519	Heatshrink L=40mm D=2.4mm	Compatible with TS 12
493520	Heatshrink L=45mm D=2.4mm	Compatible with TS 12
493522	Heatshrink L=40mm D=2.6mm	Compatible with TS 6 and TS 8
493523	Heatshrink L=45mm D=2.6mm	Compatible with TS 6 and TS 8
493524	Heatshrink L=60mm D=2.6mm	Compatible with TS 6 and TS 8

For other variants, please, contact our sales department.

## PARKING ELEMENT



- ▶ Save placement of unused connectors
- ▶ Capacity 16 × SC
- ▶ Dimensions 54 × 67 × 20 mm
- ▶ Material: low-porous rubber T130 – selfadhesive

### ORDER CODES

Order Code	Name
85BV.04/0000F	Parking element

For other variants, please, contact our sales department.



## BUSHINGS



### ORDER CODES

Order Code	Name	Position
85BV.25/0000F	PG 7	1
391900	PG 9	2
301000	PG 13.5	3
301100	PG 16	4
341000	PG 29	5

For other variants, please, contact our sales department.



### ORDER CODES

Order Code	Name	Position
85BV.25/0MVLF	PG 7/3×1.6–2.6	1
8580.67/0000F	PG 16/2×3	2
8580.68/0000F	PG 16/4×3	3
8580.66/0000F	PG 16/4×5	4
8560.23/1000F	PG 29/12×3	5
8523.30/0000F	PG 29/24×3	6

For other variants, please, contact our sales department.

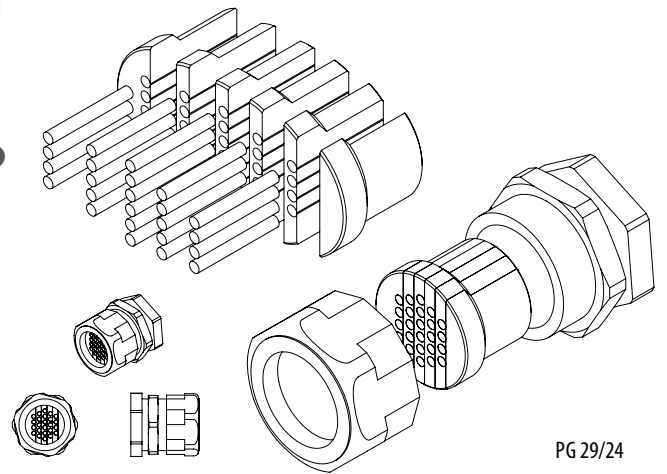

PG 29/24

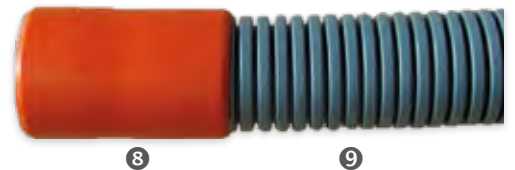

### ORDER CODES

Order Code	Name	Position
8555.03/0000F	Plug 5 × 10 (for HDPE 40/33)	2
8555.02/0000F	Plug 10 × 7 (for HDPE 40/33)	4
8555.09/0000F	Plug 3 × 7 (for HDPE 25/20)	1
8555.07/0000F	Plug 3 × 10 + 5 × 7 (for HDPE 40/33)	3
8555.10/0000F	Plug 5 (10 pcs)	7
8555.05/0000F	Plug 7 (for Plug) (10 pcs)	6
8555.04/0000F	Plug 10 (for Plug) (10 pcs)	5
8555.12/0000F	Bushing ø 50 mm, 6×12 mm	–
475500	Coupling 32/32	–
438800	Coupling 40/40	8
490632	Corrugated tube TXP40	9

For other variants, please, contact our sales department.



**ORDER CODES**

Order Code	Name	Position
85H2.01/BAL0F	Oval bushing for undivided cable MICOS	1
85M9.15/0000	Dividable rubber bushing 2× 1–3 mm	2
490837	Oval bushing for undivided cable	3
490847	Assembly set	4

For other variants, please, contact our sales department.

**EXPRESS PORT**

Express port for mid-span access allow optical cable installation into a box/cabinet as a loop and its use for only needed fibers – the rest pass through the box/cabinet.

- ▶ 1. Express port I. (2× 7–9 mm and 9× 2–5 mm)
- ▶ 2. Express port II. (2× 7–13 mm and 16× 2–5 mm or 8× 11–12 mm)



**ORDER CODES**

Order Code	Name	Position
85K3.07/S000	Express port I.	1
85K3.99/0000	Express port II.	2

For other variants, please, contact our sales department.

**RANGING RINGS AND PROTECTIVE TUBES**



**ORDER CODES**

Order Code	Name	Position
8201.02/0300	Big ring / Oko velké	1
8201.01/0100	Small ring / Oko malé	2
490471	Plastic ring 40 × 80 mm / Plastové oko 40 × 80 mm	3
490550	Plastic ring 40 × 50 mm / Plastové oko 40 × 50 mm	4
490824	Plastic ring 80 × 80 mm / Plastové oko 80 × 80 mm	5
8506.12/0000F	Protective tube / Trubička ochranná 3/2.1 mm, 50 m	6
8506.17/0000F	Protective tube / Trubička ochranná 5/3.5 mm, 30 m	7

For other variants, please, contact our sales department.

## CABLE SPLITTER

- ▶ The cable splitter is used to divide the optical fibres of one cable into six protection tube of  $\varnothing 5/3.5$  mm (No. 1) or  $24 \times 5$  mm,  $24 \times 4$  mm (No. 2)
- ▶ Maximum capacity of 288 fibers in cable
- ▶ Range of cables used  $\varnothing 5.4-20$  mm



### ORDER CODES

Order Code	Name	Position
85H2.05/BAL0F	Cable splitter	1
852X.60/0000F	Cable splitter	2
85FH.00/0000F	Cable splitter 1/8 ( $\varnothing 2.5-8$ mm/ $8 \times \varnothing 3$ mm)	3

For other variants, please, contact our sales department.

## FIXING MATERIAL



### ORDER CODES

Order Code	Name	Position
490360	Strap SCOTCHFLEX 20 mm $\times$ 10 m	1
492790	3M adhesive tape for the fibers fixation in optical splice tray	2
490543	Spiral tape 4 mm	3
490544	Spiral tape 6 mm	3

For other variants, please, contact our sales department.

## TOOLS FOR CONNECTORS

### ORDER CODES

Order Code	Name	Position
491794	Tools for connectors SC simplex	1
492426	Tools for connectors LC	2

For other variants, please, contact our sales department.





## PATCHCORDS AND PIGTAILS



### ORDER CODES

Order Code	Name	Order Code	Name
CN0007	Pigtail SM9/125 SC/UPC G657A SX 0.9 mm, 2 m tight buffer	CN0019	Pigtail set 12× SC/UPC SM9/125 G657A SX 0.9 mm multi color pigtail, 1 m easy strip
CN0008	Pigtail SM9/125 SC/APC G657A SX 0.9 mm, 2 m tight buffer	CN0020	Pigtail set 12× SC/UPC, SM, G657A 0.9 mm LSZH, 2 m (12-multi color set), easy strip
CN0009	Pigtail SM9/125 LC/UPC G657A SX 0.9 mm, 2 m tight buffer	CN0021	Pigtail set 12× SC/APC, SM, G657A 0.9 mm LSZH, 2 m (12-multi color set), easy strip
CN0010	Pigtail SM9/125 LC/APC G657A SX 0.9 mm, 2 m tight buffer		

For other variants, please, contact our sales department.



## OPTICAL ADAPTERS

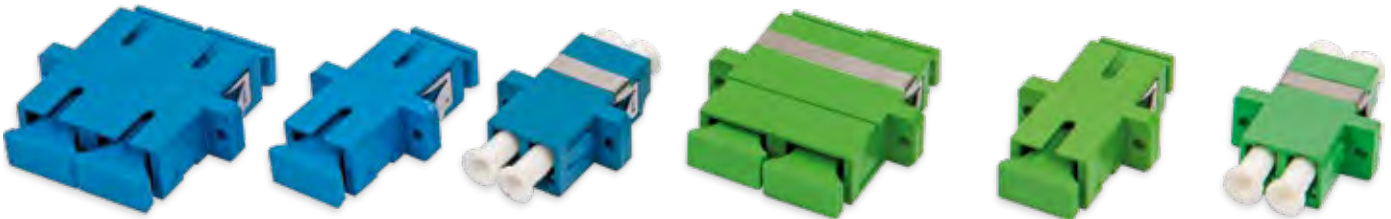

### ORDER CODES

Order Code	Name	Order Code	Name
CN0001	Adapter SC/UPC SM, SX, blue, metal clip	CN0002	Adapter SC/APC SM, SX, green, metal clip
CN0003	Adapter SC/UPC SM, DX, blue, metal clip	CN0004	Adapter SC/APC SM, DX, green, metal clip
CN0005	Adapter LC/UPC SM, DX, blue, with SC footprint, metal clip	CN0006	Adapter LC/APC SM, DX, green with SC footprint, metal clip

For other variants, please, contact our sales department.



## PLANAR LIGHTWAVE CIRCUIT SPLITTER

PLC splitter shall split one or two optical signal into multiple output ports, and features low insertion loss, high uniformity and low polarization dependent loss.

- ▶ Compact design
- ▶ High Reliability
- ▶ Customized packing and configuration
- ▶ Available configuration: 1:2–1:64 and 2:4–2:64

### Availability

- ▶ Bare fiber
- ▶ Fan-out
- ▶ 900 μm
- ▶ Pre-installed in splice tray
- ▶ Pre-installed in ODF or ODB

### TECHNICAL SPECIFICATIONS

Low insertion loss and low PDL  
 Wide wavelength (1260 nm–1650 nm)  
 Operation temperature (-40 °C to +85 °C)  
 Fulfill Teclordia GR-1209-CORE and GR-11221-CORE



### ORDER CODES

Order Code	Name
<b>On request</b>	

For other variants, please, contact our sales department.



## ACCESSORIES FOR ORU, ORU SIS



### ORDER CODES

Order Code	Name	Position
8506.34/0000F	Microtubes holder 24 × 3 mm + 3 × 5 mm	
8506.35/0000F	Microtubes holder 36 × 3 mm + 3 × 10 mm	
8506.31/0000F	Microtubes holder 24 × 5 mm + 3 × 10 mm	1
8506.32/0000F	Microtubes holder 10 × 7 mm	
8506.33/0000F	Microtubes holder 9 × 10 mm	
8506.14/0000F	Holder of tension element – 3 pcs.	2
8507.52/0000F	Holder of thick-walled microducts	3
8299.12/0100	Fastening belt holder	4

For other variants, please, contact our sales department. .



### ORDER CODES

Order Code	Name	Pozice
8555.15//0000F	Bushing ø 50 mm, 7 × 10 mm	1
8555.12/0000F	Bushing ø 50 mm, 7 × 12 mm	2
8555.16/0000F	Bushing ø 50 mm, 7 × 14 mm	3
8506.41/0000F	Rings holder + rings for ORU 2	4
8506.46/0000F	Rings holder + rings for ORU 3	5

For other variants, please, contact our sales department.





#### ORDER CODES

Order Code	Name	Position
8507.42/0000F	Measuring panel 6× SC ORU	1
8508.31/0000F	Panel ORU 18 × SC	2

For other variants, please, contact our sales department.



#### ORDER CODES

Order Code	Name	Pozice
490360	Strap SCOTCHFLEX 20 mm × 10 m	–
8506.42/0000F	Tightening strap – 15 pcs.	–
8506.38/0000F	Tightening strap – 100 pcs.	–
8506.39/0000F	Holder of splice tray modules for ORU 2	1
8506.47/0000F	Holder of splice tray modules for ORU 3	2
8508.38/0100F	Assembly stand for ORU	3
85BV.03/0000F	Resin pack 50 ml + adapter kit	4+5
493615UP	Putty COMPOUND 16A, 500g	6

For other variants, please, contact our sales department.

### ACCESSORIES FOR ORU SIS



#### ORDER CODES

Order Code	Name	Position
490985	Cable holders 8–12 mm	2
490986	Cable holders 12–16 mm	–
087500	Cable holders 16–22 mm	–
103300	Cable holders 22–28 mm	–
087600	Cable holders 28–34 mm	–
073300	Cable holders 34–40 mm	–
490993	Cable holders 28–34 mm	1
490994	Cable holders 34–40 mm	–

For other variants, please, contact our sales department.





## ACCESSORIES FOR ORM 1

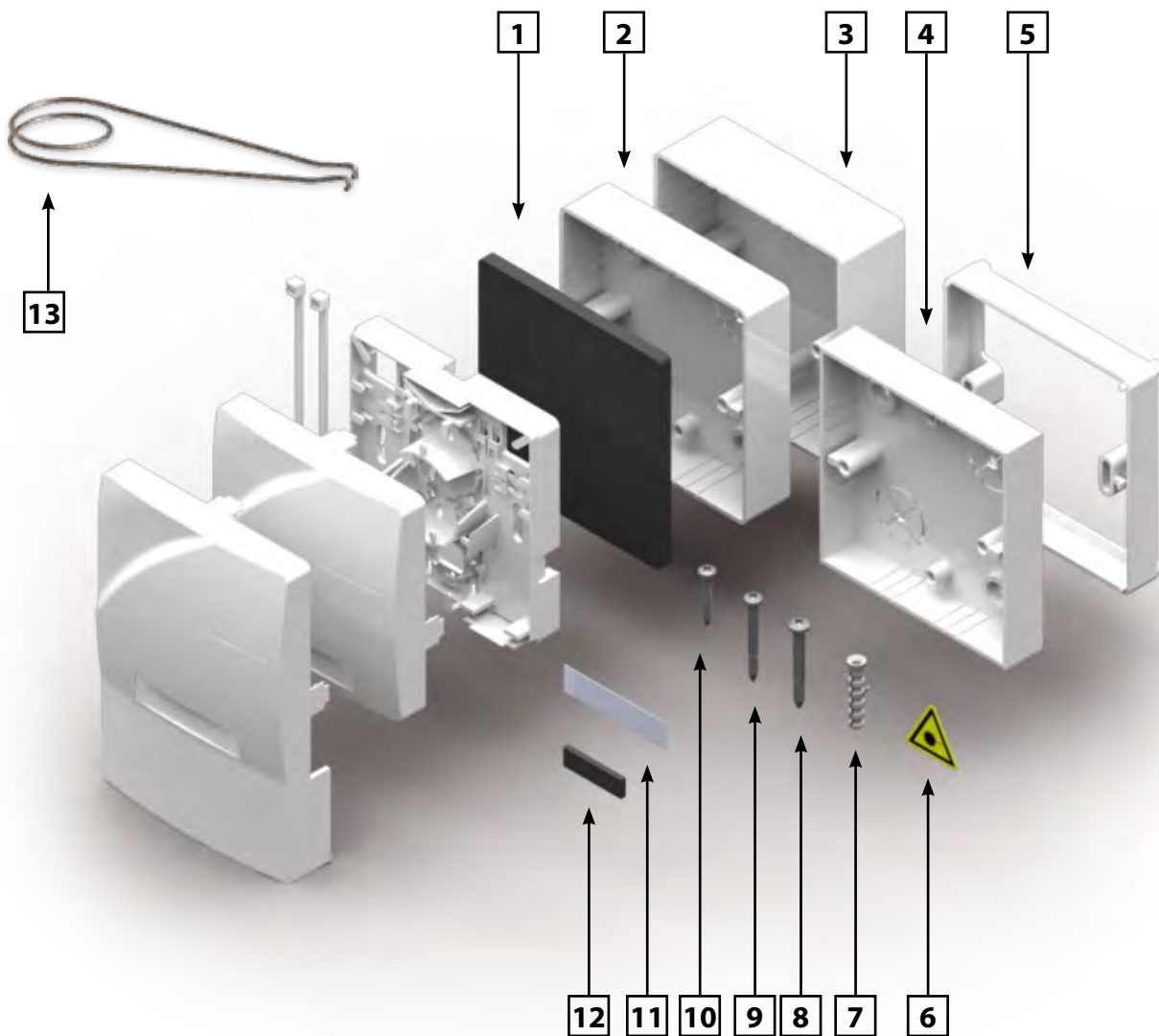

### ORDER CODES

Order Code	Name	Position
491797	Sealing ORM 1 (IP 54)	1
491818	Box for placement of reserves 80 × 80 × 19 mm	2
491819	Box for placement of reserves 80 × 80 × 28 mm	3
491817	Box for placement of reserves 80 × 80 × 16 mm	4
491820	Spacer frame 80 × 80 × 12 mm	5
491870	Sticker Attention Laser Radiation	6
491075	Wall plug (min. 2 pieces needed)	7
491692	Screw for wall plug (min. 2 pieces needed)	8
491692	Screw for frame fixation (min. 2 pieces needed)	9
067600	Screw for fixation of installation box (min. 2 pieces needed)	10
491802	White sticker for description	11
491816	Rubber sealing for splice fixation when 4 pcs splices are applied	12
492004	Opening tool for ORM 1	13

For other variants, please, contact our sales department.



## PREVIOUS GENERATION OF MICOS BOXES

### ORM 24 | WALL-MOUNTED OPTICAL DISTRIBUTION BOX

The ORM 24 optical distribution box is designed for the placement of up to 24 optical connectors for indoors and outdoors. The distribution box may be complemented by a simple bracket, which enables it to be post mounted

- Capacity of max 24 optical connectors
- Connector's capacity 12-24× SC/E2000, optionally 24× LC, 12× ST, FC
- Cable clips
- Adaptor plate 24× SC simplex
- Lockable lid
- Securing of the incoming part (operator's side)- optional
- Wall mounted, post mounted
- Bushings 2× PG 13.5; 1× PG29 patchcord – 24 holes 2-3mm



ORM 24

Dimensions 319 × 205 × 118 mm

### ORM 24 VS | WALL-MOUNTED OPTICAL DISTRIBUTION BOX

The ORM 24 VS optical distribution box is designed for the placement of 24 optical connectors both for indoors and outdoors. The distribution box may be complemented by a simple bracket, which enables it to be post-mounted.

- Capacity 24 optical connectors
- Connector holder SC simplex or E2000, LC
- Modular hinged system
- Usage of SE splice trays for up to 12 fibers
- Optional connector panel
- Coverage degree IP 54
- Extensive accessories



Dimensions 319 × 205 × 118 mm

### ORM 12 (24) SIS, ORM 24 VS SIS | PILLAR OPTICAL DISTRIBUTION BOX

The optical distribution box ORM 12 (24) SIS/24 VS SIS is designed to protect saved, terminated, splitted and interconnected optical fibers, connectors and cables in optical FTx networks. It provides excellent protection against various environmental conditions and simultaneously mechanical protection of the saved fibers. Pillar can be mounted outdoors in an open space in trench.

- Capacity of 12 (24) optical connectors
- Connector holder SC simplex, SC duplex, ST, FC, E2000, LC, LC duplex
- Modular hinged system (ORM 24 VS SIS)
- Usage of SE splice trays for up to 12 fibers (ORM 24 VS SIS)
- Optional connector panel
- Coverage degree IP 54
- Extensive accessories



Dimensions 1747 × 290 × 209 mm

ORM 12 (24) SIS ORM 24 VS SIS

### ORU 1 MUC | OPTICAL DISTRIBUTION BOX IN THE UNDERGROUND CHAMBER

ORU 1 MUC enables installation of optical fibers in the distributor under the ground level, outdoors, in demanding environment as historical town centres, on sites where it is not possible to use the pillar version, near ways etc. Max. load is 3 tons. The assemble stands a short-lasting flooding and is intended for installation in areas used by pedestrians and cyclists. The built-in ORU 1 distributor is designed as multi-purpose with with hinged rack for mounting up to 4 pieces of SAFeTNET modules for termination or interconnection of optical fibers blown in microducts or HDPE tubes.

Dimensions 746 × 1030 × 594 mm



## SOP 36 VS | OPTICAL DISTRIBUTION BOX

Optical box SOP 36 VS is designed for distribution of optical network in buildings by usage of optical cables or microduct system, for protection of optical connections and for interconnection of optical cables. It is wall-mounting in indoor climate with the option of entering / exiting the cable / fiber elements from either side. The box could be placed as necessary in respective etages where the needed number of optical fibers from backbone path is terminated.

- Maximum capacity is 36 optical splices
- Integrated fibre management 6x KM 3 splice tray for the placement of optical splices
- Fixation of input/output cables
- Use for fibers G.657 a,b
- Lockable door
- Break-out side plate from each side
- Wall-mounted
- Easy assembly
- Placement of optical fiber reserve, length 4 m
- The reel for cable reserves



Dimensions 296 × 206 × 108 mm

## ORU 6 MRS | TERMINAL PILLAR DISTRIBUTION BOX

The optical distribution box ORU 6 MRS is designed as pillar customer distributor for termination of one buffer (12 fibers) of a central optical suspension cable. Other fibers pass through distributor by the help of so-called OMEGA without an interruption. The suspension central cable enters from above. The distributor is ready for central cable enter from below by the help of HDPE tubes (Ø 40 mm max.) or microducts and connection of subscribers from below as well. By the help of the special bushings is possible to connect up to 12 subscribers from below by 2 fibers suspension drop cables with or without connectors. It is possible to install 1 piece of SC modul and 12 pieces of SC adaptors into the distributor.



Dimensions 372 × 303 × 152 mm

## POR 12 | FLOOR DISTRIBUTION BOX

Optical box POR 12 is designed for distribution of optical network in buildings by usage of optical cables or microduct system, for protection of optical connections and for interconnection of optical cables. It enables to install two standard splice trays for connection of optical fibers. The box could be placed as necessary in respective etages where the needed number of optical fibers from backbone path is terminated. It is wall mounting in indoor climate. Optical distribution box is designed for the placement of 12 optical connectors.



## ORMPTR 1.5U/2U | DRAW-OUT-TYPE ODF

The ORMPTR draw-out-type patch panel is designed for the placement of 24/48 optical connectors indoors. The design of the distribution box enables to install it into a 19" base. The distribution box is designed for installation cables and micro ducts.

- ▶ Capacity of 24/48 optical connectors
- ▶ Replaceable connector panel SC simplex, SC duplex, ST, FC, E2000, LC
- ▶ Placement of optical fiber reserve
- ▶ Easy assembly
- ▶ Installation into a 19" base
- ▶ Height of 1.5U/2U



ORMPTR 1.5U



ORMPTR 2U

## ORM SNP 4U | DRAW-OUT-TYPE ODF

The ORM SNP 4U draw-out-type ODF is designed for the placement of 288 optical splices, the cable termination and the transition from the fibers to pigtails indoors and outdoors. The design of the distribution box enables to install it into 19" base.

- Maximum capacity 288 optical splices
- Capacity: transition cable-cable – 24 pcs of splice trays SE – 288 fibers (12F in each splice tray SE)  
transition cable-pigtail – 24 pcs of splice trays SE – 144 fibers (6F in each splice tray SE)
- Height 4U
- Termination of all available types of cables ( loose tube, ribbon)
- Saving the handling reserve in a space of the box
- Holder for fixation of 12 pcs microducts  $\varnothing$  5 mm
- Holder for fixation of 48 pcs microducts  $\varnothing$  3 mm
- Easy access to fibers
- Well-arranged
- Mounting box from the front or the back
- Cable entrance from the side or the back
- Transition to pigtails
- Perfect control of bending
- Outputs for pigtails
- Extensive accessories



Dimensions 176 × 431 × 278 mm

## ORM 32 SDF, ORM 32 SDF SIS | OPTICAL DISTRIBUTION BOX

The optical distribution box ORM 32 SDF is designed for splicing, connectors connection and placing the splitter up to 1:32. Patchcord reserves can be stored in the box. The box is ideal for FTtx application.

- Capacity up to 36 SC connectors
- Capacity up to 36 optical splices or 12 optical splices together with ABS splitter
- Possibility to place PLC splitter in tray or ABS box
- Possibility to place excess reserves into the holder
- Possibility of pillar version or on the pole
- Express port (bushing)
- 16× dividable rubber bushing 2× 1–3 mm for patchcords
- Optical connector holder 16× SC/DX



Dimensions  
319 × 205 × 118 mm / 1747 × 290 × 209 mm

## SOP 12 (24) | FLOOR DISTRIBUTION BOX

Optical box SOP 12 (24) is designed for distribution of optical network in buildings by usage of optical cables or microduct systém, for protection of optical connections and for interconnection of optical cables. It is wall-mounting in indoor climate with the option of entering / exiting the cable / fiber elements from either side. The box could be placed as necessary in respective etages where the needed number of optical fibers from backbone path is terminated.

- Maximum capacity is 36 optical splices
- Fixation of input/output cables
- Use for fibers G.657 a,b
- Lockable door
- Break-out side plate from each side
- Wall-mounted
- Easy assembly
- Placement of optical fiber reserve, length 4 m
- The reel for cable reserves

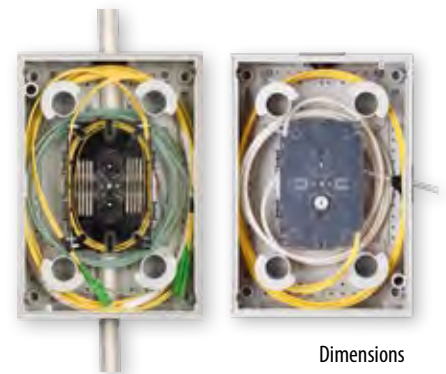

Dimensions  
296 × 206 × 108 mm

## MEDIA BOX | STORAGE BOX FOR ACTIVE COMPONENTS

Storage box for active components MEDIA BOX is designed for mechanical control of a mediaconverter and termination of transmission media – optical fiber at a client.

- Coverage degree IP 10 – vnitřní prostředí (MEDIA BOX)
- Coverage degree IP 54 (MEDIA BOX plastic)



MEDIA BOX PLASTIC

Dimensions  
185 × 103 × 78 mm

MEDIA BOX

Dimensions  
186 × 106 × 47 mm

## HDC 480/864 | STREET CABINET

Outdoor optical street cabinet for 19" technology suitable for installation of hinged ODF ORMPV 1U and 2U.

- Capacity of 480/864 optical splices
- SC simplex connector panel
- Section for cable/patchcord reserves
- Lockable door (5 point lock)
- Lockable front cover (access for cables)
- Height above ground 1500 mm
- Anchoring basement
- Underground plastic base
- High 14U/20U



Dimensions 1685 × 1110 × 320 mm / 1951 × 1110 × 320 mm  
Dimensions – stand 935 × 1110 × 308 mm

## ORM 48/72/96 VSR, ORM 48/72/96 VSR SIS | OPTICAL DISTRIBUTION BOX

The ORM 48/72/96 VSR, 48/72/96 VSR SIS optical distribution box is designed for the placement of 96 optical connectors both indoors and outdoors. The distribution box could be installed outdoors or indoors on a wall, in an open area in trench or could be post-mounted using a special holder.

- Capacity of 480/864 optical splices
- Capacity of 48, 72, 96 optical connectors
- Adapter panel 48, 72, 96 × SC/E2000
- Modular hinged system
- Splice tray system with SK123 splice trays
- Usage of SE splice trays for up to 12 fibers
- Maximum number of modules 2
- Placement of up to 6 m of an optical fiber reserve
- Cable holders
- PG bushings / Rubber bushings
- Lockable doors
- Convenient placing of fibers in each splice tray
- One-point lock



Dimensions 585 × 420 × 216 mm / 1180 × 420 × 216 mm

## SNM 288 VS, SNM 288 VS SIS | OPTICAL CLOSURE

Optical closure SNM 288 VS / 288 VS SIS is designed for the placement of up to 288 optical splices indoors and outdoors. The distributor could be installed outdoors or indoors on a wall or in an open space in trench. The plastic corpus of pillar is staffed by one SNM 288 VS distributor.

- Maximum capacity is 288 optical splices
- Plastic corpus
- Installation – wall-mounted or separate pillar
- Modular hinged system
- Placement of optical fiber reserve, length 2 m
- Usage of SK123 splice trays for up to 12 fibers
- Cable inputs/outputs from bottom
- Convenient placing of fibers in each splice tray
- oval bushing for undivided cable (express port)
- Hinged version SNM 288 VSR / VSR SIS – for PLC splitters or 360 splices



Dimensions 585 × 420 × 216 mm / 1180 × 420 × 216 mm

### INFORMATION

For further information, please, contact our sales department.

# CUSTOMER SOLUTIONS

Have you not found a product in our catalogue to suit your needs? Do you need to modify a standard product? Do not worry and contact us! We offer modifications of existing products and development of brand new solutions tailored to the customer's needs. Our R&D department is ready to execute drawings according to your technical specifications, or manufacture a real test sample. See below the examples of solutions that we have designed for our customers:

## OUTDOOR WALL BOX



## SPLICE OUTDOOR METAL BOX



## INDOOR WALL BOX



## PATCH PANEL



## SOLUTION FOR PRE-CONNECTORIZED CABLE



# CLEAN ASSEMBLY ROOM |



Adapters and pigtails installation in a clean environment

Company MICOS TELCOM provides professional assembling of optical housings as a complex deliveries to their customers. Thanks to this service our customers gain several advantages and especially certainty in installation quality.

The main benefits of assembling optical distributions components and optical fibers directly in the production:

- ▶ Saving time during installation in the field
- ▶ Cost reduction
- ▶ Elimination of mistakes in comparison with complicated conditions in the field
- ▶ Increased quality for the final customer and user
- ▶ The flexible delivery dates due to high production capacity

The advantages of assembling in the MICOS TELCOM production facilities:

- ▶ 18 workplaces under the “clean room” conditions
- ▶ High cleanliness requirements and efficiency in establishment
- ▶ Final inspection of cleanliness and quality
- ▶ Direct traceability to the logistics and flexible delivery supply of orders
- ▶ Complex solutions for your projects



Introducing pigtails into a optical cassettes



Final inspection of ferule cleanliness and measurement of the connectors

Please contact your sales representative with any questions and details you may have.

DISTRIBUTION BOX	INDOOR USE	OUTDOOR USE	MAX. CAPACITY OF OPTICAL CONNECTORS OR SPLICES	PAGE
<b>▶ INDOOR DATA CABINETS</b>				D 92–D 95
MNS / MBS	●			D 92
MSS	●			D 93
MSS0				D 94
MZS	●			D 95
<b>▶ OUTDOOR DATA CABINETS</b>				D 96–D 98
MSS 22U/55	●	●		D 96
SAP 3	●	●		D 97
SAP 4 1500/2000	●	●		D 98
<b>▶ EMC ATECHNOLOGY AND SPECIAL DATA CABINETS</b>				D 99–D 100
MTS 3	●	●		D 99
BS	●	●		D 100
<b>▶ ACCESSORIES</b>				D 101–D 97
<b>▶ EXAMPLES OF INSTALLATIONS</b>				104–106





▶ The MNS and MBS wall mounted data cabinets are designed for the indoor installation of 19" technology onto a wall. Sliding supporting rails are used to install 19" technology. The MBS data cabinets allow technology to be installed vertically, which makes them ideal for limited spaces.

- ▶ Base dimensions MNS 550 × 570 mm
- ▶ Base dimensions MBS 600 × 215, 600 × 260, 600 × 350 mm
- ▶ Height MNS 4U, 6U, 9U, 12U, 15U a 17U
- ▶ Height MBS 3U, 4U, 6U
- ▶ Vertical placement of the technology
- ▶ Sliding rails for fastening 19" technology
- ▶ Lockable door



## ▶ BASIC VERSION

- 2 pairs of sliding vertical 19" rails 1 pair of vertical 19" rails – MBS)
- Lockable glass door with a closed frame
- Sheet steel lockable front door (MBS)
- One-point lock
- Light grey colour (RAL 7035)
- Cable inlets in the top and in the bottom (MNS – 300 × 65 mm, MBS – 220 × 65 mm)
- Cable inlet in the bottom (rubber bushing ø 50 mm)
- Coverage degree IP 20 to EN 60529

## ▶ RECOMMENDED ACCESSORIES

- Ventilation
- Brush inlets
- Inlet panels
- Racks and mounting subracks
- Blinding panels
- Mechanical and electronic locks
- Supporting panels
- Circuit breaker panel
- Power supply leads

Other accessories on the pages D94–D97



## ▶ ORDER CODES

MNS Order Code MNS	Base dimensions [mm]	Height [mm]	Height [U]	Weight [kg]
8670.00/09A0C1UU-32--	550 × 570	506	9	26
8670.00/12A0C1UU-32--	550 × 570	640	12	31
8670.00/15A0C1UU-32--	550 × 570	773	15	37
8670.00/17A0C1UU-32--	550 × 570	862	17	40
	Base dimensions [mm]	Height [mm]	Height [U]	Weight [kg]
8610.00/0300C4-----	600 × 215	535	3	18
8610.00/0400C4-----	600 × 260	535	4	20
8610.00/0600C4-----	600 × 350	535	6	22

For other variants, please, contact our sales department.

▶ The MSS line stand data cabinets are designed for indoor installation of 19" or 21" technology (dimension of the base 800 × 600 mm and larger). A design of the self-supporting assembled frame enables an easy assembly of the data cabinet at the point of installation. The unique construction of these data cabinets also permits to reduce their weight substantially.

- ▶ Assembled frame
- ▶ Sliding supporting rails
- ▶ Removable side covers
- ▶ Possibility of assembling a set of cabinets
- ▶ Variable base dimensions (up to the depth of 1070 mm)
- ▶ Coverage degree IP 20 to EN 60529
- ▶ Loading capacity data cabinets: 300 kg

## ▶ BASIC VERSION

Assembled frame  
 2 pairs of sliding vertical 19" rails  
 Lockable glass door with a closed frame  
 Three-point lock  
 Lockable side covers  
 Lockable rear cover  
 Cable inlets in the top and in the bottom  
 (300 × 65 mm)  
 Light grey colour RAL 7035  
 Possibility of assembling a set of cabinets  
 Coverage degree IP 20 to EN 60529  
 Delivered as a complete unit or Flat-Pack

## ▶ RECOMMENDED ACCESSORIES

Ventilation  
 Brush inlets  
 Inlet panels  
 Bases  
 Castors  
 Spacer legs  
 Shelves and mounting subracks  
 Blinding panels  
 Mechanical and electronic locks  
 Supporting panels  
 Pull-out light  
 Circuit breaker panel  
 Power supply leads  
 Earthing bridge  
 Other accessories on the pages D94–D97

## ▶ INFORMATION

1U = 44.45 mm

## ▶ ORDER CODES

Order Code	Base dimensions [mm]	Height [U]	Height [mm]	Weight [kg]
8872.00/42A0CFU1-111--	600 × 600	42	2050	87
8872.00/45A0CFU1-111--	600 × 600	45	2185	93
8872.00/47A0CFU1-111--	600 × 600	47	2275	97
8872.00/42B0CFU1-111--	800 × 800	42	2050	130
8872.00/45B0CFU1-111--	800 × 800	45	2185	139
8872.00/47B0CFU1-111--	800 × 800	47	2275	145

For other variants, please, contact our sales department.

## ▶ OTHER BASE DIMENSIONS

600 × 300 | 600 × 400 | 600 × 900

For further information, please, contact our sales department.



▶ The MSSO stand data cabinets are designed for the installation of data and telecommunications technology indoor and are fitted with non-adjustable 21" suspension supporting frames, which are mounted on silentblocks.

Stand data cabinets are constructed of welded frame with non-removable rear and side covers. There are breakable inlets for cables in roof and base. The stands with depth 450 mm are equipped with one 21" supporting frame, cable management brackets are included in rear part and can't be adjustable.

The stands with depth 600 mm having two supporting frames and cable management panels are placed on the side part between front and rear support frame. Cable management panels are vertically adjustable.

Earthing rail is a part of the basic equipment.

In the basic version, the data cabinets are supplied without the front door. The doors can be ordered in different variations with perforations or for installation of air-conditioning unit together with other accessories.



## ▶ ORDER CODES ACCESSORIES

Order Code	Notes
8877.04/5601F	MSSO 50SU L/P door with perforation, filter, three-point lock and hinges
8877.21/5601F	MSSO 50SU L door for air-conditioning 850 W with three-point lock and hinges
8877.21/5602F	MSSO 50SU P door for air-conditioning 850 W with three-point lock and hinges
8877.04/6601F	MSSO 64SU L/P door with perforation, filter, three-point lock and hinges
8877.21/6601F	MSSO 64SU L door for air-conditioning 850 W with three-point lock and hinges
8877.21/6602F	MSSO 64SU P door for air-conditioning 850 W with three-point lock and hinges
8877.04/8601F	MSSO 80SU L/P door with perforation, filter, three-point lock and hinges
8877.21/8601F	MSSO 80SU L door for air-conditioning 850 W with three-point lock and hinges
8877.21/8602F	MSSO 80SU P door for air-conditioning 850 W with three-point lock and hinges
8877.30/0000F	Circuit breaker panel
88R4.00/0005F	Pull-out rack 21"/25U/300, for placement the notebook
8877.18/64B1F	Roof cover MSSO 600 × 450 including installation kit
8877.18/66B1F	Roof cover MSSO 600 × 600 including installation kit

For other variants, please, contact our sales department.

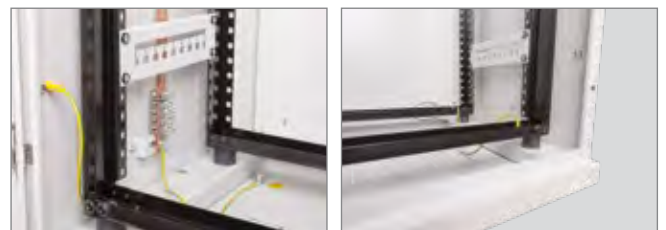

## ▶ ORDER CODES

Order Code	Notes
8877.00/5064F	MSSO 50SU(27U) 600 × 450 1R
8877.00/6464F	MSSO 64SU(36U) 600 × 450 1R
8877.00/6466F	MSSO 64SU(36U) 600 × 600 2R
8877.00/8266F	MSSO 80SU(44U) 600 × 600 2R

For other variants, please, contact our sales department.

▶ Heavy-load data cabinets are designed for the indoor installation of 19" technology intended particularly for data centres. The server cabinet can be connected to another rack to create a data center to increase the required performance server room.

- ▶ Riveted frame
- ▶ Sliding supporting rails
- ▶ Removable side covers or dividing partitions
- ▶ Possibility of assembling a set of cabinets including closed cold aisle
- ▶ Variable base dimensions (up to the depth of 1200 mm)
- ▶ Load up to 1000 kg
- ▶ Door perforation rate up to 82 %



## ▶ BASIC VERSION

- Riveted frame
- 2 pairs of sliding vertical 19" rails
- Load 1000 kg
- Base dimensions 600 × 1000 mm/800 × 1000 mm
- Lockable perforated door (perforation 67 %)
- Three-point lock
- Lockable side covers
- Lockable rear cover
- Cable inlets in the top and in the bottom (300 × 65 mm)
- Light grey colour RAL 7035
- Coverage degree IP 20 to EN 60529

## ▶ RECOMMENDED ACCESSORIES

- Ventilation
- Brush inlets
- Inlet panels
- Bases
- Castors
- Spacer legs
- Shelves and mounting subracks
- Blinding panels
- Supporting panels
- Supporting grids
- Pull-out light
- Circuit breaker panel
- Power supply leads
- Earthing bridge
- Other accessories on the pages D94–D97

# MSS 22U/55 | OUTDOOR DATA CABINET

▶ The case is designed for the installation of 19" outdoor technology. The design of the case enables opening of side covers which considerably simplify the installation of the technology. The case may be fitted with an air-conditioning unit upon customer's request.

- ▶ Enables the installation of 19" technology
- ▶ Basic dimensions 1700 × 600 × 600 mm
- ▶ Coverage degree IP 55 to EN 50102



## ▶ BASIC VERSION

- Base dimensions of 600 × 600 mm
- Physical height of the stand: 600 mm
- Physical height of the case without the stand: 1.100 mm
- Installation height 22U
- Side covers may be opened during installation
- 2 pairs of sliding vertical 19" rails
- Three-point lock
- Thermal insulation
- Heating equipped with a thermostat
- 1 × ventilator (220 V) equipped with a thermostat
- PG openings in the bottom
- Coverage degree IP 55 to EN 50102
- Material: stainless steel sheet
- Light-grey finish RAL 7035

## ▶ ORDER CODES

Order Code	Notes
8622.00/2200F	MSS 22U/55

For other variants, please, contact our sales department.

## ▶ INFORMATION

For other variants, please, contact our sales department.

▶ The SAP 3 data cabinet is designed for the installation of passive and active 21" or 19" outdoor technology. The data cabinet is prepared for mounting air-conditioning unit attached on the door.

- ▶ Double-walled construction with thermal insulation
- ▶ Riveted frame
- ▶ Non-removable rear and side covers
- ▶ Solid base with panels with bushings
- ▶ Perforated ceiling with the possibility of blinding when using air-conditioning unit
- ▶ Roof with front perforation
- ▶ Grounding bus
- ▶ Installation on a plastic base
- ▶ Installation high 48SU (approx. 27U)
- ▶ It is placed on the socle for the placement of cables



## ▶ BASIC VERSION

- 2 pairs of sliding vertical 21" rails
- Four-point lock (type 1670 – two-point lock)
- Installation high 48SU
- Thermal insulation
- Heating equipped with a thermostat
- Ventilator
- Reduction of 19" mounting rails, high 1U
- Reduction of 19" mounting rails, high 2U
- Reduction of 19" mounting rails, high 3U
- Coverage degree IP 54 to EN 50102
- Material: Galvanized sheet
- Colour Light grey RAL 7035
- Dimensions 1870 × 800 × 591 mm
- Dimensions – stand 350 × 800 × 591 mm

## ▶ ORDER CODES

Order Code	Notes / Poznámka
On request	Cabinet 1870 without air conditioning, door equipped with dust filter (right door opening on request)
On request	Cabinet 1870 with door preparation for air conditioning 1400W (right door opening on request)
On request	Cabinet 1670 without air conditioning, door equipped with dust filter (right door opening on request)
On request	Cabinet 1670 with door preparation for air conditioning 850 W (right door opening on request)

For other variants, please, contact our sales department.

# SAP 4 1500 SAP 4 2000 | OUTDOOR DATA CABINET

Outdoor data cabinet SAP 4 1500/2000 allows installation of the passive and active technology into 19" rails.

- ▶ 19" technology 20U/31U
- ▶ Hinged rack with space for documents
- ▶ Profile shelves for a second set of accumulators
- ▶ 4 lifting ears for the transport by crane
- ▶ Optional disassembling the cabinet for the transport without crane
- ▶ Door fixation in the open position (130°)
- ▶ Cooling by ventilator up to 800 m<sup>3</sup>/h
- ▶ Heating 400 W
- ▶ PLC LOGO regulation (Ethernet)
- ▶ Optional electrical and regulation equipment based on request
- ▶ DIN rails for electrical devices – 30 positions
- ▶ Gland system BST (18×5–12 mm + 16×13–23 mm)
- ▶ Aluzinc sheet
- ▶ Lock 2/4 points, lock semi-cylinder 31 mm
- ▶ Lighting
- ▶ Isolation – PIR plate 30 mm



SAP 4 2000



SAP 4 1500

## ▶ BASIC VERSION

Base dimension: 700 × 700 mm

Plinth height: 150 mm

Cabinet height: 1500/2000 mm

Installation height (1 set of batteries): 20U/31U

Installation height (2 set of batteries): 12U/23U

Door locking: 2/4-point, lock semi-cylinder 31 mm

Weight: 139/165 kg

Bushing: BST system (18×5–12 mm + 16×13–23 mm)

Coverage degree: IP54 according to ČSN EN 60529

Material Cabinet: Aluzinc sheet metal

Colour: Epoxy-polyester RAL 7035 (light grey)

Isolation: PIR plate 30 mm thick  $\lambda_0 = 0.022$  W/mK

Lifting ears: 4 lifting ears under the detachable

Operating temperature: -25 to +35 °C

Electric connection:

Covering IP20, Nominal voltage 3NPE, AC 50Hz, 400/230V, TN-C-S, Protection from dangerous voltage according to ČSN 332000-4-41ed.2: Live parts: isolation, covers, desk. Non-live parts: automatic disconnecting from power.

Additional: current protector.

## ▶ ORDER CODES

Order Code	Notes
On request	SAP 4 1500
On request	SAP 4 2000

For other variants, please, contact our sales department.

▶ The MTS 3 heavy duty transport box is designed for use of 19" technology and can be used in difficult operating conditions, such as aviation, railway and waterway transport.

The inner frame is placed on antivibration elements which together with its outer casing, ensure high resistance to mechanical vibration. The removable lids give an easy access to 19" technology, and the embedded panel of the rear lid enables the installation of connectors and other connecting elements. The transport box is equipped with an atmospheric pressure equalizing valve, which is activated automatically when the closing elements are opened. The inner box frame itself, as well as the application of HF conductive packing around both lids, meets the electromagnetic compatibility (EMC) requirements.

- ▶ Transport of 19" technology
- ▶ Height of 4U, 6U and 12U
- ▶ Enables the stacking of transport boxes
- ▶ EMC requirements fulfilment
- ▶ Protection from the weather effects
- ▶ Protection from dust
- ▶ Pressure equalizing valve
- ▶ Coverage degree IP 65 to EN 60529
- ▶ Dark green colour



## ▶ ORDER CODES

Order Code	Base dimensions [mm]	Height [mm]	Height [U]	Weight [kg]	Loading capacity [kg]	Notes
8B20.00/040DZ50	570 × 540	290	4	11	50	
8B20.00/060DZ50	570 × 540	380	6	16	50	
8B20.00/120DZ2035	570 × 540	740	12	30	50	Sectional frame

For other variants, please, contact our sales department.



▶ These data cabinets are special products and designed to increase the reliability of the installed technology. Cabinets with increased protection will also find use in the protection of information systems, both from the disturbing effects of an electromagnetic environment and from any possible leak of important data.

The base of the BS line cabinets is a self-supporting welded construction conceived mainly for the installation of 19" technology.

- ▶ Construction according to individual clients' requirements
- ▶ Up to IP 65 coverage degree to EN 60529

## Services offered in the sphere of EMC

The TELCOM division also offers a wide range of services in the EMC sphere. A trained team will recommend a solution suitable for your needs and we offer expert consulting and training, analyses and even complete solutions for technical projects.



### ▶ RECOMMENDED ACCESSORIES

Racks and mounting subracks

Blinding panels

Supporting panels

Circuit breaker panel

Power supply leads

Filters with or without a dust insert

Waveguide inlets

Cable waveguide inlets

Closing mechanisms

Mains EMC screens

Data and telephone EMC screens

Ventilation

Other accessories on the pages D94–D97

### ▶ INFORMATION

For further information, please, contact our sales department. / Pro více informací kontaktujte naše obchodní oddělení.

## BASE

The bases are provided with three breakable inlets (300 × 65 mm).

### ORDER CODES

Order Code	Suitable for	Base dimensions [mm]	Height [mm]	Colour
8872.38/10A1F	MSS	600 × 600	120	RAL 7035 lt. gray
8872.38/10D1F	MSS	600 × 800	120	RAL 7035 lt. gray
8872.38/10B1F	MSS	800 × 800	120	RAL 7035 lt. gray

For other variants, please, contact our sales department.



## SPACER LEGS

The spacer legs, with adjustable height and inclinable surface contact, allow for the possible unevenness of the floor.

### ORDER CODES

Order Code	Setting range [mm]	Loading capacity [kg]	No. in one pack
8A62.97/0000F	0–25	400	4

For other variants, please, contact our sales department.



## CASTORS

The castors wheels make the handling of the MSS stand cabinets and MKS collocation cabinets easier.

### ORDER CODES

Order Code	Loading capacity [kg]	No. in one pack
8A62.96/0000F	300	2 with a brake, 2 without a brake
8A62.96/0003F	600	2 with a brake, 2 without a brake

For other variants, please, contact our sales department.



## 2U MOUNTING SUBRACK

The mounting subrack is designed for fastening various technological elements.



### ORDER CODES

Order Code	Height [U]	Colour
8A63.00/0005F	2	Black

For other variants, please, contact our sales department.

## RACKS

The racks are designed for placing the technology inside the data and collocation cabinets. The loading capacity stated for rack 500 and rack 600 is applicable when 2 supporting angles are used (angle 50 or angle 400).

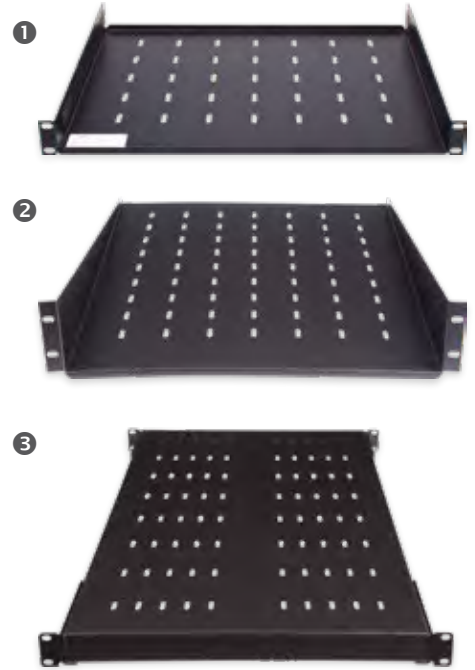

### ORDER CODES

Order Code	Depth [mm]	Height [U]	Loading capacity [kg]	Colour	Notes	Position
8A06.10/00B5F	255	1	10	Black		–
8A29.35/00B5F	350	1	10	Black		1
8A06.00/0005F	255	2	10	Black		–
8A29.00/1005F	400	1	10	Black		–
8A07.00/0005F	400	2	10	Black		2
8A18.00/0005F	500	2	40	Black		–
8A91.00/0005F	600	2	40	Black		–
8A05.20/65B5F	650	1	40	Black	*	3
8A05.20/85B5F	850	1	40	Black	*	–

\*) Only for MSS

For other variants, please, contact our sales department.

## POWER SUPPLY LEADS

For the power supply of the installed technology, we offer a series of power supply leads, protected/ unprotected, with different types of sockets.



### ORDER CODES

Order Code	Name	Number of sockets	Over-voltage protection	HF screen	Power supply cable [m]	Installation to rails	Position
8A73.00/0005F	Protected extension lead	5	Yes / Ano	Yes / Ano	3	Yes / Ano	1
8A74.00/0005F	Protected extension lead	5	Yes / Ano	Yes / Ano	5	Yes / Ano	–

For other variants, please, contact our sales department.

## 3U CIRCUIT BREAKER PANEL

The circuit breaker panel is designed for mounting electrical installation elements onto the DIN ribbon.



### ORDER CODES

Order Code	Height [U]	Colour
8A30.00/0005DIN-----	3	Black

For other variants, please, contact our sales department.



## 19" ETSI ADAPTOR

This adaptor allow 19" technology to be installed into the ETSI frame.



### ORDER CODES

Order Code	No. in one pack	Height [U]	Colour
8821.50/0100F	2	1	Black
8873.23/0205F	2	2	Black
8A06.60/0305F	2	3	Black

For other variants, please, contact our sales department.



## CONNECTING MATERIAL



### ORDER CODES

Order Code	Name	Description
8872.05/0000F	MSS connecting packing	For connection frames of MSS
8872.12/B0A0F	Bar brackets	Increase of the rigidity of MSS and MKS
8872.12/B0B0F	Bar brackets	Increase of the rigidity of MSS and MKS
390100	M5 packing	4× screw M5, washer, M5 nut
8A62.78/0000F	M5 packing	20× screw M5, washer, M5 nut
390200	M5 packing	4× screw M6, washer, M6 nut
8A62.66/0000F	M5 packing	20× screw M6, washer, M6 nut

For other variants, please, contact our sales department.



## RANGING PANELS



The ranging panels are designed for leading cables inside the data and collocation cabinets.

- ▶ The ranging panels are designed for horizontal leading cables
- ▶ Installation on a 19" base
- ▶ Installation height 1U or 2U
- ▶ One-sided or two-sided supports
- ▶ Plastic cable rings 40/50, 40/80, 80/80



### ORDER CODES

Order Code	Name	Height [U]	Description	Position
8A82.04/0005F	1U ranging panel (without cable rings)	1	For plastic rings of 40 × 50 and 40 × 80 mm	2
8A82.05/0005F	2U ranging panel (without cable rings)	3	For plastic rings of 80 × 80 mm	1
8A58.00/0105F	Wire channel	1		
	Plastic cable rings 40/50, 40/80, 80/80		See Cable Clips	

For other variants, please, contact our sales department.

# EXAMPLES OF INSTALLATIONS





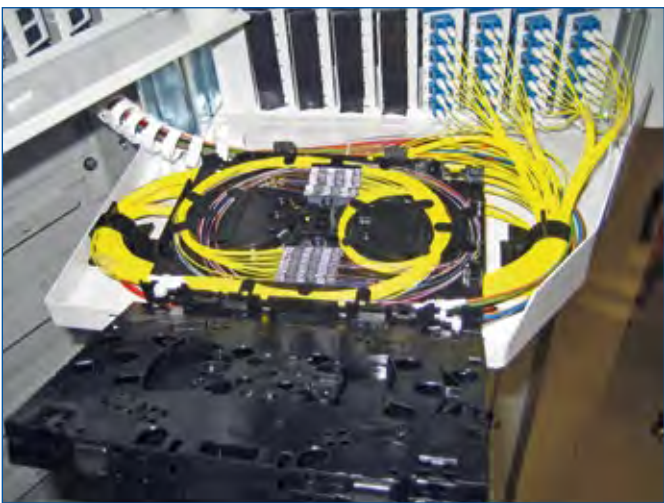

## PLP Asia Pacific Regional Office Locations

### PLP Australia

Preformed Line Products  
190 Power Street  
Glendenning NSW 2761  
Australia  
Ph: +61 2 8805 0000  
Fax: +61 2 8805 0090  
Email: [sales@preformed.com.au](mailto:sales@preformed.com.au)  
[www.preformed.com.au](http://www.preformed.com.au)

### PLP New Zealand

Preformed Line Products  
35 Lady Ruby Drive  
East Tamaki, Manukau, Auckland 2013  
New Zealand  
Ph: +64 9 274 2000  
Fax: +64 9 274 2001  
Email: [mail@preformed.co.nz](mailto:mail@preformed.co.nz)  
[www.preformed.co.nz](http://www.preformed.co.nz)

### PLP Vietnam

Preformed Line Products  
No. 9A, Street 53, Zone 5  
Tan Phong Ward  
District 7, Ho Chi Minh City  
Vietnam  
Ph: +84 28 3939 3927  
Fax: +84 28 3824 3929  
Email: [sales@preformed.asia](mailto:sales@preformed.asia)  
[www.preformed.com/th](http://www.preformed.com/th)

### PLP China

Preformed Line Products  
#1 Guohuai Jie Development Zone  
Liangxiang, Beijing 102488  
China PRC  
Ph: +86 10 8936 0860  
Fax: +86 10 8936 0866  
Email: [plp@plp.com.cn](mailto:plp@plp.com.cn)  
[www.plp.com.cn](http://www.plp.com.cn)

### PLP Malaysia

Preformed Line Products Sdn. Bhd.  
No. 3, Jalan BK 1/11  
Kinrara Industrial Park  
Bandar Kinrara  
47100 Puchong  
Selangor Darul Ehsan  
Malaysia  
Ph: +60 3 807 65922  
Fax: +60 3 807 64922  
Email: [my.sales@preformed.asia](mailto:my.sales@preformed.asia)  
[www.preformed.asia/Malaysia](http://www.preformed.asia/Malaysia)

### PLP Indonesia

PT Preformed Line Products  
Jl. Irian VII Blok MM-4-2  
Kawasan Industri MM2100  
Cikarang - Bekasi 17520  
Jawa Barat  
Indonesia  
Tel: +62 21 8593 3899  
Fax: +62 21 893 4964  
Email: [id.sales@preformed.com](mailto:id.sales@preformed.com)  
[www.preformed.com/id](http://www.preformed.com/id)

### PLP Thailand

Preformed Line Products  
296 Moo 4, Ladkrabang  
Industrial Estate, EPZ 3  
Chalongkrung Road, Lamplatew  
Ladkrabang, Bangkok 10520  
Thailand  
Phone: +66 2 739 4026  
Fax: +66 2 326 0564  
Email: [sales@preformed.asia](mailto:sales@preformed.asia)  
[www.preformed.asia/Thailand/](http://www.preformed.asia/Thailand/)